

® Directions for Use
Grass Trimmer



GARDENLINE

7



Art.-No.: 34.112.21

I.-No.: 01014

GLLT **18**



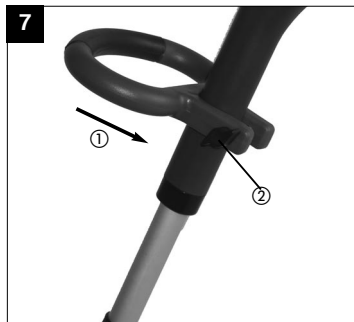
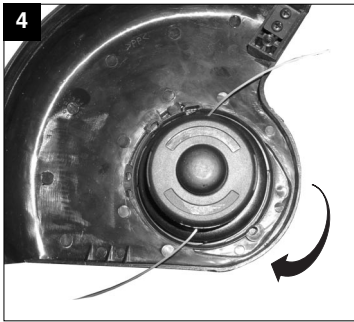
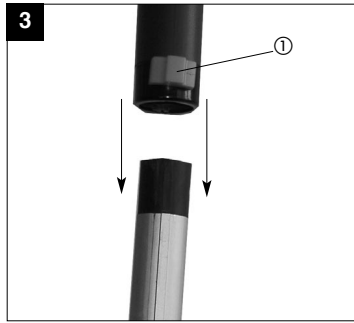
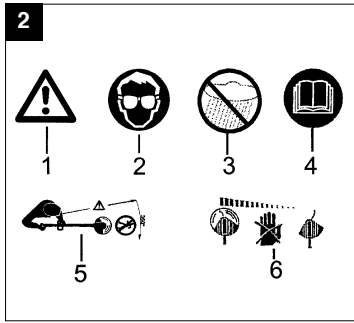

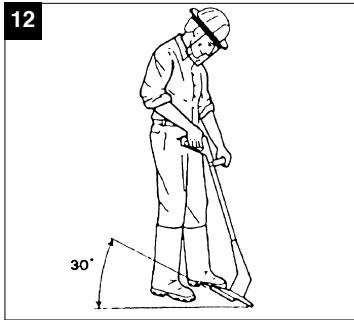
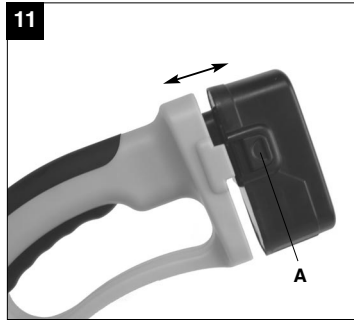
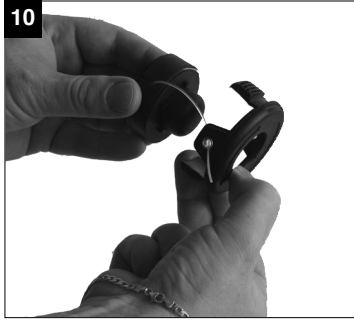

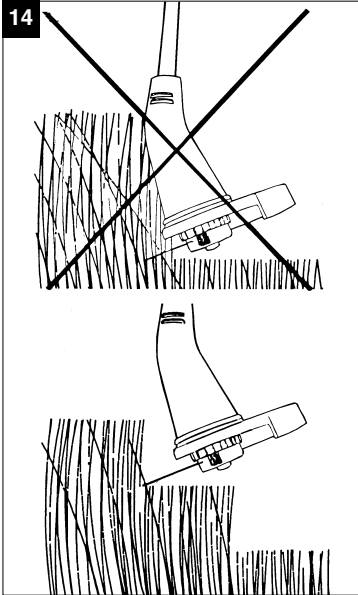

GB**1. Layout (Fig. 1)**

1. Rechargeable battery (18 volts)
2. ON/OFF switch
3. Additional handle with screw
4. Button to dismantle the appliance
5. Rotary knob for height adjustment
6. Line spool
7. Safety cover
8. Power supply unit
9. Charging adapter

2. Important notes

Please read the instructions for use carefully and observe the information provided. It is important to consult these instructions in order to acquaint yourself with the tool, its proper use and safety precautions.

Important!

Do not allow children to use the Grass Trimmer.

Safety information

Please refer to the booklet included in delivery for the relevant safety instructions.

Additional safety instructions

- Inspect the items you want to cut before starting to work. Remove any foreign objects. If you hit an obstacle while cutting, turn off the machine and remove the obstacle.
- Work only in good visibility.
- Always make sure of your footing while working. Be careful when stepping backwards. Risk of stumbling!
- Never leave the tool unattended at your work place. Store the tool in a safe place during interruptions.
- If you interrupt your work to move to a different position it is imperative you switch off the tool while you are moving there.
- Never use the tool in the rain or in moist or wet conditions.
- Protect the tool from the damp and rain.
- Before you switch on the tool, make sure that there are no stones or other objects touching the nylon line.
- Always wear suitable clothing to protect your head, hands and feet from injury. Wear a helmet, goggles or visor, high boots or strong shoes, long trousers made of tough material, and work gloves.
- Be sure to hold the tool away from your body when it is switched on!
- If the tool is turned over or if it is not in working position, do not switch it on.
- Switch off the motor when you are not using the tool, when you leave the tool unattended, when you are checking the tool, if the power cable is damaged, when you want to remove and replace the reel, and when you are moving the tool to another location.
- Keep the tool away from other persons, particularly children and pets. There may be stones and other objects in the flying cut grass.
- Keep at least 5 m away from other persons and animals when you are working with the tool.
- To prevent injury to yourself and damage to the tool, never cut against hard objects.
- Use the edge of the guard to keep the tool away from walls, changes of surface and fragile objects.
- Never use the tool without a guard.

⚠ CAUTION! The guard is vital for your safety and for the safety of others, and it is also essential for the grass trimmer to work correctly. Failure to observe this instruction will not only create a potential hazard, it will also result in the loss of your rights under the warranty.

- Never try to stop the cutter (nylon line) with your hands. Wait until it stops by itself. It is imperative to use only the original nylon line.
- Never use metal wire instead of the nylon line. Beware of injuring yourself on the line cutting device. Keep the air vents clear of dirt. After use, unplug the machine and check it for damage.
- Never attempt to cut grass that is not growing on the ground. For example, do not try to cut grass growing on walls, rocks, etc. Within the working radius of the grass trimmer the user is responsible for any damage caused to third persons by use of the trimmer.
- Never cross roads or pebble paths with the grass trimmer switched on.
- When you are not using the grass trimmer, keep it in a dry place out of the reach of children.

- Use the grass trimmer only as described in these directions for use and always hold it vertical to the ground. All other positions are dangerous.
- Check the screws regularly to see that they are properly tightened.
- Keep cables and other objects out of the area you want to cut.
- If you have to lift the grass trimmer to move it, switch off the motor and wait for the rotating tool to stop.
- Before you connect the grass trimmer to the power supply, make sure that none of its moving parts are damaged and that the line spool is correctly inserted and fastened.
- Never cut against hard objects when using the grass trimmer. This is imperative to avoid causing injury to the user and damage to the trimmer.
- Use only original replacement parts for repair and maintenance purposes.
- Examine the grass trimmer for signs of wear or damage each time before you use it and after any collisions. Have essential repairs carried out without delay.
- Always keep your hands and feet away from the cutting mechanism, particularly when you switch on the trimmer.
- After pulling out new line, always return the trimmer to normal working position before you switch it on again.
- Never use replacement parts or accessories which are not foreseen or recommended by the manufacturer.
- Unplug the rechargeable battery before checking, cleaning or doing any work on the machine and when it is not being used.

⚠ Caution! The nylon line will run on for a few seconds after the tool is switched off!

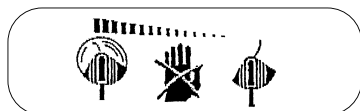

3. Explanation of the warning notice (see Figure 2) on the grass trimmer

- 1: Caution!
- 2: Wear safety goggles!
- 3: Protect from the damp!
- 4: Read the directions for use before putting into operation for the first time!
- 5: Keep third parties away from the danger zone!
- 6: The tool runs on after being switched off!

4. Technical data

Speed:	10.000 rpm
Cutting range:	25 cm diameter
Max. running period:	approx. 30 min
Nylon cutting line Ø	1,2 mm
Type of protection:	III
Sound power level LWA:	88 dB(A)
Sound pressure level LPA:	79 dB(A)
Replaceable NC battery:	18 V
Vibration A _{vh} :	< 2,5 m/s ²
Power supply unit:	
Mains voltage:	230-240 V ~ 50 Hz
Output:	
Rated voltage:	23 V
Rated current:	400 mA

The noise level of this machine may exceed 85 dB(A). In this case, noise protection measures need to be introduced for the user. The machine's noise was measured in accordance with IEC 59 CO 11, IEC 704, DIN 45635 Part 21, NFS 31-031 (84/538/EEC). The level of vibrations emitted from the handle is < 2,5 m/s². Measurements were taken in accordance with EN 786 part D: 1996+A1:2001.

5. Assembling the grass trimmer

- **To install the handle on the telescopic tube**
Fit the handle on the telescopic tube and insert it as far as possible (Figure 3). The button (1) will engage automatically.
- **To install the safety hood**
Place the safety hood on the motor head (Figure 4) and then turn it clockwise until it engages (Figure 5). Secure it with the screws supplied (Figure 5).

GB

- **Assembly of the handle**

The handle is assembled as shown in Fig. 7. Refer to the numbers for the correct assembling order.

6. Proper use

The trimmer is designed for cutting lawns and small areas of grass. Tools for private use are not suitable for use in public facilities, parks and sport centers, along roadways, on farms or in the forestry sector. For the tool to be used properly it is imperative to follow the instructions set out in the manufacturer's directions for use.

Important! It is prohibited to use the tool to chop material for composting because of the potential danger to persons and property.

7. Before starting

You can adjust the height of the grass trimmer and the position of the auxiliary handle to obtain the optimal working position.

Height adjustment

Place the grass trimmer on a firm surface. You can adjust its height to suit your own height by undoing the rotary knob (Figure 6 Item 1) and then adjusting the telescopic tube. Then tighten the rotary knob again.

8. Starting for the first time and operation

The grass trimmer is designed only for cutting grass. A short or worn nylon line will result in poor cutting performance.

IMPORTANT! Make sure that you unplug the rechargeable battery before adjusting the line length (Fig. 11)!

The grass trimmer has a semi-automatic line extension system. Each time you activate the semi-automatic line extension system, the line will be extended to ensure that you can cut your lawn with the perfect cutting width at all times. Please note that the wear on the line will be increased if you activate the semi-automatic line extension system frequently.

Note

If the line is too long when you use the machine for the first time, the surplus end of it will be cut

by the blade on the safety hood.

If the line is too short when you start the machine for the first time, press the knob on the line spool and pull the line hard. When you then start the machine for the first time the line will be cut to the perfect length automatically.

Remove the knife guard. Caution: Risk of injury! Now insert the rechargeable battery (Fig. 11). The line will be cut to the correct length when the cutting head starts up again. A short or worn nylon line produces poor cutting results.

Your grass trimmer will work at its best if you observe the following instructions:

- Never use the grass trimmer without its safety devices.
- Do not cut grass when it is wet. The best results are had on dry grass.
- To switch on your grass trimmer, press the safety lock-off and the ON/OFF switch (Fig. 1/Pos. 2).
- To switch off your grass trimmer, let go of the ON/OFF switch (Fig. 1/Pos. 2).
- Do not move the grass trimmer against the grass until the switch is pressed, i.e. wait until the trimmer is running.
- For the correct cutting action, swing the grass trimmer to the side as you walk forward, holding it at an angle of approx. 30° as you do so (see Figure 12-13).
- Make several passes to cut long grass shorter step by step from the top (see Figure 14).
- Make full use of the guide hood in order to avoid unnecessary line wear.
- Keep the grass trimmer away from hard objects in order to avoid unnecessary line wear.

9. Replacing the line spool

IMPORTANT! Make sure that you unplug the rechargeable battery before replacing the line spool (Fig. 11)!

- Attach the knife guard.
- Press the sides of the spool cover as shown and remove it with the spool (Figure 8+9). Ensure that you do not lose the spring.
- Remove the empty line spool.
- Thread the ends of the line on the new line spool through the eyelets in the spool cover (fig. 10)
- Fit the spool cover and spool back into the spool mounting.
- Remove the knife guard. Caution: Risk of injury.

- The line will be cut to the correct length when the cutting head starts up again.

Caution! Catapulted pieces of nylon line may cause injury!

10. Charging the rechargeable battery

- You can remove the rechargeable battery by firmly pressing both locking tabs (A) while pulling out the battery (Fig. 11).
- Check to see if the voltage specified on the rating plate of the charging unit matches the mains voltage. Connect the power supply unit to the charging adapter. Plug the power supply unit into the socket outlet. The green LED on the charging adapter lights up.
- Plug the rechargeable battery into the charging adapter. The red LED on the charging adapter lights up and shows the charging process. The time it takes to fully recharge an empty battery is approximately 4 hours, while a partially charged battery takes correspondingly less time. The rechargeable battery can become a little warm during the charging process, which is normal.

If the battery pack fails to charge, please check

- whether there is voltage at the socket-outlet
- whether there is good contact at the charging contacts

If the battery pack still fails to charge, we request that you contact helpline for further advice.

To ensure that the NC battery pack provides long service, you should take care to recharge it promptly. You must recharge the battery pack when you notice that the power of the lawn trimmer drops.

Never allow the battery pack to become fully discharged. This will cause it to develop a defect.

11. Cleaning and maintenance

- Switch off and unplug the grass trimmer before putting it away or cleaning it.
- Remove deposits from the guard hood with a brush.
- Clean the plastic body and plastic parts with a mild household detergent and a damp cloth.
- Never use aggressive agents or solvents for cleaning purposes!
- Never spray the grass trimmer with water.
- Prevent water getting into the trimmer at all cost.

IMPORTANT: Remove the rechargeable battery first (Fig. 11).

12. Ordering replacement parts

When ordering replacement parts, please quote the following data:

- Type of product
- Article number of the product
- ID number of the product
- Number of the required replacement part

Line spool 34.051.54

13. Faults

- The device does not operate: Check whether the rechargeable battery is charged and whether the battery charger works. If the device still does not work even with a voltage supply, please contact Helpline No. for further advice.

14. Waste disposal

Important

- The grass trimmer and its accessories are made of various types of material, such as metal and plastic. Defective components must be disposed of as special waste. Contact your Local Authority for safe battery disposal advice.

ISC GmbH
Eschenstraße 6
D-94405 Landau/Isar

declaration of conformity



- | | |
|--|---|
| <p>(D) erklärt folgende Konformität gemäß EU-Richtlinie und Normen für Artikel</p> <p>(GB) declares conformity with the EU Directive and standards marked below for the article</p> <p>(F) déclare la conformité suivante selon la directive CE et les normes concernant l'article</p> <p>(NL) verklaart de volgende conformiteit in overeenstemming met de EU-richtlijn en normen voor het artikel</p> <p>(E) declara la siguiente conformidad a tenor de la directiva y normas de la UE para el artículo</p> <p>(P) declara a seguinte conformidade de acordo com a directiva CE e normas para o artigo</p> <p>(S) förklarar följande överensstämmelse enl. EU-direktiv och standarder för artikeln</p> <p>(FIN) ilmoittaa seuraavaa Euroopan unionin direktiivien ja normien mukaista yhdenmukaisuutta tuotteelle</p> <p>(DK) erklærer herved følgende samsvare med EU-direktiv og standarder for artikellet</p> <p>(BG) заявяват о съответствии товара следуюцим директивам и нормам EC</p> <p>(HR) izjavljuje sljedeću uskladenost s odredbama i normama EU za artikl.</p> <p>(RO) declară următoarea conformitate cu linia directoare CE și normele valabile pentru articolul.</p> | <p>(TR) ürün ile ilgili olarak AB Yönetmelikleri ve Normları gereğince aşağıdaki uygunluk açkila masini sunar.</p> <p>(GR) δηλώνει την ακόλουθη συμφωνία σύμφωνα με την Οδηγία ΕΕ και τα πρότυπα για το προϊόν</p> <p>(I) dichiara la seguente conformità secondo la direttiva UE e le norme per l'articolo</p> <p>(DK) atstæter følgende overensstemmelse i henhold til EU-direktiv og standarder for produkt</p> <p>(CZ) prohlašuje následující shodu podle směrnice EU a norem pro výrobek.</p> <p>(H) a következő konformitást jelenti ki a termékerek vonatkozó EU-irányvonalak és normák szerint</p> <p>(SD) pojasňuje sledečo skladnost po smernici EU in normah za artikel.</p> <p>(PL) deklaruje zgodność wymienionego poniziej artykułu z następującymi normami na podstawie dyrektywy WE.</p> <p>(SK) vydáva nasledujúce prehlásenie o zhode podľa smernice EÚ a noriem pre výrobok.</p> <p>(BG) декларира следното съответствие съгласно директивите и нормите на ЕС за продукта.</p> |
|--|---|

Grass Trimmer GLLT 18

- | | |
|--|--|
| <input checked="" type="checkbox"/> 98/37/EG | <input type="checkbox"/> 87/404/EWG |
| <input checked="" type="checkbox"/> 73/23/EWG_93/68/EEC | <input type="checkbox"/> R&TTED 1999/5/EG |
| <input type="checkbox"/> 97/23/EG | <input checked="" type="checkbox"/> 2000/14/EG: <small>gemessener Schalleistungspegel L_{WA} = 85 dB
garantierter Schalleistungspegel L_{WA} = 88 dB
Ø = 25 cm</small> |
| <input checked="" type="checkbox"/> 89/336/EWG_93/68/EEC | <input type="checkbox"/> 95/54/EG: |
| <input type="checkbox"/> 90/396/EWG | <input type="checkbox"/> 97/68/EG: |
| <input type="checkbox"/> 89/686/EWG | |

EN 786+A1; EN 60745-1+A1; EN 55014-1+A1+A2; EN 55014-2+A1; EN 61000-3-2;
EN 61000-3-3+A1; EN 60335-2-40/A1; EN 60335-2-29+A11;
EN 60335-1+A1+A2+A11-A16

TÜV Süddeutschland Bau und Betrieb; KBV VI; OR/10535/04

Landau/Isar, den 16.12.2004

[Signature]
Wechseltgärtner
Leiter QS Konzern

[Signature]
Ensing
Leiter Technik EC

Art.-No.: 34.112.21 I.-No.: 01014
Subject to change without notice

Archivierung: 3411220-06-4175500-E

GARANTIEURKUNDE

Auf das in der Anleitung bezeichnete Gerät geben wir 2 Jahre Garantie, für den Fall, dass unser Produkt mangelhaft sein sollte. Die 2-Jahres-Frist beginnt mit dem Gefahrenübergang oder der Übernahme des Gerätes durch den Kunden. Voraussetzung für die Geltendmachung der Garantie ist eine ordnungsgemäße Wartung entsprechend der Bedienungsanleitung sowie die bestimmungsgemäße Benutzung unseres Gerätes.

Selbstverständlich bleiben Ihnen die gesetzlichen Gewährleistungsrechte innerhalb dieser 2 Jahre erhalten. Die Garantie gilt für den Bereich der Bundesrepublik Deutschland oder der jeweiligen Länder des regionalen Hauptvertriebspartners als Ergänzung der lokal gültigen gesetzlichen Vorschriften. Bitte beachten Sie Ihren Ansprechpartner des regional zuständigen Kundendienstes oder die unten aufgeführte Serviceadresse.

Helpline-No.:

☎ 0044 (0) 151 649 1500

☎ 189 09 46244

☎ WARRANTY CERTIFICATE

The product described in these instructions comes with a 2 year warranty covering defects. This 2-year warranty period begins with the passing of risk or when the customer receives the product. Please retain receipt as proof of purchase.

For warranty claims to be accepted, the product has to receive the correct maintenance and be put to the proper use as described in the operating instructions.

Your statutory rights of warranty are naturally unaffected during these 2 years.

This warranty applies in Germany, or in the respective country of the manufacturer's main regional sales partner, as a supplement to local regulations. Please note the details for contacting the customer service center responsible for your region or the service address listed below.

☎

The reprinting or reproduction by any other means, in whole or in part, of documentation and papers accompanying products is permitted only with the express consent of ISC GmbH.

☎ Technical specifications subject to change

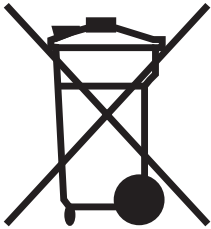

④ Recycling alternative to the demand to return electrical devices:

As an alternative to returning the electrical device, the owner is obliged to cooperate in ensuring that the device is properly recycled if ownership is relinquished. This can also be done by handing over the used device to a returns center, which will dispose of it in accordance with national commercial and industrial waste management legislation. This does not apply to the accessories and auxiliary equipment without any electrical components which are included with the used device.

④ For EU countries only

Never place any electric tools in your household refuse.

To comply with European Directive 2002/96/EC concerning old electric and electronic equipment and its implementation in national laws, old electric tools have to be separated from other waste and disposed of in an environment-friendly fashion, e.g. by taking to a recycling depot.