

GB **Operating Instructions**  
**Petrol Grass Trimmer**

 **SPEAR & JACKSON**

7

**CE**

**Cat-No.: 720-1228**

**34.017.21**

**I.-No.: 01016**

**SPJGT 26**



- Ⓢ Please read these instructions carefully before installing and operating the petrol motor scythe!

### Petrol Engine Quick Start Guide

Ensure correct fuel/oil mixture 40:1

#### STARTING

1. Place the machine on a hard, level surface
2. Set the choke lever to "I + I"  
Note - the amount of Choke will vary slightly depending on the weather conditions, a small amount of experimentation is advised.
3. Press the fuel primer button ten times minimum
4. Set the ON/OFF switch to "I"
5. Secure the throttle lever
6. Pull the starter cable 4 times quickly
7. If the engine has started, set the choke lever immediately to "I + I" and allow the machine to warm up for approx. 10 seconds.
8. Release the throttle lever
9. If the engine does not start, repeat points 7-8  
Note - this quick start guide is intended for experienced users who have already assembled the tool, please refer to the manual for details.

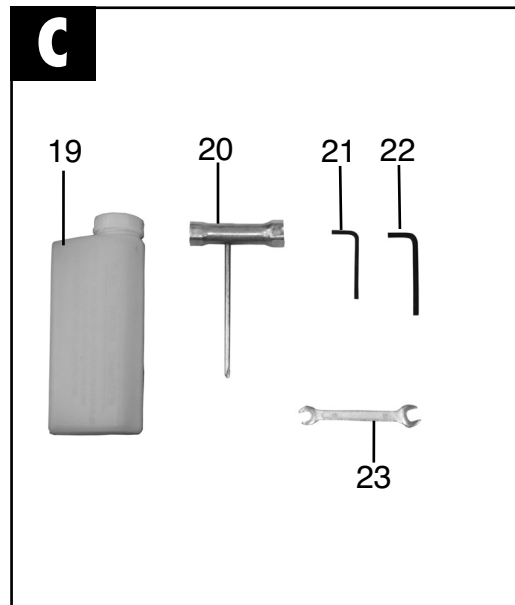
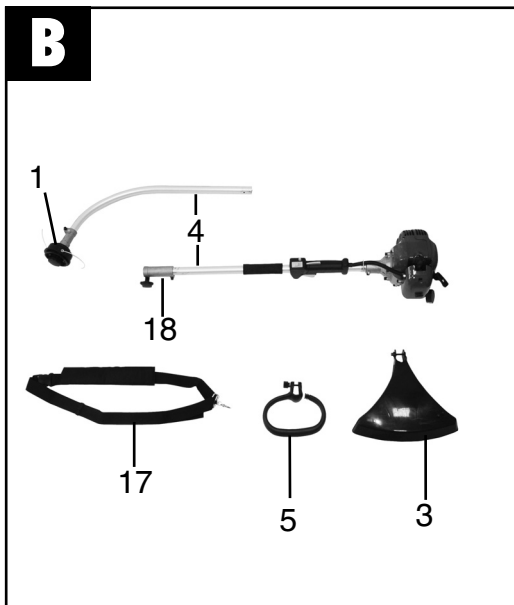
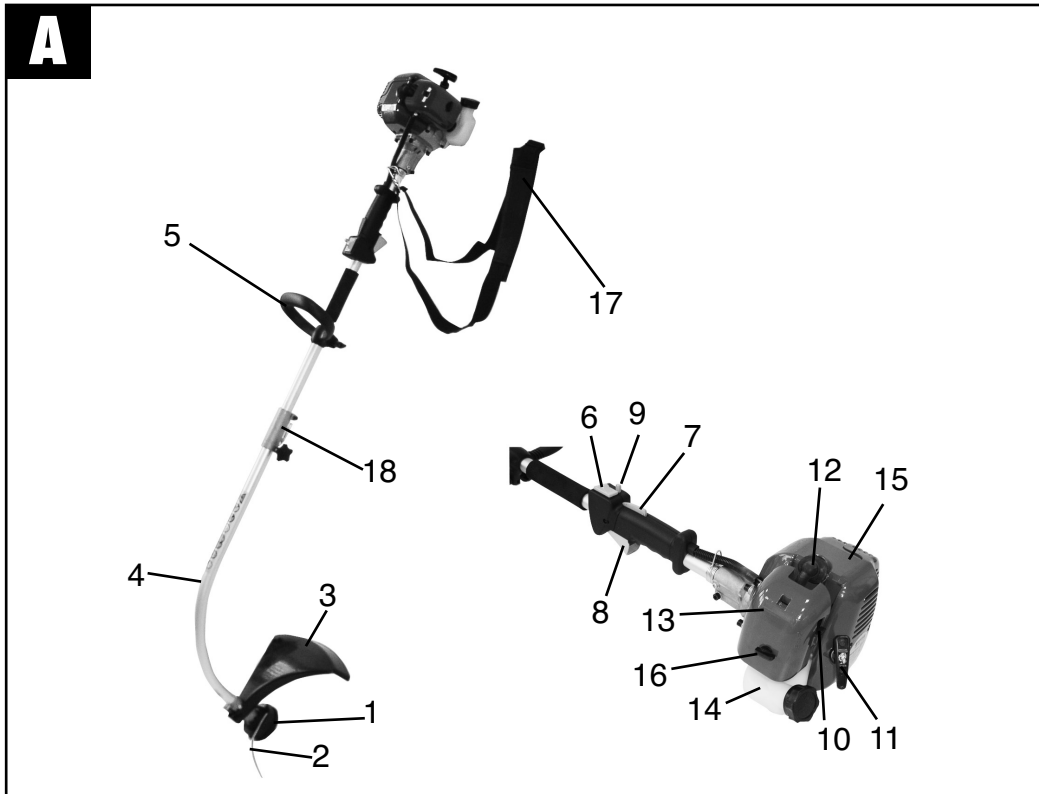

If machine does not start after minimum 6 pulls on starter cord refer to petrol Engine Q & A on page 14.

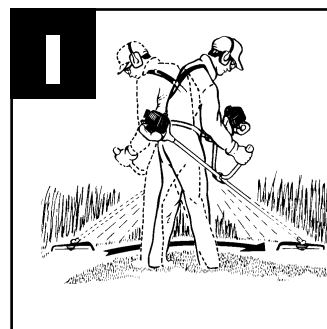
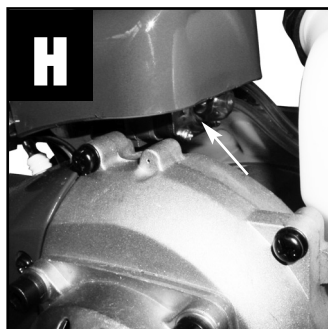
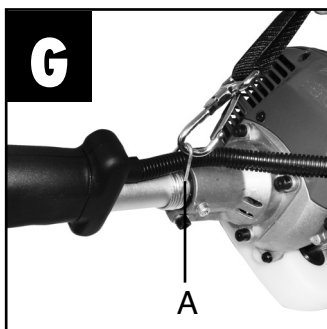
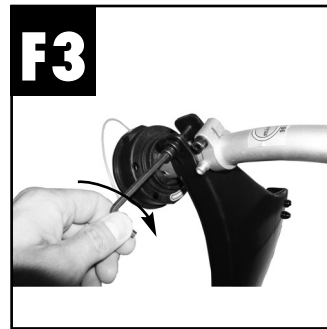
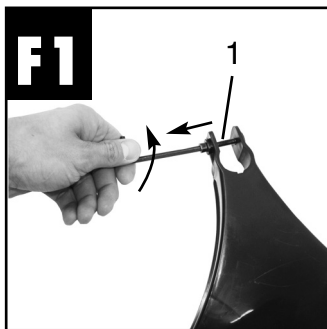
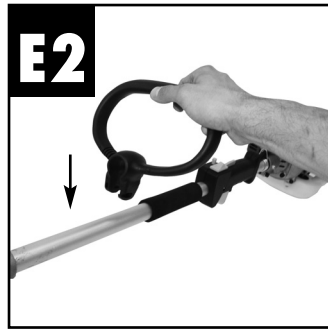
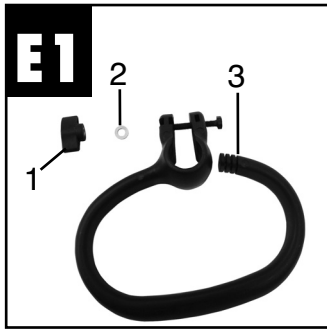
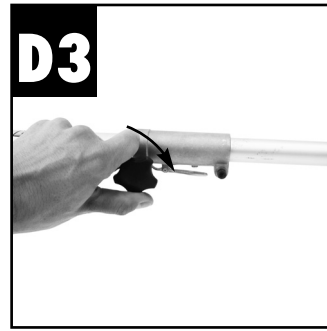
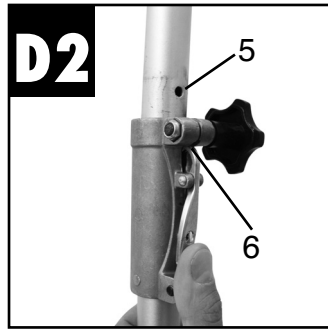
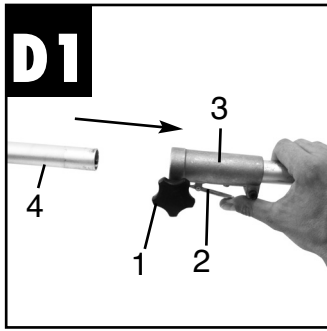

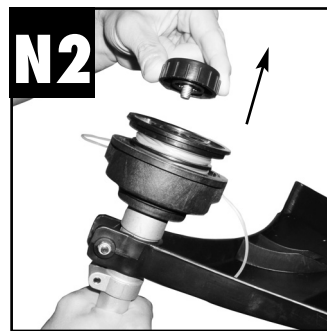
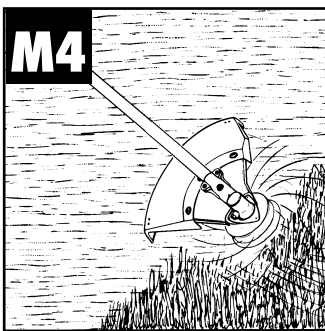
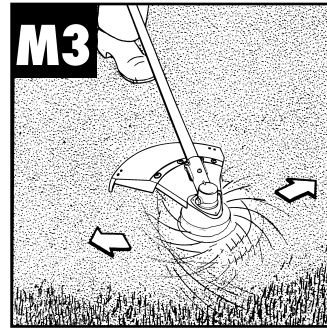
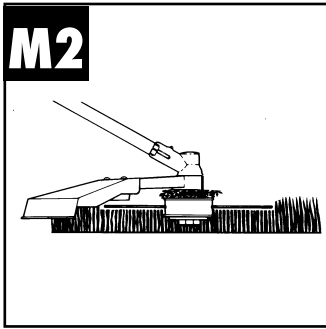
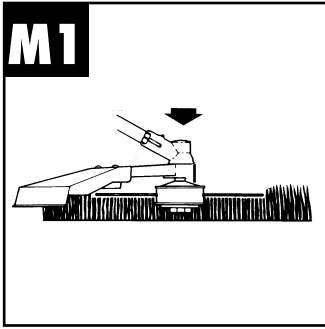
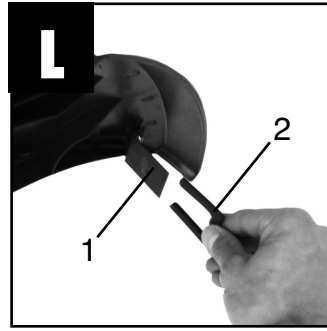
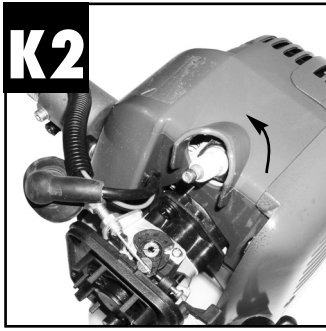
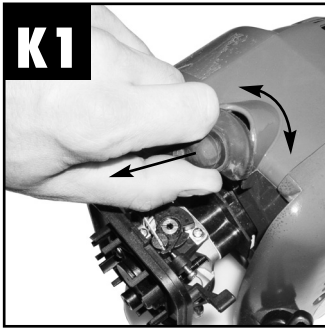
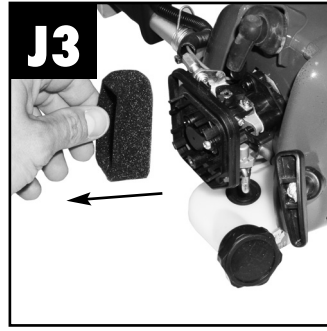
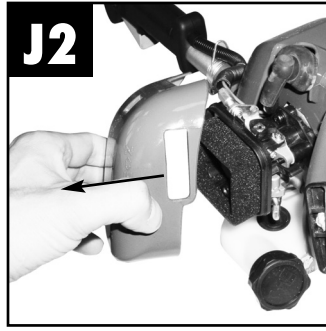
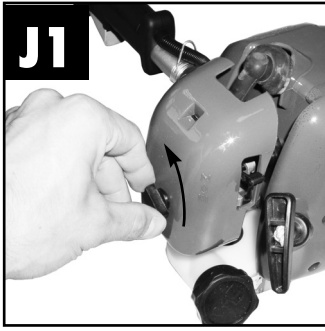

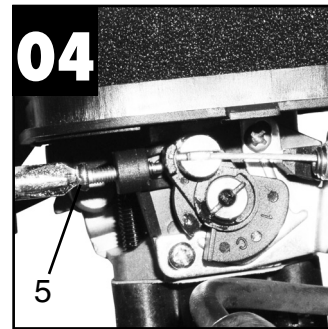
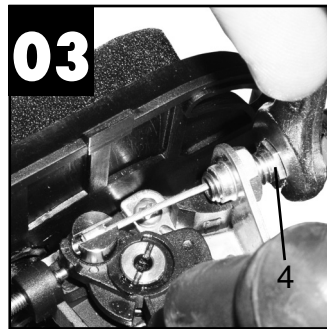
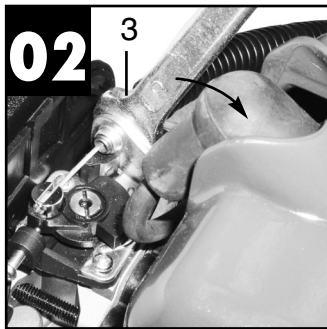
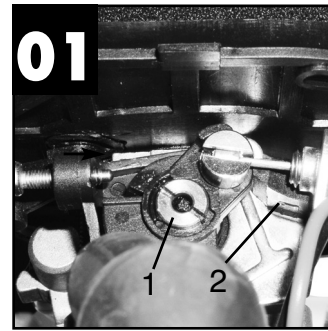
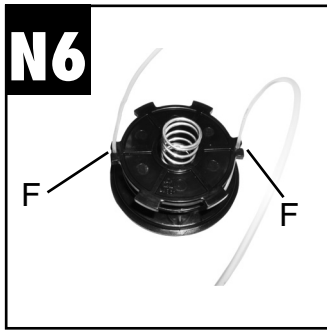
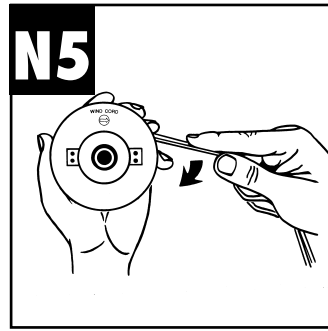
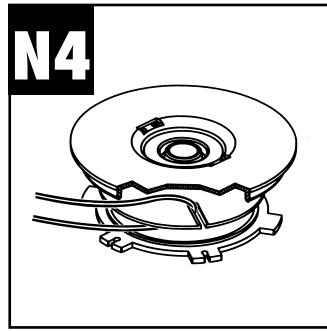
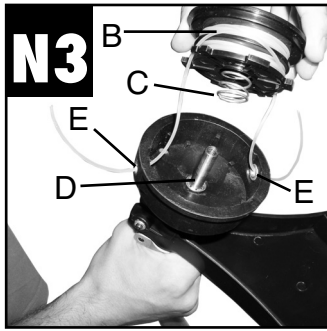



<b>P1</b>		1
		2
		3
		4
		5
		6
		7
		8
		9
		10
		11

**GB**

**Table of contents**

**Page**

1. General safety regulations	9
2. Machine layout and items supplied	11
3. Technical data	11
4. Intended use	11
5. Environmental protection	11
6. Assembly	11
7. Before starting the machine	12
8. Operation	12
9. Maintenance	14
10. Storage	15
11. Disposal	16
12. Ordering replacement parts	16
13. Troubleshooting	17



**When using equipment, a few safety precautions must be observed to avoid injuries and damage.**

- Read the operating instructions carefully and comply with them. It is important to consult these instructions in order to acquaint yourself with the unit, its proper use and safety regulations.
- Keep this manual in a safe place, so that the information is available at all times.
- If you give the equipment to any other person, hand over these operating instructions as well.

**We accept no liability for damage or accidents which arise if these instructions have not been adhered to.**

**1. General safety regulations****Explanation of the information signs on the machine (Fig. P1):**

1. Warning!
2. Read the directions for use before operating the machine.
3. Wear safety goggles, a helmet and ear protection.
4. Wear sturdy, non-slip footwear.
5. Wear safety gloves.
6. Protect the machine from rain and damp.
7. Be careful of objects being thrown out!
8. Always switch off the machine and pull out the spark boot plug before carrying out any maintenance work.
9. All bystanders must be kept at least 15 m from the machine.
10. Tool continues to run some seconds after switching off motor.
11. Caution: Hot machine parts. Keep your distance.

**Note**

1. Read the directions with due care. Familiarize yourself with the settings and proper operation of the machine.
2. Never allow children or other persons who are not familiar with the operating instructions to use the petrol power scythe. Contact your local governmental agency for information regarding minimum age requirements for operating the petrol power scythe.
3. Never use the machine in direct vicinity of persons, especially children.

**Warning:**

Maintain a safety distance of 15m. If approached, switch off the appliance immediately.  
Always keep in mind that the machine operator or user is responsible for accidents involving other persons and/or their property.

**Preliminary measures**

1. Always wear sturdy, non-slip footwear and long trousers when mowing. Never mow barefoot or in sandals.
2. Check the grounds on which the machine will be used and remove all objects that could be caught up and violently flung out.
3. **Warning:** Petrol is highly flammable! Therefore:
  - Only store petrol in containers designed to hold petroleum-based liquids.
  - Only refuel out in the open and do not smoke during the refueling process.
  - Always refuel before starting the engine. Do not open fuel tank cap and do not refuel when the engine is running or when the scythe is hot.
  - If petrol has overflowed, do not under any circumstances attempt to start the engine. Instead, remove the machine from the affected area. Avoid starting the engine until the petrol fumes have completely evaporated.
  - For safety reasons, the petrol tank and other tank closures must be replaced if they are damaged.
4. Replace defective silencers.
5. Before using the petrol grass trimmer, visually inspect it to ensure that the blade, mounting bolts and the entire cutting apparatus are in good working order (i.e. not worn out or damaged). To prevent any imbalance, replace worn out or damaged blades and mounting bolts as a set only (if applicable).

**Handling**

1. **Wear close fitting, tough work clothing** that will provide protection, such as long slacks or trousers, safety work shoes, heavy duty work gloves, hard hat, a safety face shield, or safety glasses for eye protection and a good grade of ear plugs or other sound barriers for hearing protection.
2. **Store in a safe place.** Open fuel cap slowly to release any pressure which may have formed in fuel tank. To prevent a fire hazard, move at least 10 feet (3 meters) from fueling area before starting.
3. **Turn unit off** before setting it down.
4. **Always hold unit firmly with both hands**, the thumb and fingers encircling the handles.
5. **Keep all screws and fasteners tight.** Never operate your equipment when it is improperly adjusted or not completely and securely assembled.
6. **Keep handles dry**, clean and free of fuel

**GB**

mixture.

7. **Keep cutting head as close to ground as practical.** Avoid hitting small objects with cutting head. When cutting on a slope, stand below stringhead. NEVER cut or trim on a hill or slope, etc. if there is the slightest chance of slipping, sliding or losing firm footing.
8. **Check area you will be trimming for debris** that may be struck or thrown during operation.
9. **Keep all parts of your body and clothing away from cutting head** when starting or running engine. Before starting engine, make sure stringhead will not come in contact with any obstacle.
10. **Stop engine** before examining cutting line.
11. **Store equipment away from possible flammable materials**, such as gas-powered water heaters, clothes dryers, or oil-fired furnaces, portable heaters, etc.
12. **Always keep** the debris shield, cutting head, and engine free of debris build-up.
13. **Operation of equipment** should always be restricted to mature and properly instructed individuals.
14. **IF UNFAMILIAR WITH TRIMMING** techniques, practice the procedures with ENGINE in "OFF" position.
15. **ALWAYS CLEAR WORK** area of debris such as cans, bottles, rocks, etc. Striking objects can cause serious injury to operator or bystanders and also damage equipment. If an object is accidentally hit, immediately TURN ENGINE OFF and examine equipment. Never operate unit with damaged or defective equipment.
16. **ALWAYS TRIM OR CUT AT HIGH ENGINE SPEEDS.** Do not run engine slowly at start or during trimming operations.
17. **DO NOT** use equipment for purposes other than trimming or mowing weeds.
18. **DO NOT** operate unit with other people or animals in the immediate vicinity. Allow a minimum of 50 feet (15 meters) between operator and other people and animals when trimming or mowing. Allow a distance of 100 feet (30 meters) between operator and other people and animals when SCALPING with stringhead cutter.
19. **IF OPERATING UNIT ON A SLOPE**, stand below the cutting attachment. DO NOT OPERATE on a slope or hilly incline if there is the slightest chance of slipping or losing your footing.

**Additional safety instructions**

1. **DO NOT USE ANY OTHER FUEL** than that recommended in your manual. Always follow instructions in the Fuel and Lubrication section of this manual. Never use gasoline unless it is properly mixed with 2-stroke engine lubricant. Permanent damage to engine will result, voiding manufacturer's warranty.
2. **DO NOT SMOKE** while refueling or operating equipment.
3. **DO NOT OPERATE UNIT WITHOUT A EXHAUST** and properly installed muffler shield.
4. **DO NOT TOUCH** or let your hands or body come in contact with the exhaust. Hold unit with thumbs and fingers encircling the handles.
5. **DO NOT OPERATE UNIT IN AWKWARD POSITIONS**, off balance, outstretched arms, or one-handed. Always use two hands when operating unit with thumbs and fingers encircling the handles.
6. **DO NOT RAISE CUTTING HEAD** above knee height while unit is operating. Injury to operator could result.
7. **DO NOT USE UNIT FOR ANY PURPOSES OTHER** than trimming lawn or garden areas.
8. **DO NOT OPERATE UNIT FOR PROLONGED PERIODS.** Rest periodically.
9. **DO NOT OPERATE UNIT WHILE UNDER THE INFLUENCE OF ALCOHOL OR DRUGS.**
10. **DO NOT OPERATE UNIT UNLESS DEBRIS SHIELD AND/OR GUARD IS INSTALLED AND IN GOOD CONDITION.**
11. **DO NOT ADD, REMOVE OR ALTER ANY COMPONENTS OF THIS PRODUCT.** Doing so could cause personal injury and/or damage the unit voiding the manufacturer's warranty.
12. **DO NOT** operate your unit near or around flammable liquids or gases whether in or out of doors. An explosion and/or fire may result.
13. **DO NOT USE ANY OTHER CUTTING TOOLS.** For your own safety only use the accessories and additional equipment specified in the operating manual or recommended or specified by the manufacturer. The use of tools or accessories other than those recommended in the operating manual or catalog may place you in danger of personal injury.

## 2. Machine layout and items supplied (Fig. A-C)

A/1, B/1	Cutting head
A/2	Cutting line
A/3, B/3	Guard hood
A/4, B/4	Long handle with drive shaft
A/5, B/5	Additional handle
A/6	Engine switch "ON/OFF"
A/7	Throttle lever "release"
A/8	Throttle lever
A/9	Throttle lever "lock"
A/10	Choke lever
A/11	Starter cable
A/12	Spark plug boot
A/13	Air filter housing cover
A/14	Petrol tank
A/15	Housing for engine cooler and starter
A/16	Fuel pump "primer"
A/17, B/17	Carrying strap
A/18, B/18	Connecting piece for long handle
C/19	Combined oil/petrol cylinder
C/20	Spark plug wrench
C/21	Allen key (size 4)
C/22	Allen key (size 6)
C/23	Open-ended spanner (8 mm / 10 mm)

### Safety devices

It is imperative that the guard hood is fitted in order to prevent objects being thrown out by the machine. The integrated blade in the guard hood automatically cuts the cutting line to the optimum length.

## 3. Technical data

Engine type:

2-stroke engine, air-cooled, chrome cylinder	
Engine output (max.):	0.75 kW / 1.0 bhp
Displacement:	26 ccm
Idle speed of engine:	3000 +/- 200 rpm
Max. engine speed:	9000 rpm
Max. twin line speed:	10000 rpm
Ignition:	Electronic
Drive:	Centrifugal clutch
Weight (with empty tank):	5.1 kg
Long handle length:	141 cm
Cutting diameter:	40 cm
Cutting line length:	7,8 m
Cutting line diameter:	2.0 mm

Helpline No: UK 0151 649 1500 / IRE 189 094 6244

Tank capacity:	0.5 l
Spark plug:	NGK BPMR7A
Vibration $a_{hw}$ :	4.92 m/s <sup>2</sup>
Sound pressure level, LpA	83.7 dB
Sound power level, LWA	103.8 dB

Sound and vibration were measured in accordance with DIN EN 11806.

## 4. Intended use

The machine is designed for cutting lawns and grassed areas. The operating instructions as supplied by the manufacturer must be kept and referred to in order to ensure that the machine is properly used and maintained. Any use which is not expressly permitted in the manual may result in damage to the machine and place the user in serious danger. Be sure to observe the restrictions in the safety instructions.

Please note that our machines are not designed for commercial, trade or industrial use. Our warranty will be voided if the machine is used in commercial, trade or industrial businesses or for equivalent purposes.

**Important!** Due to the high risk of bodily injury to the user, the petrol grass trimmer must not be used to carry out the following work: to clean dirt and debris off walkways, or to chop up tree or hedge clippings. Moreover, the petrol power scythe may not be used to level out high areas such as molehills. For safety reasons, the petrol power scythe may not be used as a drive unit for other work tools or toolkits of any kind.

## 5. Environmental protection

- Dispose of soiled maintenance material and operating materials at the appropriate collection point.
- Recycle packaging material, metal and plastics.

## 6. Assembly

### 6.1 Assembling the long handle (Fig. D1 – D3)

Slacken the star grip screw (Fig. D1/Item 1) on the connecting piece on the upper long handle (Fig. D1/Item 3). Then press the lever catch (Fig. D1/Item 2) and carefully slide the lower long handle (Fig. D1/Item 4) into the connecting piece on the upper long handle. When doing so, take care to ensure that

**GB**

the drive shafts on the insides of the long handles slide into each other (turn the spool head gently, if required) and that the front lug on the lever catch (Fig. D2/Item 6) locks into the corresponding hole in the lower long handle (Fig. D2/Item 5). Then retighten the star grip screw (Fig. D1/Item 1) (Fig. D3). To dismantle, proceed in reverse order.

### 6.2 Fitting the additional handle (Fig. E1 – E3)

Slacken the wing nut on the fastening screw on the handle (Fig. E1/Item 1). Remove the wing nut, washer (Fig. E1/Item 2) and fastening screw (Fig. E1/Item 3) from the handle. Push the additional handle onto the long handle (Fig. E2). Then screw the handle to the long handle (Fig. E3).

### 6.3 Fitting the guard hood (Fig. F1 – F3)

Slacken the fastening screw on the guard hood (Fig. F1/Item 1) with the help of the Allen key provided and then remove (Fig. F1). Then attach the guard hood to the lower long handle (Fig. F2). Screw the guard hood tightly in position with the fastening screw (Fig. F3).

### 6.4 Fitting the carrying strap (Fig. G)

The carrying strap is intended to help you work safely and ergonomically with the petrol grass trimmer. Hook the carrying strap into the fastening eyelet (Fig. G/ Item A).

**Check that all moving parts move smoothly before you start using the machine. Check that all screws are securely fastened and also check all the safety devices.**

## 7. Before starting the machine

### 7.1 Setting the cutting height

- Slip the shoulder strap (Fig. A/17) over the left shoulder.
- Set the length of the shoulder strap in such a way that the cutting head or the cutting blade runs parallel to the ground. In order to establish the optimum length of the shoulder strap, you should then make a few swinging movements without starting the engine (Fig. I).

**Warning:** Always use the shoulder strap when using the appliance. Attach the strap as soon as you have started the engine and the engine is running in idle mode. Switch off the engine before you take off the shoulder strap.

### Check the machine for the following each time before use:

- That there are no leaks in the fuel system
- That the cutting unit and all safety devices are in perfect condition
- That all screws are securely fastened

### 7.2 Fuel and oil

#### Recommended fuels

Use only a mixture of normal unleaded petrol and special 2-stroke engine oil. Mix the fuel mixture as indicated on the fuel mixing table.

- Start the machine at least 3 m away from the refueling site to avoid the possible risk of fire.
- Do not smoke whilst refueling or working with the machine.
- Do not use the hedge trimmer near inflammable liquids or gases. This could result in an explosion and/or fire.

**Important:** Do not use a fuel mixture which has been kept for longer than 90 days.

**Important:** Do not use 2-stroke oil with a recommended mixing ration of 100:1. If inadequate lubrication causes engine damage, the manufacturer's engine warranty will be voided.

**Important:** Only use containers designed and approved for the purpose to transport and store fuel.

Pour the correct quantities of petrol and 2-stroke oil into the mixing bottle (see scale printed on the bottle). Then shake the bottle well.

### 7.3 Fuel mixture table

Petrol (unleaded)	2-stroke oil
1 liter	25 ml
5 liters	125 ml

Mixing procedure: 40 parts petrol to 1 part oil

## 8. Operation

Please note that the statutory regulations governing noise abatement may differ from town to town.

**Important.** A blade (Fig. L/ Item 1) on the underside of the guard hood automatically cuts the cutting line to the optimum length. This is covered by a guard. Remove the guard before you start working (Fig. L/ Item 2) and replace it when you have finished working.

**8.1 Starting the engine when cold**

Fill the tank with the required amount of oil/petrol mix. See "Fuel and oil".

1. Set the machine down on a hard, level surface.
2. Set the choke lever (Fig. A/Item 10) to "I" position.
3. Press the fuel pump (primer) (Fig. H) 10 times.
4. Switch the ON/OFF switch (Fig. A/Item 6) to "I".
5. Secure the throttle lever. To do so, actuate the throttle lock (Fig. A/Item 7) and then actuate the throttle lever (Fig. A/Item 8) while pressing the locking button (Fig. A/Item 9) at the same time to secure the throttle lever.
6. Hold the machine firmly and pull out the starter cable (Fig. A/Item 11) until you feel it start to resist. Then tug sharply on the starter cable 4 times. The machine should start.

**Important:** Never allow the starter cable to snap back. This may damage the machine.

7. Once the engine has started, move the choke lever immediately to "I" and allow the machine to warm up for approx. 10 seconds.

**Important:** Since the throttle lever is secured, the cutting tool starts to operate when the engine is started.

Then release the throttle lever by simply actuating it (the engine then returns to running in idle mode).

8. If the engine does not start up, repeat steps 6-7 above.

**Please note:** If the engine does not start up even after several attempts, read the section "Troubleshooting".

**Please note:** Always pull the starter cable out in a straight line. If it is pulled out at an angle, then friction will occur on the eyelet. As a result of this friction, the cable will become frayed and will wear away faster. Always hold the starter handle when the cable retracts. Never allow the cable to snap back when it has been pulled out. This may also cause damage to the cable or the starter.

**8.2 Starting the engine when warm (if the machine has not been switched off for more than 15 – 20 minutes)**

1. Set the machine down on a hard, level surface.
2. Switch the ON/OFF switch to "I".
3. Secure the throttle lever (in the same way as described in "Starting the engine when cold").
4. Hold the machine firmly and pull out the starter cable until you feel it start to resist. Then tug sharply on the starter cable. The machine should start after 1-2 tugs. If the machine still fails to start after 6 tugs, repeat steps 1 – 7 for starting the engine when cold.

**8.3 Switching off the engine**

Emergency Stop procedure:

If it becomes necessary to stop the machine immediately, set the ON/OFF switch to "Stop" or "0".

Normal procedure:

Let go of the throttle lever and wait until the engine has changed to idling speed. Then set the ON/OFF switch to "Stop" or "0".

**8.4 Practical tips**

**Practice all operating techniques with the engine switched off before you start to use the machine.**

**STRINGHEAD LINE RELEASE**

**⚠ WARNING:** DO NOT use steel wire or plastic-coated steel wire of any kind with your stringhead. Serious operator injury can result.

To release fresh line, run engine at full throttle and "bump" cutting head against lawn. Line will automatically release. The knife in debris shield will trim excess line (Fig. M1).

**⚠ CAUTION:** Periodically remove weed wrap to prevent overheating the drive shaft. Weed wrap occurs when strands of weed become entangled around the shaft beneath the debris shield (Fig. M2). This condition prevents the shaft from being properly cooled. Remove weed wrap with screwdriver or similar

**TRIMMING PROCEDURES**

When properly equipped with a debris shield and cutting head, your unit will trim unsightly weeds and tall grass in those hard-to-reach areas - along fences, walls, foundations and around trees. It can also be used for scalping to remove vegetation down to the ground for easier preparation of a garden or to clean out a particular area.

**⚠ NOTE:** Even with care, trimming around foundations, brick or stone walls, curves, etc., will result in above normal string wear.

**TRIMMING / MOWING**

Swing trimmer with a sickle-like motion from side to side. Do not tilt the cutting head during the procedure. Test area to be trimmed for proper cutting height. Keep stringhead at same level for even depth of cut (Fig. M3).

**GB****CLOSER TRIMMING**

Position trimmer straight ahead with a slight tilt so bottom of stringhead is above ground level and string contact occurs at proper cutting point. Always cut away from operator. Do not pull trimmer in toward operator.

**FENCE / FOUNDATION TRIMMING**

Approach trimming around chain link fences, picket fences, rock walls and foundations slowly to cut close without whipping string against the barrier. If the string comes in contact with rock, brick walls, or foundations, it will break or fray. If string snags fencing, it will snap off.

**TRIMMING AROUND TREES**

Trim around tree trunks with a slow approach so string does not contact bark. Walk around the tree trimming from left to right. Approach grass or weeds with the tip of the string and tilt cutting head slightly forward.

**⚠ WARNING:** Use extreme caution when SCALPING. Keep a distance of 100 feet (30 meters) between operator, other people and animals during these operations.

**SCALPING**

Scalping refers to removal of all vegetation down to the ground. To do this, tilt the cutting head to about a 30 degree angle to the left. By adjusting the handle you will have better control during this operation. Do not attempt this procedure if there is any chance flying debris could injure operator, other people or cause damage to property. (Fig. M4)

**9. Maintenance**

Always switch off the machine and pull out the spark boot plug before carrying out any maintenance work.

**9.1 Replacing the line spool / cutting line**

1. Unscrew the retainer screw (Fig. N1/Item A) in a counter-clockwise direction and remove (Fig. N1/N2).
2. Remove the spool (Fig. N3/Item B) and the spring (Fig. N3/Item C) from the spindle (Fig. N3/Item D).

The following steps only have to be carried out if only the line and not the entire spindle requires replacing:

- Remove the remaining cutting line from the spool.

- Hold the two halves of a new cutting line together in the middle and place the loop in one of the slots on the spool divider (Fig. N4).
  - Wind the line with tension in a counter-clockwise direction as shown in the illustration (Fig. N5), with the two halves being separated by the spool divider. Wind up all of the line down to the last 15 cm of each end.
3. Fasten each of the ends of the line in a slot (Fig. N6/Item F) on the opposite side of the spool.
  4. Fit the springs on the inside of the spool and thread each of the ends of the line through one of the eyelets in the spool holder (Fig. N3/Item E).
  5. Insert the spool in the spool holder. Make sure that the spring slides over the spindle and does not get stuck.
  6. Press the spool into the spool holder with your hand and use your other hand to fasten the retainer screw tightly (Fig. N7).
  7. Give each end of the line a strong tug to pull the line out of the slots.
  8. Cut off all excess line to reduce it to approx. 13 cm. This will reduce the load on the engine when starting up and warming up.

**9.2 Maintenance of the air filter (Fig. J1-J3)**

Soiled air filters reduce the engine output by supply too little air to the carburetor.

Regular checks are therefore essential. The air filter should be checked after every 25 hours of use and cleaned if necessary. If the air contains a lot of dust, the air filter should be checked more frequently.

1. Remove the air filter cover (Fig. J1-J2)
2. Remove the filter element (Fig. J3)
3. Clean the filter element by tapping it or blowing it.
4. Assemble in reverse order.

**Important:** Never clean the air filter with petrol or inflammable solvents. Clean the air filter with compressed air or by tapping it.

**9.3 Maintenance of the spark plug (Fig. K1-K2)**

Spark plug gap = 0.025 inch (0.635 mm). Tighten the spark plug with a torque of 12-15 Nm.

Check the spark plug for dirt and grime after 10 hours of operation and if necessary clean it with a copper wire brush. Thereafter service the spark plug after every 50 hours of operation.

1. Pull off the spark plug boot (Fig. K1) by twisting.
2. Remove the spark plug (Fig. K2) with the supplied spark plug wrench.
3. Assemble in reverse order.

#### 9.4 Grinding the safety hood blade

The safety hood blade (Fig. L/Item 1) can become blunt over time. When you notice this, undo the two screws holding the safety hood blade to the safety hood. Clamp the blade in a vise. Sharpen the blade with a flat file and make sure that the angle of the cutting edge is not altered in the process. File in one direction only.

#### 9.5 Carburetor settings

**Important.** Settings on the carburetor may only be made by authorized customer service personnel. The air filter cover must be removed before any work on the carburetor, as shown in Figures J1 – J2.

#### Setting the throttle cable

If the maximum speed of the machine falls over time and you have ruled out all the other causes listed in section 13 Troubleshooting, it may be necessary to adjust the throttle cable.

First of all check whether the carburetor opens fully when the throttle handle is pressed fully. This is the case if the carburetor slide (Fig. O1/Item 1) rests against the stop (Fig. O1/Item 2) when the throttle is fully open. Figure O1 shows the correct setting. If the carburetor slide does not touch the stop, it must be adjusted.

The following work is required to adjust the throttle cable:

- Undo the lock nut (Fig. O2/Item 3) a few turns.
- Undo the adjusting screw (Fig. O3/Item 4) until the carburetor slide rests against the stop when the throttle is fully open, as shown in Figure O1.
- Retighten the lock nut.

#### Setting the idling speed

**Important.** Set the idling speed when the machine is warm.

If the engine stalls when the throttle is not pressed and you have ruled out all the other causes listed in section 13 Troubleshooting, the idling speed must be adjusted. To do this turn the idling speed screw (Fig. O4/Item 5) clockwise until the machine runs smoothly at idling speed.

If the idling speed is so fast that the cutting tool turns as well, it has to be reduced by turning the idling speed screw (Fig. O4/Item 5) for as long as is required for the cutting tool to stop turning as well.

## 10.Storage

**Important:** If you fail to follow these instructions correctly, deposits may form on the interior of the carburetor which may result in the engine being more difficult to start or the machine suffering permanent damage.

1. Carry out all the maintenance work.
2. Drain the fuel out of the tank (use a conventional plastic petrol pump from a DIY store for this purpose).
3. When the fuel has been drained, start the engine.
4. Allow the engine to run at idling speed until it stops. This will clean the remainder of the fuel out of the carburetor.
5. Leave the machine to cool (approx. 5 minutes).
6. Remove the spark plug (see point 9.3).
7. Place a teaspoon full of 2-stroke engine oil into the combustion chamber. Pull the starter cable several times carefully to wet the internal components with the oil. Fit the spark plug again.
8. Clean the exterior housing of the machine.
9. Store the machine in a cold, dry place where it is out of the reach of ignition sources and inflammable substances.

Fertilizers and other chemical garden products often contain substances that accelerate the rate of corrosion of metals. Do not store the machine on or near fertilizers or other chemicals.

#### Restarting

1. Remove the spark plug.
2. Pull the starter cable several times to clean the oil residue out of the combustion chamber.
3. Clean the spark plug contacts or fit a new spark plug.
4. Fill the tank. See the section entitled Fuel and oil.
5. Complete steps 1-7 described under the point entitled "Starting the engine from cold".

#### Transport

To transport the machine, first empty the petrol tank as described in section 3 in the Chapter "Storage". Clean coarse dirt off the machine with a brush or hand brush. Dismantle the long handle as described 5.1.

**GB**

## 11. Disposal

### Important.

The petrol grass trimmer is made of several different materials such as metal, liquids and plastics. Take any defective components and fluids that are no longer in use to special waste disposal points. Ask your dealer or your local council.

## 12. Ordering replacement parts

Please quote the following data when ordering replacement parts:

- Type of machine
- Article number of the machine
- Identification number of the machine
- Replacement part number of the part required

### Helpline Numbers:

UK: 0151 649 1500

IRE: 189 094 6244



**13. Troubleshooting**

<b>Fault</b>	<b>Possible cause</b>	<b>Troubleshooting</b>
The machine does not start.	Correct starting procedure not followed.	Follow the instructions for starting.
	Sooted or damp spark plug	Clean the spark plug or replace it with a new one.
	Incorrect carburetor setting	Contact an authorized customer service outlet
The machine starts but does not develop its full output.	Incorrect choke lever setting	Set choke lever to "I+I".
	Soiled air filter	Clean the air filter
	Incorrect carburetor setting	Contact an authorized customer service outlet
The engine does not run smoothly	Incorrect electrode gap on the spark plug	Clean the spark plug and adjust the electrode gap or fit a new spark plug.
	Incorrect carburetor setting	Contact an authorized customer service outlet
Engine smokes excessively	Incorrect fuel mix	Use the correct fuel mix (see fuel mixing table)
	Incorrect carburetor setting	Contact an authorized customer service outlet

# Petrol Engine Starting Procedure / Check List

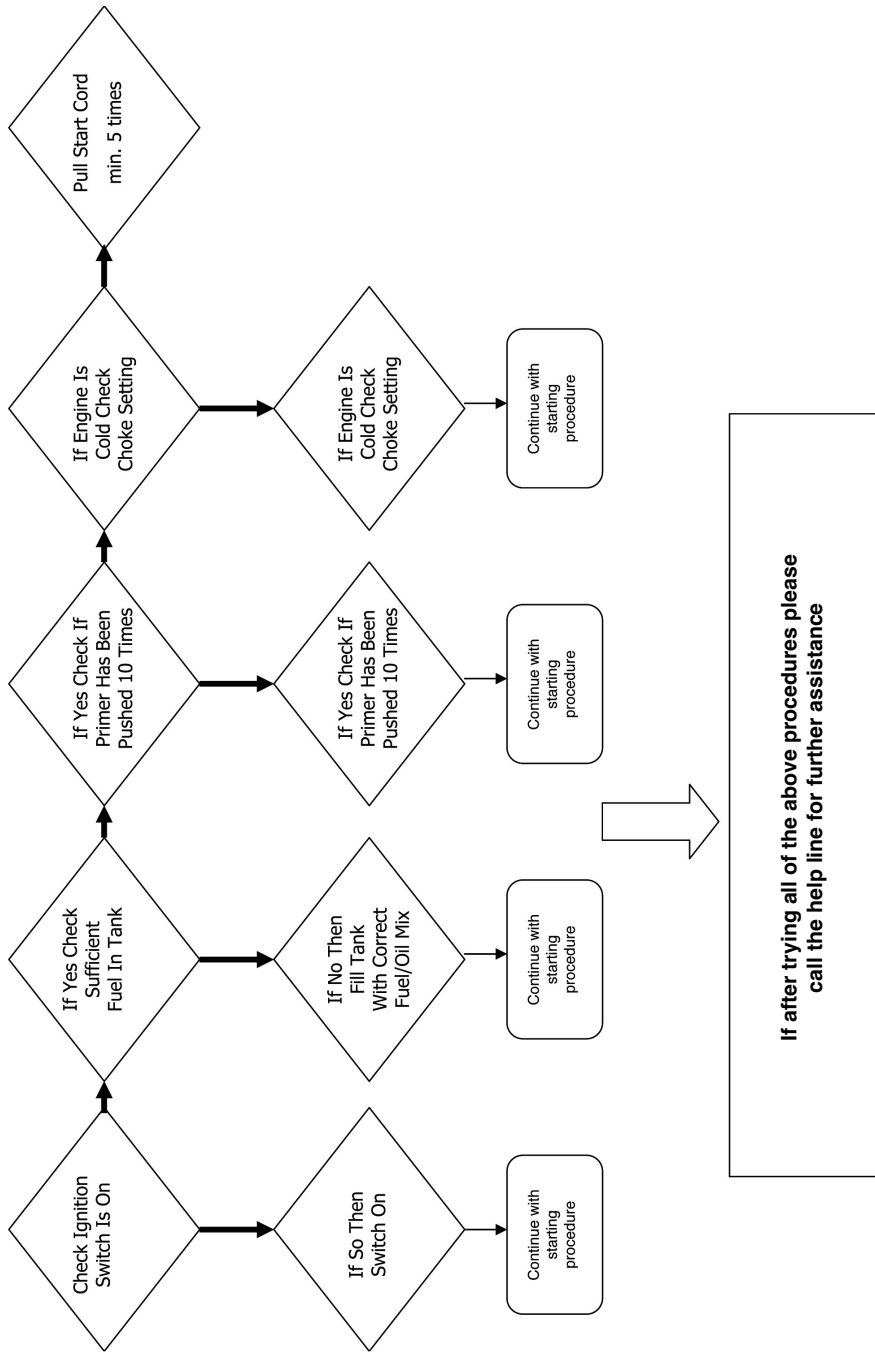

If after trying all of the above procedures please call the help line for further assistance

ISC GmbH  
Eschenstraße 6  
D-94405 Landau/Isar

## Konformitätserklärung



- D** erklärt folgende Konformität gemäß EU-Richtlinie und Normen für Artikel
- GB** declares conformity with the EU Directive and standards marked below for the article
- F** déclare la conformité suivante selon la directive CE et les normes concernant l'article
- NL** verklaart de volgende conformiteit in overeenstemming met de EU-richtlijn en normen voor het artikel
- E** declara la siguiente conformidad a tenor de la directiva y normas de la UE para el artículo
- P** declara a seguinte conformidade de acordo com a directiva CE e normas para o artigo
- S** förklarar följande överensstämmelse enl. EU-direktiv och standarder för artikeln
- FIN** ilmoittaa seuraavaa Euroopan unionin direktiivien ja normien mukaista yhdenmukaisuutta tuotteelle
- N** erklærer herved følgende samsvar med EU-direktiv og standarder for artikkel
- BG** заявяет о соответствии товара следующим директивам и нормам EC
- HR** izjavljuje sljedeću uskladenost s odredbama i normama EU za artikl.
- RO** declară următoarea conformitate cu linia directoare CE și normele valabile pentru articolul.
- TR** ürün ile ilgili olarak AB Yönetmeliğindeki ve Normları gereğince aşağıdaki uygunluk açıklama masını sunar.
- GR** δηλώνει την ακόλουθη συμφωνία σύμφωνα με την Οδηγία ΕΕ και τα πρότυπα για το προϊόν

- I** dichiara la seguente conformità secondo la direttiva UE e le norme per l'articolo
- GB** attesterer følgende overensstemmelse i henhold til EU-direktiv og standarder for produkt
- CZ** prohlašuje následující shodu podle směrnice EU a norem pro výrobek.
- H** a következő konformitást jelenti ki a termékek-re vonatkozó EU-irányvonalak és normák szerint
- SU** pojasnjuje sledečo skladnost po smernici EU in normah za artikel.
- PL** deklaruje zgodność wymienionego poniżej artykułu z następującymi normami na podstawie dyrektywy WE.
- SK** vydáva nasledujúce prehlásenie o zhode podľa smernice EÚ a noriem pre výrobok.
- BG** декларира следното съответствие съгласно директивите и нормите на ЕС за продукта.
- UKR** заявляє про відповідність згідно з Директивою ЄС та стандартами, чинними для даного товару
- EE** deklareerib vastavuse järgnevatele EL direktiivi dele ja normidele
- LT** deklaruoja atitiktį pagal ES direktyvas ir normas straipsniui
- CS** izjavljuje sledeći konformitet u skladu s odred bom EZ i normama za artikl
- LV** Atbilstības sertifikāts apliecina zemāk minēto preču atbilstību ES direktīvām un standartiem
- IS** Samræmisýfirlýsing staðfestir eftirfarandi samræmi samkvæmt reglum Evrópubandalagsins og stöðlum fyrir vörur

### Petrol Motor Trimmer SPJGT 26

- |  |   |
|--|---|
| <input checked="" type="checkbox"/> 98/37/EG             | <input type="checkbox"/> 87/404/EWG   |
| <input type="checkbox"/> 73/23/EWG_93/68/EEC             | <input type="checkbox"/> R&TTED 1999/5/EG   |
| <input type="checkbox"/> 97/23/EG                        | <input checked="" type="checkbox"/> 2000/14/EG: L <sub>WM</sub> = 103 dB; L <sub>WA</sub> = 105 dB<br>P = 0,75 kW Ø 40 cm |
| <input checked="" type="checkbox"/> 89/336/EWG_93/68/EEC | <input type="checkbox"/> 95/54/EG:  |
| <input type="checkbox"/> 90/396/EWG                      | <input checked="" type="checkbox"/> 97/68/EG: e13*97/68SH2G3*2002/88*0227*00  |
| <input type="checkbox"/> 89/686/EWG                      |   |

EN ISO 11806; EN ISO 14982; KBV V

Landau/Isar, den 06.09.2006

Wejchse/gartner  
General-Manager

Wimmer  
Product-Management

Art.-Nr.: 34.017.21 I.-Nr.: 01016  
Subject to change without notice

Archivierung: 3401720-22-4155050

## GUARANTEE CERTIFICATE

**Dear Customer,**

All of our products undergo strict quality checks to ensure that they reach you in perfect condition. In the unlikely event that your device develops a fault, please contact our service department at the address shown on this guarantee card. Of course, if you would prefer to call us then we are also happy to offer our assistance under the service number printed below. Please note the following terms under which guarantee claims can be made:

1. These guarantee terms cover additional guarantee rights and do not affect your statutory warranty rights. We do not charge you for this guarantee.
2. Our guarantee only covers problems caused by material or manufacturing defects, and it is restricted to the rectification of these defects or replacement of the device. Please note that our devices have not been designed for use in commercial, trade or industrial applications. Consequently, the guarantee is invalidated if the equipment is used in commercial, trade or industrial applications or for other equivalent activities. The following are also excluded from our guarantee: compensation for transport damage, damage caused by failure to comply with the installation/assembly instructions or damage caused by unprofessional installation, failure to comply with the operating instructions (e.g. connection to the wrong mains voltage or current type), misuse or inappropriate use (such as overloading of the device or use of non-approved tools or accessories), failure to comply with the maintenance and safety regulations, ingress of foreign bodies into the device (e.g. sand, stones or dust), effects of force or external influences (e.g. damage caused by the device being dropped) and normal wear resulting from proper operation of the device.

The guarantee is rendered null and void if any attempt is made to tamper with the device.

3. The guarantee is valid for a period of 2 years starting from the purchase date of the device. Guarantee claims should be submitted before the end of the guarantee period within two weeks of the defect being noticed. No guarantee claims will be accepted after the end of the guarantee period. The original guarantee period remains applicable to the device even if repairs are carried out or parts are replaced. In such cases, the work performed or parts fitted will not result in an extension of the guarantee period, and no new guarantee will become active for the work performed or parts fitted. This also applies when an on-site service is used.

Of course, we are also happy offer a chargeable repair service for any defects which are not covered by the scope of this guarantee or for units which are no longer covered. To take advantage of this service, please send the device to our service address.

Argos Ltd  
489-499 Avebury Boulevard  
Saxon Gate West  
Central Milton Keynes  
**MK9 2NW**

**Helpline Numbers:**

**UK: 0151 649 1500**

**IRE: 189 094 6244**

© Technical specifications subject to change





©

The reprinting or reproduction by any other means, in whole or in part, of documentation and papers accompanying products is permitted only with the express consent of ISC GmbH.

Einhell UK Ltd  
Unit 5 Morpeth Wharf  
Twelve Quays  
Birkenhead, Wirral  
**CH41 1LF**  
Tel. 0151 6491500, Fax 0151 6491501

EH 10/2006

**Helpline No: UK 0151 649 1500 / IRE 189 094 6244**