



36V BRUSHLESS 2X18V

LAWN MOWER

INSTRUCTION MANUAL

SPECIFICATIONS

Input:	2 x 18V
Cutting Diameter:	380mm
Cutting Heights:	25 - 75mm, 6 position
No Load Speed:	3,400/min
Grass Catcher:	45 litres
Noise Rating:	96dB
Tool Weight:	15.5kg

ozito.com.au

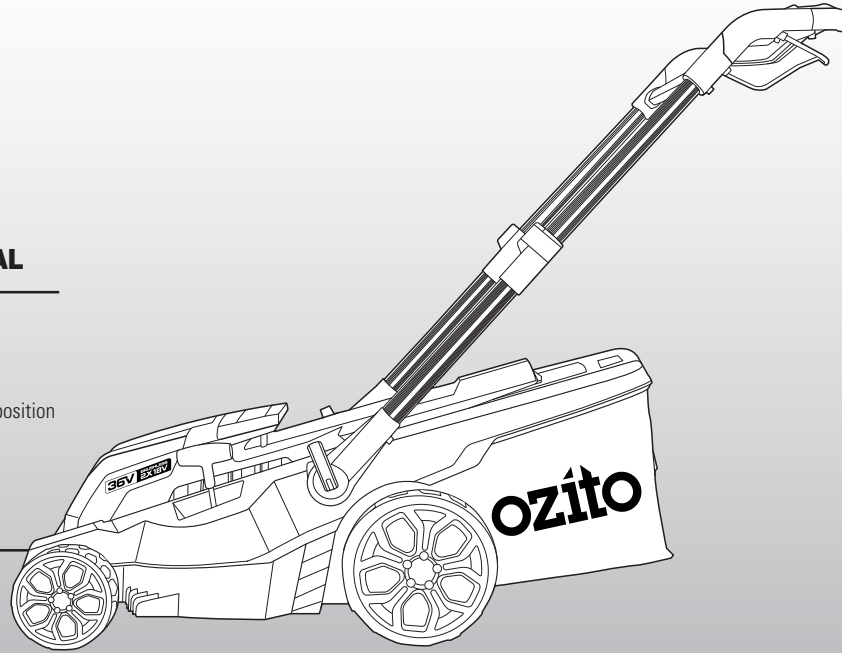

5 YEAR
REPLACEMENT WARRANTY

STANDARD EQUIPMENT

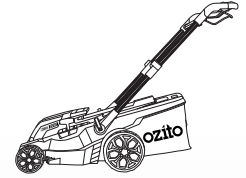

Brushless Lawn Mower

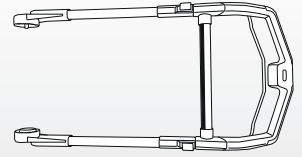

Telescopic Handle

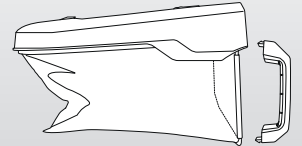

Grass Catcher & Handle

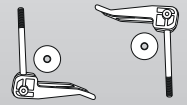

Quick-release Handle Set

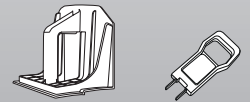

Mulching Plug, Safety Key

PXBTMS-3638

WARRANTY

IN ORDER TO MAKE A CLAIM UNDER THIS WARRANTY YOU MUST RETURN THE PRODUCT TO YOUR NEAREST BUNNINGS WAREHOUSE WITH YOUR BUNNINGS REGISTER RECEIPT. PRIOR TO RETURNING YOUR PRODUCT FOR WARRANTY PLEASE TELEPHONE OUR CUSTOMER SERVICE HELPLINE:

Australia 1800 069 486

New Zealand 0508 069 486

TO ENSURE A SPEEDY RESPONSE PLEASE HAVE THE MODEL NUMBER AND DATE OF PURCHASE AVAILABLE. A CUSTOMER SERVICE REPRESENTATIVE WILL TAKE YOUR CALL AND ANSWER ANY QUESTIONS YOU MAY HAVE RELATING TO THE WARRANTY POLICY OR PROCEDURE.

WARNING

The following actions will result in the warranty being void.

- If the tool has been operated on a supply voltage other than that specified on the tool.
- If the tool shows signs of damage or defects caused by or resulting from abuse, accidents or alterations.
- Failure to perform maintenance as set out within the instruction manual.
- If the tool is disassembled or tampered with in any way.
- Professional, industrial or high frequency use.

The benefits provided under this warranty are in addition to other rights and remedies which are available to you at law.

Our goods come with guarantees that cannot be excluded at law. You are entitled to a replacement or refund for a major failure and for compensation for any other reasonably foreseeable loss or damage. You are also entitled to have the goods repaired or replaced if the goods fail to be of acceptable quality and the failure does not amount to a major failure.

Generally you will be responsible for all costs associated with a claim under this warranty, however, where you have suffered any additional direct loss as a result of a defective product you may be able to claim such expenses by contacting our customer service helpline above.

5 YEAR REPLACEMENT WARRANTY

Your Product is guaranteed for a period of 60 months from the original date of purchase and is intended for DIY (Do It Yourself) use only. If a product is defective it will be replaced in accordance with the terms of this warranty. **Lithium Ion batteries and chargers are covered by a 36 month warranty.** Warranty excludes consumable parts, for example: wheels, blade, cord clips, bearings etc.

KNOW YOUR PRODUCT

BRUSHLESS LAWN MOWER

- | | |
|----------------------------|--|
| 1. Wheels | 7. Start/Stop Lever |
| 2. Battery Cover | 8. Lock-Off Button |
| 3. Height Adjustment Lever | 9. Telescopic Handle Quick-release Lever |
| 4. Carry Handle | 10. Grass Catcher |
| 5. Telescopic Handle | 11. Handle Angle Quick-release Lever |
| 6. Grass Catcher Flap | 12. Cutting Deck |

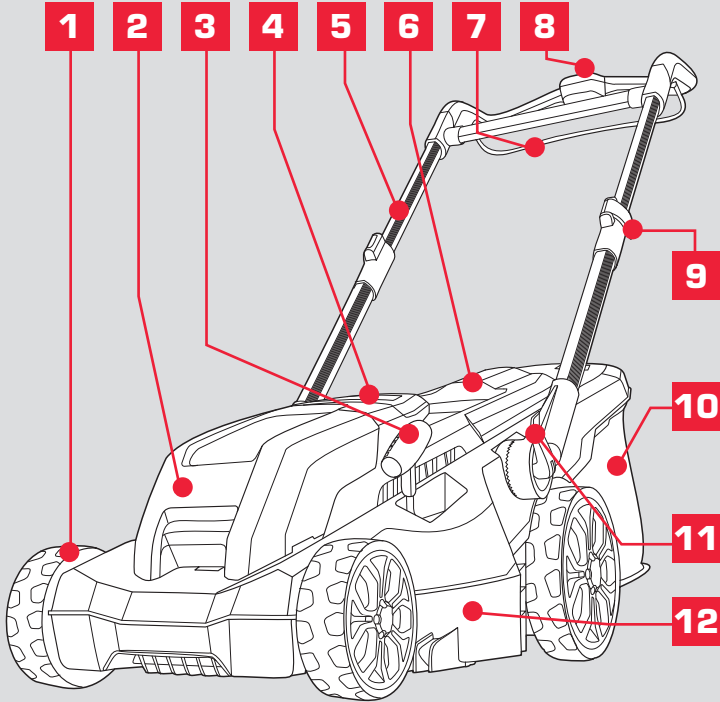

ACCESSORIES

- | | |
|----------------|-------------------|
| 13. Safety Key | 14. Mulching Plug |
|----------------|-------------------|

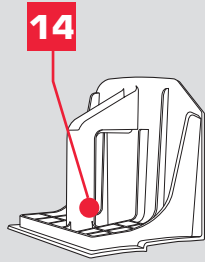
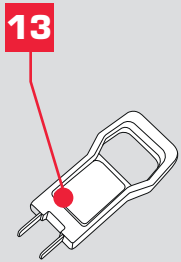

BATTERY & CHARGER

This tool is compatible with all batteries and chargers from the Ozito PXC Range.

ONLINE MANUAL

Scan this QR Code with your mobile device to take you to the online manual.



5 YEAR
REPLACEMENT WARRANTY

SETUP & PREPARATION

1. ASSEMBLY



WARNING! ENSURE THE LAWN MOWER IS SWITCHED OFF AND THE BATTERIES ARE DISCONNECTED BEFORE PERFORMING ANY OF THE FOLLOWING TASKS.

Fitting the Telescopic Handle

- Place the telescopic handle assembly over the teeth of the mower handle brackets.

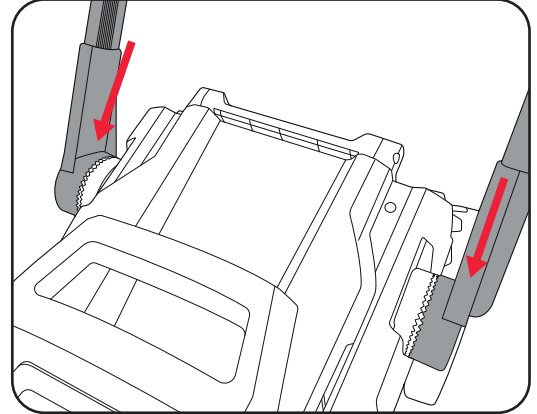

- While supporting the handle secure with washer and Handle Angle Quick-release Lever on both sides, with three settings available for the angle.

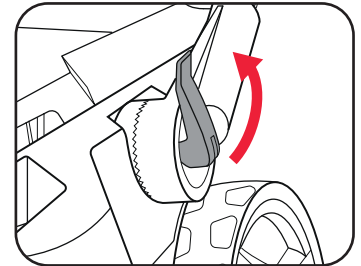
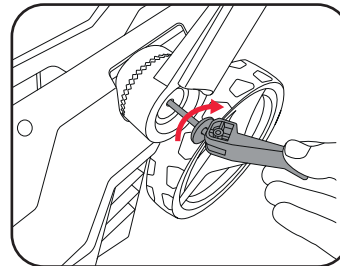

Note: If necessary, turn the quick-release lever back sufficiently on the thread so that the handle quick-release lever can then still be flipped upwards.

- Ensure one of the three positions available is selected to the Height Adjustment Line OTHERWISE THIS WILL PREVENT THE MOWER FROM OPERATING. As you make your selection, make sure that both sides are set to the same position.

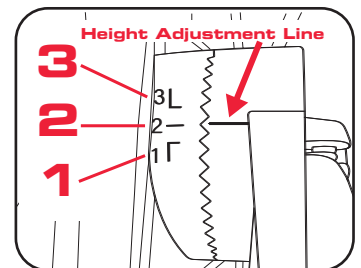

Grass Catcher Handle Assembly

- The handle will click into position when aligned and fitted correctly.

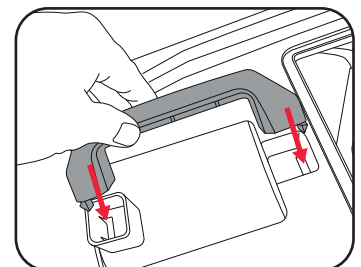

5 YEAR
REPLACEMENT WARRANTY

Fitting and Removing the Grass Catcher

WARNING! ONLY FIT AND REMOVE THE GRASS CATCHER WHEN THE MOWER IS SWITCHED OFF AND THE MOTOR HAS COME TO A STOP.

1. Lift up the grass catcher flap with one hand and guide the catcher with your other hand over the two hooks on the mower housing.
2. Lower the grass catcher and allow it to sit in place. Lower the grass catcher flap.

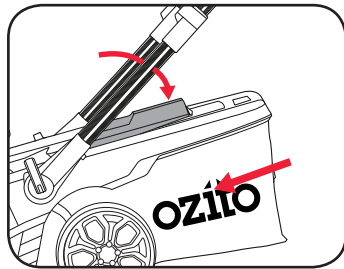
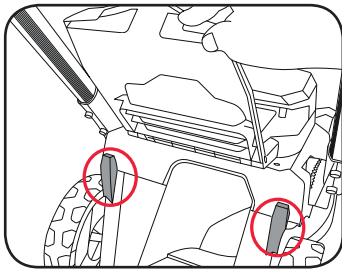

Note: The grass catcher flap is held against the grass catcher by a spring.

3. To remove, raise the grass catcher flap and lift the grass catcher out.

WARNING! WHEN FITTING THE GRASS CATCHER AFTER EMPTYING, ALWAYS ENSURE THERE IS NO BUILD UP OF GRASS IN THE EJECTOR OPENING.

Grass Catcher Indicator

The grass catcher is fitted with an indicator at the rear of the catcher to help identify when to empty.

If the indicator drops down while operating then the grass catcher is full and needs emptying.

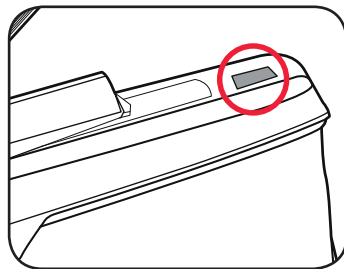

Mulching Plug

With the mulching plug fitted the cuttings are shredded in the enclosed mower housing and then spread back onto the lawn.

1. To use the mulching plug, remove the grass catcher, slide the mulching plug through the ejector opening and close the grass catcher flap.

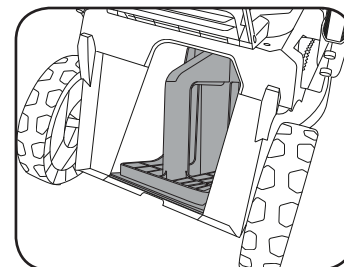
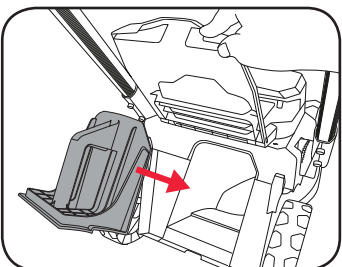

Note: Mulching is only possible if the lawn is relatively short.

2. PREPARATION

Adjusting the Telescopic Handle

1. To adjust the height of the handle flip up the two quick-release levers.
2. Adjust the handle into the desired height. To lock in place flip the two quick-release levers back into the closed position.

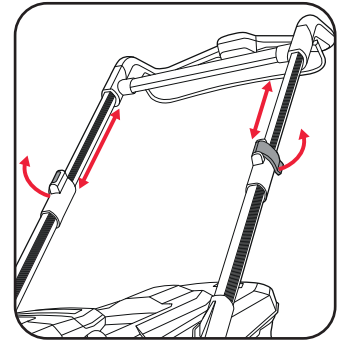

3. To adjust the angle of the handle flip up the two handle angle quick-release levers. Three setting positions available for the angle. **Ensure one of the three setting positions available is selected otherwise the mower will not operate.**

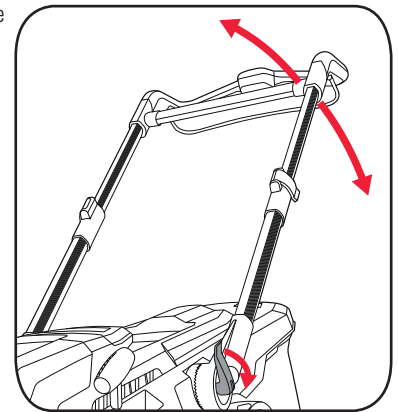

Note: Ensure that both sides are set to the same position.

4. To lock in place flip the two handle angle quick-release levers back into the closed position.

Adjusting the Cutting Height

WARNING! ENSURE THE TOOL IS SWITCHED OFF AND BATTERIES ARE DISCONNECTED BEFORE PERFORMING ANY OF THE FOLLOWING TASKS.

The cutting height can be set between 25mm - 75mm in 6 intervals and can be read off the scale.

1. Pull lever outwards away from the mower body.
2. Adjust until the required cutting height is selected.
3. Release lever and check that it is securely seated in the required cutting height position.

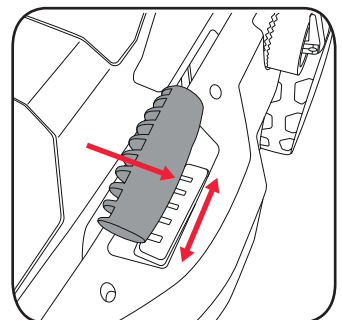

OPERATION

Inserting the Batteries & Safety Key

Only use 2 batteries with the same capacity. For best performance use 3.0Ah batteries and above. Always use 2 batteries with the same charge state with the mower.

1. Open the battery cover. Slide two batteries of the same capacity and same charge state into the mower aligning the ribs so that they click into place.

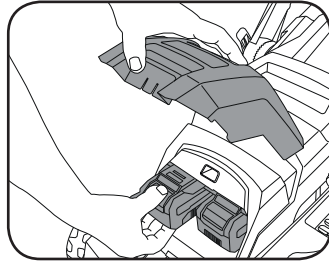

2. Insert the safety key. (If the mower is not going to be used immediately, do not insert the safety key.)

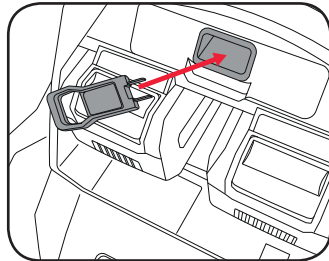

3. Close the battery cover.

WARNING! ALWAYS ENSURE THE SAFETY KEY AND BATTERIES ARE REMOVED WHEN NOT IN USE.

Removing the Batteries from the Mower

1. Open the battery cover. Press the battery release tab and remove the battery.
2. Close the battery cover.

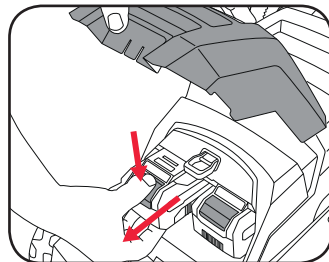

Run Time

The operating time of the PXC battery (the area in square meters that can be covered with a single battery charge) is largely dependent on the state of the grass (e.g. Density, moisture, height, etc.) the lawn mower cutting height position and your walking speed.

Frequently turning the equipment on and off while mowing will also reduce the amount of area that you can cover. If the operating time of the PXC battery (area coverage) is still unsatisfactory in spite of the above measures, you can remedy the problem by using PXC battery with a larger capacity (Ah).

3. MOWING

WARNING! ALWAYS WEAR STURDY, NON-SLIP FOOTWEAR, LONG TROUSERS, SAFETY GLASSES AND HEARING PROTECTION WHEN USING THE EQUIPMENT. NEVER USE THE EQUIPMENT BAREFOOT OR IN SANDALS.

Switching On and Off

To prevent accidental start up, the mower is fitted with a dual action switch.

1. Press and hold the lock-off button.
2. Pull the start/stop lever towards the handle to start the mower and then release the lock-off button.

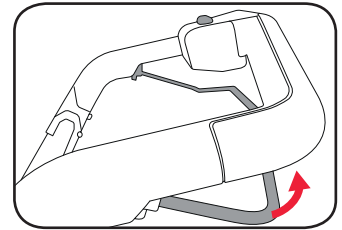
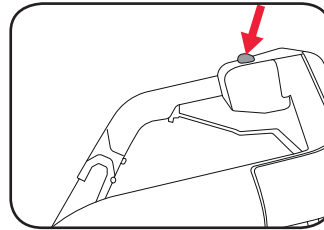

3. Release the start/stop lever to stop the mower.

WARNING! THE MOWER BLADE WILL STOP A FEW SECONDS AFTER THE START/STOP LEVER HAS BEEN RELEASED. BE AWARE OF THE NECESSARY TIME IT TAKES FOR THE BLADE TO STOP. DO NOT ATTEMPT TO STOP THE BLADE.

Lawn Mowing Tips

Start mowing the edge of the lawn and work along making sure to overlap each pass by a few centimetres.

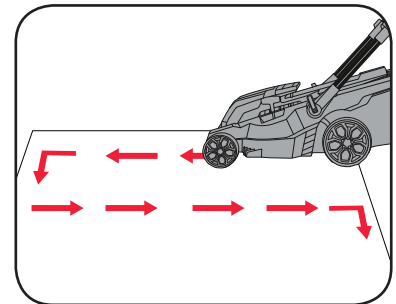

When mowing long grass be sure to not overload the motor. First cut with the highest cutting height and then to the desired height. This will help reduce the load.

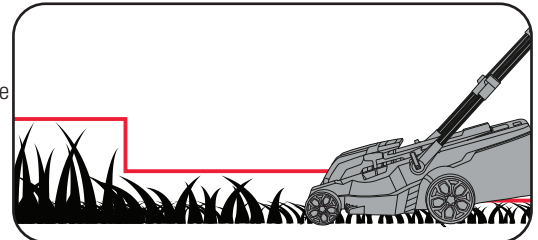

- Make sure the lawn is clear of sticks, stones, wire and debris; they could be thrown by the blade.
- Before using the lawn mower and after any impact, check for signs of wear or damage and repair as necessary.
- For optimum grass collection, always mow in a straight line; do not swing the lawn mower from side to side.
- Replace a worn or damaged blade together with the blade bolt to preserve balance.

WARNING! DO NOT MOW WITH POOR VISIBILITY CONDITIONS, IN THE RAIN OR WHEN GRASS IS WET.

MAINTENANCE



WARNING! ALWAYS ENSURE THE LAWN MOWER BLADE HAS COMPLETELY STOPPED, REMOVE SAFETY KEY, BATTERIES AND GRASS CATCHER PRIOR TO ANY MAINTENANCE.

Removing and Fitting the Blade



WARNING! ALWAYS USE GLOVES WHEN HANDLING THE BLADE. SHARP EDGES COULD CAUSE INJURY.

Only replace the blade with a genuine Ozito replacement blade, as this will ensure top performance and safety under all conditions.

- To remove the blade bolt, hold the blade firmly and with a 13mm socket loosen the blade bolt by turning it anti-clockwise.

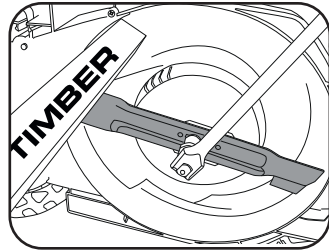

NOTE: A piece of timber will assist in holding the blade while removing or tightening the blade bolt.

- Remove the blade bolt and blade.

Replace the metal blade after 50 hours mowing or 2 years whichever is sooner. If the blade is cracked or damaged replace it with a new one.

- To fit the blade, place the blade over the centre hole aligning the lugs.
- Then retighten the fastening bolt with the universal wrench. The tightening torque should be approx. 25 Nm.

Cleaning, Maintenance and Storage

- Remove build up of grass in the ejector opening.
- Keep all nuts, bolts and screws tight to be sure the lawn mower is in a safe working condition.
- Check the catcher frequently for wear or deterioration.
- Replace worn or damaged parts for safety.
- Only use the replacement blade and blade bolt specified for this product.
- Be careful during adjustments of the lawn mower to prevent entrapment of the fingers between moving blade and fixed parts of the machine.
- When not in use, the mower should be stored in a dry, frost-free location, out of reach of children. If the housing of the mower requires cleaning, do not use solvents but a moist soft cloth and brush only.
- Frequently check the wheel threads are firm and tight.

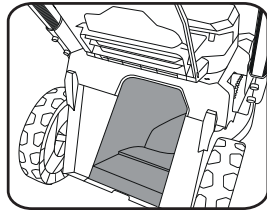

Note: Ozito Industries will not be responsible for any damage or injuries caused by the repair of the lawn mower by an unauthorised person or by mishandling of the lawn mower. This tool is designed for DIY use - use in commercial or industrial environments will void the warranty.

Battery protection system

The tool is equipped with the battery protection system, which helps to ensure a long service life.

The output power automatically cuts off during operation when the tool and/or battery are placed under the following situations:

- When the tool is overloaded:**
If this occurs, release the start/stop lever safety key and batteries and remove causes of overload, then reinsert the safety key and batteries, then press and hold the lock-off button and pull the start stop lever again to restart.
- When the remaining battery capacity becomes low:**
Recharge the battery pack.

Note: The indicated capacity may be lower than the actual level during use or immediately after using the tool.

CARING FOR THE ENVIRONMENT



Power tools that are no longer usable should not be disposed of with household waste but in an environmentally friendly way. Please recycle where facilities exist. Check with your local council authority for recycling advice.



Recycling packaging reduces the need for landfill and raw materials. Reuse of recycled material decreases pollution in the environment. Please recycle packaging where facilities exist. Check with your local council authority for recycling advice.

TROUBLESHOOTING

Problem	Cause	Remedy
Mower is not starting	Possible clogging	Check underneath the mower and clear out as necessary
	Battery is low in charge	Charge battery
	Battery not inserted properly	Insert battery pack correctly
	Grass too long	Raise the cutting height to reduce starting load
	Safety key not inserted correctly	Fit correctly
	Telescopic handle assembled incorrectly.	Ensure the Handle Angle Quick-release Lever is secure on both sides and one of the three positions available is selected.
Mower is hard to push	Height of cut too low	Raise cutting height
	Cutting blade blunt	Replace blade
	Possible clogging	Check underneath the mower and clear out as necessary
	Grass too long	Raise the cutting height and walk slower
	Grass too dense	Raise the cutting height and walk slower and cut more frequently
	Wet grass	Wait until the grass dries before mowing
Motor stops while cutting	Height of cut too low	Raise the cutting height
	Battery has no power	Charge batteries
Mower is not catching grass properly	Height of cut too low	Raise the cutting height
	Wet grass	Wait until the grass dries before mowing
Mower vibrating	Bent or damaged blade	Replace blade

DESCRIPTION OF SYMBOLS

V	Volts	Hz	Hertz
a.c./~	Alternating current	W	Watts
dc/—	Direct Current	\emptyset	Diameter
mA	Milliamperes	No	No load speed
/min	Revolutions or reciprocation per minute		Double insulated
Nm	Newton Meters		Warning
IPX1	Ingress protection from water	Ah	Amp hour
	Regulatory compliance mark (RCM)	mm	Millimetre
	Read instruction manual to reduce the risk of injury.		
	Sound power level 96dB		Pull out Safety Key before carrying out any repair work.
	The equipment's operating time depends on the battery with the lower charge level. Therefore, only use rechargeable batteries which are charged to the same level.		
	Always keep the lawnmower on the ground when mowing. Tilting or lifting the lawnmower may cause stones to be thrown out.		
	Keep bystanders away. Do not mow whilst people especially children or pets are in the mowing area.		
	Beware of severing toes or hands. Do not put hands or feet near a rotating blade.		
	Wear hearing and eye protection.		
	Do not mow in the rain or leave the lawnmower outdoors while raining.		

Spare parts can be ordered from the Special Orders Desk at your local Bunnings Warehouse.

Visit www.ozito.com.au or contact Ozito Customer Service:

Australia 1800 069 486, New Zealand 0508 069 486

E-mail: enquiries@ozito.com.au



ELECTRICAL SAFETY



WARNING! When using electric machines basic safety precautions should always be followed to reduce the risk of fire, electric shock and personal injury.

- Read the whole manual carefully and make sure you know how to switch the machine off in an emergency, before operating the machine. Save these instructions and other documents supplied with this machine for future reference.
- This appliance is not intended for use by persons (including children) with reduced physical, sensory or mental capabilities, or lack of experience and knowledge, unless they have been given supervision or instruction concerning use of the appliance by a person responsible for their safety. Children should be supervised to ensure that they do not play with the appliance.

- This machine is compatible and only to be used with all batteries & chargers from the Ozito PXC range. Refer to the PXC battery and charger manuals for information regarding charging, use and storage.
- **WARNING!** Always remove the battery from the machine:
 - when the batteries are to be charged,
 - when the machine is left unattended,
 - when the machine is being checked, cleaned, or having maintenance work done,
 - when the machine is to be stored,
 - or if the machine vibrates abnormally.
- Do not combine different types of batteries or new and used batteries.
- Do not use modified or damaged batteries.



GENERAL MACHINE SAFETY WARNINGS



WARNING! Read all safety warnings, instructions, illustrations and specifications provided with this machine. Failure to follow all instructions listed below may result in electric shock, fire and/or serious injury.

Save all warnings and instructions for future reference.

The term "machine" in the warnings refers to your mains-operated (corded) machine or battery-operated (cordless) machine.

1) Work area safety

- Keep work area clean and well lit.** Cluttered or dark areas invite accidents.
- Do not operate machines in explosive atmospheres, such as in the presence of flammable liquids, gases or dust.** Machines create sparks which may ignite the dust or fumes.
- Keep children and bystanders away while operating a machine.** Distractions can cause you to lose control.

2) Electrical safety

- Machine plugs must match the outlet. Never modify the plug in any way. Do not use any adapter plugs with earthed (grounded) machines.** Unmodified plugs and matching outlets will reduce risk of electric shock.
- Avoid body contact with earthed or grounded surfaces, such as pipes, radiators, ranges and refrigerators.** There is an increased risk of electric shock if your body is earthed or grounded.
- Do not expose machines to rain or wet conditions.** Water entering a machine will increase the risk of electric shock.
- Do not abuse the cord. Never use the cord for carrying, pulling or unplugging the machine. Keep cord away from heat, oil, sharp edges or moving parts.** Damaged or entangled cords increase the risk of electric shock.
- When operating a machine outdoors, use an extension cord suitable for outdoor use.** Use of a cord suitable for outdoor use reduces the risk of electric shock.
- If operating a machine in a damp location is unavoidable, use a residual current device (RCD) protected supply.** Use of an RCD reduces the risk of electric shock.

3) Personal safety

- Stay alert, watch what you are doing and use common sense when operating a machine. Do not use a machine while you are tired or under the influence of drugs, alcohol or medication.** A moment of inattention while operating machines may result in serious personal injury.
- Use personal protective equipment. Always wear eye protection.** Protective equipment such as a dust mask, non-skid safety shoes, hard hat or hearing protection used for appropriate conditions will reduce personal injuries.
- Prevent unintentional starting. Ensure the switch is in the off-position before connecting to power source and/or battery pack, picking up or carrying the machine.** Carrying machines with your finger on the switch or energising machines that have the switch on invites accidents.
- Remove any adjusting key or wrench before turning the machine on.** A wrench or a key left attached to a rotating part of the machine may result in personal injury.
- Do not overreach. Keep proper footing and balance at all times.** This enables better control of the machine in unexpected situations.
- Dress properly. Do not wear loose clothing or jewellery. Keep your hair and clothing away from moving parts.** Loose clothes, jewellery or long hair can be caught in moving parts.
- If devices are provided for the connection of dust extraction and collection facilities, ensure these are connected and properly used.** Use of dust collection can reduce dust-related hazards.
- Do not let familiarity gained from frequent use of machines allow you to become complacent and ignore machine safety principles.** A careless action can cause severe injury within a fraction of a second.

4) Machine use and care

- Do not force the machine. Use the correct machine for your application.** The correct machine will do the job better and safer at the rate for which it was designed.
- Do not use the machine if the switch does not turn it on and off.** Any machine that cannot be controlled with the switch is dangerous and must be repaired.
- Disconnect the plug from the power source and/or remove the battery pack, if detachable, from the machine before making any adjustments, changing accessories, or storing machines.** Such preventive safety measures reduce the risk of starting the machine accidentally.
- Store idle machines out of the reach of children and do not allow persons unfamiliar with the machine or these instructions to operate the machine.** Machines are dangerous in the hands of untrained users.
- Maintain machines and accessories. Check for misalignment or binding of moving parts, breakage of parts and any other condition that may affect the machine's operation. If damaged, have the machine repaired before use.** Many accidents are caused by poorly maintained machines.
- Keep cutting machines sharp and clean.** Properly maintained cutting machines with sharp cutting edges are less likely to bind and are easier to control.
- Use the machine, accessories and machine bits etc. in accordance with these instructions, taking into account the working conditions and the work to be performed.** Use of the machine for operations different from those intended could result in a hazardous situation.
- Keep handles and grasping surfaces dry, clean and free from oil and grease.** Slippery handles and grasping surfaces do not allow for safe handling and control of the machine in unexpected situations.

5) Battery machine use and care

- Recharge only with the charger specified by the manufacturer.** A charger that is suitable for one type of battery pack may create a risk of fire when used with another battery pack.
- Use machines only with specifically designated battery packs.** Use of any other battery packs may create a risk of injury and fire.
- When battery pack is not in use, keep it away from other metal objects, like paper clips, coins, keys, nails, screws or other small metal objects, that can make a connection from one terminal to another.** Shorting the battery terminals together may cause burns or a fire.
- Under abusive conditions, liquid may be ejected from the battery; avoid contact. If contact accidentally occurs, flush with water. If liquid contacts eyes, additionally seek medical help.** Liquid ejected from the battery may cause irritation or burns.
- Do not use a battery pack or machine that is damaged or modified.** Damaged or modified batteries may exhibit unpredictable behaviour resulting in fire, explosion or risk of injury.
- Do not expose a battery pack or machine to fire or excessive temperature.** Exposure to fire or temperature above 130°C may cause explosion.
- Follow all charging instructions and do not charge the battery pack or machine outside the temperature range specified in the instructions.** Charging improperly or at temperatures outside the specified range may damage the battery and increase the risk of fire.

6) Service

- Have your machine serviced by a qualified repair person using only identical replacement parts.** This will ensure that the safety of the machine is maintained.
- Never service damaged battery packs.** Service of battery packs should only be performed by the manufacturer or authorized service providers.



LAWN MOWER SAFETY WARNINGS



WARNING! If not used properly this lawn mower can be dangerous!

This lawn mower can cause serious injury to the operator and others; the warnings and safety instructions must be followed to ensure reasonable safety and efficiency in using this lawn mower. The operator is responsible for following the warning and safety instructions in this manual and on the lawn mower. Never use the mower unless the catcher or guards provided by the manufacturer are in the correct position.

1) Training

- Read the instructions carefully. Be familiar with the controls and the proper use of the appliance.
- Never allow children or people unfamiliar with these instructions to use the appliance. Local regulations may restrict the age of the operator.
- Never mow while people, especially children, or pets are nearby.
- The operator or user is responsible for accidents or hazards occurring to other people or their property
- Know your controls. Read the manual carefully. Learn how to stop the engine quickly in an emergency.

2) Preparation

- While mowing, always wear substantial footwear and long trousers.
- Do not operate the appliance when barefoot or wearing open sandals.
- Thoroughly inspect the area where the appliance is to be used and remove all stones, sticks, wires, bones, and other foreign objects. They could be thrown by the blade.
- Before using, always visually inspect to see that the blades, blade bolts and cutter assembly are not worn or damaged. Replace worn or damaged blades and bolts in sets to preserve balance.

DAMAGED BLADES AND WORN BOLTS ARE MAJOR HAZARDS.

- On multi-bladed appliances, take care as rotating one blade can cause other blades to rotate.

3) Operation

- Mow only in daylight or in good artificial light.
- Avoid operating the appliance in wet grass, where feasible.
- Always be sure of your footing on slopes.
- Walk, never run.
- For wheeled rotary mowers, mow across the face of slopes, never up and down.
- Exercise extreme caution when changing direction on slopes.
- Do not mow excessively steep slopes.
- Use extreme caution when reversing or pulling the appliance towards you.
- Never cut grass while walking backwards.
- Stop the blade(s) if the appliance has to be tilted for transportation when crossing surfaces other than grass, and when transporting the appliance to and from the area to be mowed such as gravel drives, walks or roads.
- Never operate the appliance with defective guards or shields, or without safety devices, for example deflectors and/or grass catchers, in place.
- Start the motor according to instructions and with feet well away from the blade(s).

- Do not tilt the appliance when starting the motor, except if the appliance has to be tilted for starting. In this case, do not tilt it more than absolutely necessary and lift only the part which is away from the operator. Always ensure that both hands are in the operating position before returning the appliance to the ground.
- Do not put hands or feet near or under rotating parts. For rotary mowers, keep clear of the discharge opening at all times.
- Never pick up or carry an appliance while the motor is running.
- Stop the motor:
 - whenever you leave the machine;
 - before clearing a blockage;
 - before checking, cleaning or working on the appliance;
 - after striking a foreign object. Inspect the appliance for damage and make repairs as necessary;
 - if the appliance starts to vibrate abnormally (check immediately).
- Do not over-speed the mower or alter governor settings. Excessive speed is dangerous and shortens mower life.

4) Maintenance and storage

- Keep all nuts, bolts, and screws tight to be sure the appliance is in safe working condition.
- Check the grass catcher frequently for wear or deterioration.
- Replace worn or damaged parts for safety.
- For cylinder mowers, be careful during adjustment of the appliance to prevent entrapment of the fingers between moving blades and fixed parts of the appliance.
- Store the mower in a well-ventilated room away from naked flames such that may be found in hot water heaters.
- Remove batteries and safety key when changing blade.



WARNING! When servicing, use only identical replacement parts. Use of any other parts may create a hazard or cause product damage. To ensure safety and reliability, all repairs should be performed by a qualified service technician.



DANGER! Always remove the batteries from the lawn mower:

- when the equipment is left unattended,
- when the equipment is being checked, cleaned, or having maintenance work done,
- or if the equipment vibrates abnormally.



18V LITHIUM ION

4.0Ah BATTERY

INSTRUCTION MANUAL

SPECIFICATIONS

Input:	18V
Battery Capacity:	4.0Ah Li-ion
Power Consumption:	72Wh
Weight:	0.65kg

ozito.com.au

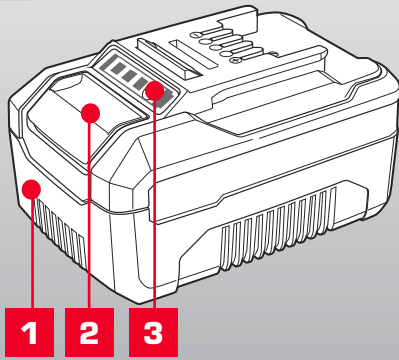

1. Battery
2. Battery Release Button
3. Charge Indicator Button

3 YEAR
REPLACEMENT WARRANTY

PXBP-400

DESCRIPTION OF SYMBOLS

V	Volts	Hz	Hertz
ac~	Alternating Current	W	Watts
dc	Direct Current	Ah	Amp Hour
mA	Milliamperes		Warning
	Lithium Ion Battery		Do not store or use battery in temperatures exceeding 50°C
	Recycle Battery		Do not put in the rubbish
	Do not incinerate		Do not get battery wet
	Regulatory Compliance Mark (RCM)		Do not store battery when the charge is low; store between 40-60%.

CARING FOR THE ENVIRONMENT



Power tools that are no longer usable should not be disposed of with household waste but in an environmentally friendly way. Please recycle where facilities exist. Check with your local council authority for recycling advice.



Recycling packaging reduces the need for landfill and raw materials. Reuse of recycled material decreases pollution in the environment. Please recycle packaging where facilities exist. Check with your local council authority for recycling advice.

BATTERY & CHARGER SAFETY WARNINGS

Before using the charger or battery read all instructions and cautionary markings on the charger, battery pack and the product using the battery pack. Do not lose these safety instructions.

Battery Warnings

1. The battery pack is not fully charged out of the carton. First read the safety instructions and then follow the charging notes and procedures.
2. For optimum battery performance avoid low discharge cycles. Charge the battery pack frequently.
3. Use and store the battery pack in dry conditions with low humidity between 0-50°C, ideally at 15°C. Avoid exposing battery pack and charger to direct sunlight.
4. Do not keep battery pack in places where temperatures are liable to reach over 50°C, such as in a car, metal shed or similar that is in direct sunlight.
5. Do not ignite the battery pack or expose it to fire. There is a risk of explosion!
6. Do not exhaustively discharge batteries. Exhaustive discharge will damage the battery cells. The most common cause of exhaustive discharge is long-term storage and continued use of low-charge batteries. Always store the battery with some charge. Charge the batteries every 2-3 months to restore charge. Stop working as soon as the performance of the battery falls noticeably or the electronic protection system triggers.
7. Protect batteries and the tool from overloads. Overloads will quickly result in overheating and cell damage inside the battery housing without this overheating being apparent externally.
8. Avoid damage and shocks. Do not use batteries which have been dropped from a height of more than one meter or strong external impact, even if the housing of the battery pack appears to be undamaged. The battery cells inside the battery may have suffered serious damage.
9. If the battery pack suffers overloading and overheating, the integrated protective cut-off will switch off the equipment. Do not press the ON/OFF switch on the tool if the protective cut-off has actuated. This may damage the battery pack. Allow the battery to cool to room temperature before use.
10. Use only original battery packs. The use of other batteries may result in injuries, explosion and a fire risk.
11. Protect your rechargeable battery against moisture, rain and high humidity. Moisture, rain and high humidity can cause dangerous cell damage. Never charge or use batteries which have been exposed to moisture, rain or high humidity.
12. Never attempt to open the battery pack for any reason. If the plastic housing of the battery pack is damaged, do not use the battery.
13. When battery pack is not in use, keep it away from other metal objects, like paper clips, coins, keys, nails, screws or other small metal objects, that can make a connection from one terminal to another. Shorting the battery terminals together may cause burns or a fire.
14. Under abusive conditions, liquid may be ejected from the battery; avoid contact. If accidental contact occurs, flush with water and seek medical help immediately. Liquid ejected from the battery may cause irritation or burns.
15. Do not use a battery pack or tool that is damaged or modified. Damaged or modified batteries may exhibit unpredictable behaviour resulting in fire, explosion or risk of injury.
16. Do not expose a battery pack or tool to fire or excessive temperature. Exposure to fire or temperature above 130°C may cause explosion.
17. Never service damaged battery packs. Service of battery packs should only be performed by the manufacturer.
18. Do not disassemble Battery. This may result in a risk of electric shock, electrocution or fire.

Charger Warnings

19. Please check the data marked on the rating plate of the battery charger. Ensure to only connect the battery charger to a power supply with the voltage marked on the rating plate.
20. Protect the battery charger and its cable from damage and sharp edges. Have damaged cables repaired by an authorised service agent before use.
21. Keep the battery charger, batteries and the cordless tool out of children's reach.
22. Do not use damaged battery chargers.
23. Do not use the supplied battery charger to charge other cordless tools. Only charge Ozito Power X Change rechargeable batteries with an Ozito Power X Change Charger.
24. The battery pack may become warm during use. Allow the battery pack to cool to room temperature before commencing with the charging.
25. Do not over-charge batteries. Do not exceed the maximum charging times. These charging times only apply to discharged batteries. Frequent insertion of a charged or partly charged battery pack will result in over-charging and cell damage. Do not leave fully charged batteries in the charger.
26. Charge the battery pack in dry conditions with low humidity between 10-40°C. Avoid exposing battery pack and charger to direct sunlight.
27. Do not use batteries which have suffered deformation during the charging process or shows any other signs of abnormalities including, excessive curvature of the housing, gassing, hissing or cracking.
28. Never fully discharge the battery pack. A complete discharge of the battery pack will lead to premature ageing of the battery cells.
29. Never charge the batteries unsupervised.
30. Do not cover or place any object on top of the charger, place the charger away from heat sources.
31. To reduce risk of damage to the electric plug and cord, pull by the plug rather than the cord when disconnecting the charger.
32. Make sure the cord is located so that it will not be stepped on, tripped over, or otherwise subjected to damage or stress.
33. An extension cord should not be used unless necessary. Use of an improper extension cord could result in the risk of fire, electric shock or electrocution.
34. Do not disassemble charger. This may result in a risk of electric shock, electrocution or fire.
35. To reduce risk of electric shock, unplug the charger from the outlet before attempting any cleaning. Removing the battery pack will not reduce this risk.
36. Do not use the cordless tool or the battery charger near vapours and inflammable liquids.

ELECTRICAL SAFETY



WARNING! When using mains-powered tools, basic safety precautions, including the following, should always be followed to reduce risk of fire, electric shock, personal injury and material damage.

Read the whole manual carefully and make sure you know how to switch the tool off in an emergency, before operating the tool. Save these instructions and other documents supplied with this tool for future reference.

Note: The supply of 230V and 240V on Ozito tools are interchangeable for Australia and New Zealand. If the supply cord is damaged, it must be replaced by the manufacturer, its service agent or similarly qualified persons in order to avoid hazard.

Note: Double insulation does not take the place of normal safety precautions when operating this tool. The insulation system is for added protection against injury resulting from a possible electrical insulation failure within the tool.

Using an Extension Lead

Always use an approved extension lead suitable for the power input of this tool. Before use, inspect the extension lead for signs of damage, wear and ageing. Replace the extension lead if damaged or defective.

When using an extension lead on a reel, always unwind the lead completely. Use of an extension lead not suitable for the power input of the tool or which is damaged or defective may result in a risk of fire and electric shock.

To reduce the risk of electric shock, we recommend the use of a residual current device (rated 30mA or less).

This appliance is not intended for use by persons (including children) with reduced physical, sensory or mental capabilities, or lack of experience and knowledge, unless they have been given supervision or instruction concerning use of the appliance by a person responsible for their safety.

Children should be supervised to ensure that they do not play with the appliance.

1. OPERATION

Only use the battery pack with Ozito Power X Change 18V cordless products.

CHARGING YOUR LITHIUM ION BATTERY

This battery has been shipped in a low charge condition, and requires charging prior to use. Allow several cycles of charging and discharging (through use with a compatible tool) for the battery to reach its optimum performance / runtime.

This battery is compatible with chargers from the 18V Ozito Power X Change range available through your local Bunnings Warehouse. Product availability may differ.

1. Insert the power plug of the charger into the mains socket outlet. The green LED will begin to flash when properly connected to power supply.
2. Insert the battery pack into the battery charger.
3. Remove battery from the charger once fully charged. Disconnect the charger from the power supply.

Note: The battery pack can become a little warm during the charging. This is normal.

If the battery pack fails to charge, check:

- if there is voltage at the socket outlet
- that the battery and charger are properly connected.

If the battery pack still fails to charge, please contact our customer service center.

BATTERY CHARGE INDICATOR

The purchased battery is equipped with a battery charge indicator to show the state of the battery charge.

Press the charge indicator button and look to see which LED lights.

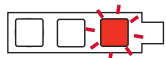
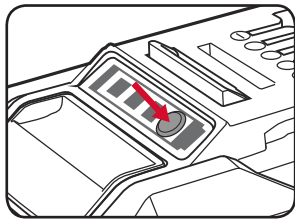

Battery requires immediate charging

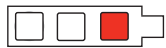

Low state of charge, requires charging soon.

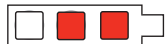

Mid state of charge



Full state of charge.

Note: The battery needs to be removed from the tool to check the state of charge.

BATTERY PROTECTION SYSTEM

The tool is equipped with a battery protection system, which helps to ensure longevity of the battery.

The output power automatically cuts off during operation when the tool and/or battery are placed under the following situations:

- When the tool is overloaded:
If this occurs, release the trigger switch and remove causes of overload, then pull the switch trigger again to restart.
- When the remaining battery capacity becomes low:
Recharge the battery pack.

Note: The battery protection system does not in any way damage the tool.

Note: The indicated capacity may be lower than the actual level during use or immediately after using the tool.

WARRANTY

IN ORDER TO MAKE A CLAIM UNDER THIS WARRANTY YOU MUST RETURN THE PRODUCT TO YOUR NEAREST BUNNINGS WAREHOUSE WITH YOUR BUNNINGS REGISTER RECEIPT. PRIOR TO RETURNING YOUR PRODUCT FOR WARRANTY PLEASE TELEPHONE OUR CUSTOMER SERVICE HELPLINE:

Australia 1800 069 486

New Zealand 0508 069 486

TO ENSURE A SPEEDY RESPONSE PLEASE HAVE THE MODEL NUMBER AND DATE OF PURCHASE AVAILABLE. A CUSTOMER SERVICE REPRESENTATIVE WILL TAKE YOUR CALL AND ANSWER ANY QUESTIONS YOU MAY HAVE RELATING TO THE WARRANTY POLICY OR PROCEDURE.

The benefits provided under this warranty are in addition to other rights and remedies which are available to you at law.

Our goods come with guarantees that cannot be excluded at law. You are entitled to a replacement or refund for a major failure and for compensation for any other reasonably foreseeable loss or damage. You are also entitled to have the goods repaired or replaced if the goods fail to be of acceptable quality and the failure does not amount to a major failure.

Generally you will be responsible for all costs associated with a claim under this warranty, however, where you have suffered any additional direct loss as a result of a defective product you may be able to claim such expenses by contacting our customer service helpline above.

36 MONTH REPLACEMENT WARRANTY

Your product is guaranteed for a period of **36 months from the original date of purchase** and is intended for DIY (Do It Yourself) use only. If a product is defective it will be replaced in accordance with the terms of this warranty. Warranty excludes consumable parts.

WARNING

The following actions will result in the warranty being void.

- If the tool has been operated on a supply voltage other than that specified on the tool.
- If the tool shows signs of damage or defects caused by or resulting from abuse, accidents or alterations.
- Failure to perform maintenance as set out within the instruction manual.
- If the tool is disassembled or tampered with in any way.

0121

ONLINE MANUAL

Scan this QR Code with your mobile device to take you to the online manual.



OZITO Australia/New Zealand (Head Office)
25 Fox Drive, Dandenong South, Victoria, Australia 3175.

PXBP-400



18V LITHIUM ION

MULTI BATTERY FAST CHARGER

INSTRUCTION MANUAL

SPECIFICATIONS

Input:	220-240V ~AC 50-60Hz
Output 1:	18V DC, 3.0A
Output 2:	18V DC, 3.0A
Battery Charge Time:	30Min - PXBP-150 (18V 1.5Ah)
	40Min - PXBP-200 (18V 2.0Ah)
	50Min - PXBP-250 (18V 2.5Ah)
	60Min - PXBP-300 (18V 3.0Ah)
	75Min - PXBP-400 (18V 4.0Ah)
	120Min - PXBP-520 (18V 5.2Ah)
	100Min - PXUBP-520 (18V 5.2Ah Ultra)

ozito.com.au

- Charging Unit LEDs
- Charging Unit

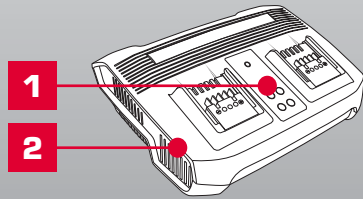

PXMBC-002

3 YEAR
REPLACEMENT WARRANTY

DESCRIPTION OF SYMBOLS

V	Volts	Hz	Hertz
A	Amperes	Ah	Amp Hour
	Read Instruction Manual		Double Insulated
	Indoor Use Only		Do not dispose of in rubbish
	Do not charge battery in temperatures exceeding 40°C		Regulatory Compliance Mark (RCM)
	3.15A Slow Blow Fuse		Warning

CARING FOR THE ENVIRONMENT



Power tools that are no longer usable should not be disposed of with household waste but in an environmentally friendly way. Please recycle where facilities exist. Check with your local council authority for recycling advice.



Recycling packaging reduces the need for landfill and raw materials. Reuse of recycled material decreases pollution in the environment. Please recycle packaging where facilities exist. Check with your local council authority for recycling advice.

BATTERY & CHARGER SAFETY WARNINGS

Before using the charger or battery read all instructions and cautionary markings on the charger, battery pack and the product using the battery pack. Do not lose these safety instructions.

Battery Warnings

- The battery pack is not fully charged out of the carton. First read the safety instructions and then follow the charging notes and procedures.
- For optimum battery performance avoid low discharge cycles. Charge the battery pack frequently.
- Use and store the battery pack in dry conditions with low humidity between 0-50°C, ideally at 15°C. Avoid exposing battery pack and charger to direct sunlight.
- Do not keep battery pack in places where temperatures are liable to reach over 50°C, such as in a car, metal shed or similar that is in direct sunlight.
- Do not ignite the battery pack or expose it to fire. There is a risk of explosion!
- Do not exhaustively discharge batteries. Exhaustive discharge will damage the battery cells. The most common cause of exhaustive discharge is long-term storage and continued use of low-charge batteries. Always store the battery with some charge. Charge the batteries every 2-3 months to restore charge. Stop working as soon as the performance of the battery falls noticeably or the electronic protection system triggers.
- Protect batteries and the tool from overloads. Overloads will quickly result in overheating and cell damage inside the battery housing without this overheating being apparent externally.
- Avoid damage and shocks. Do not use batteries which have been dropped from a height of more than one meter or strong external impact, even if the housing of the battery pack appears to be undamaged. The battery cells inside the battery may have suffered serious damage.
- If the battery pack suffers overloading and overheating, the integrated protective cut-off will switch off the equipment. Do not press the ON/OFF switch on the tool if the protective cut-off has actuated. This may damage the battery pack. Allow the battery to cool to room temperature before use.
- Use only original battery packs. The use of other batteries may result in injuries, explosion and a fire risk.
- Protect your rechargeable battery against moisture, rain and high humidity. Moisture, rain and high humidity can cause dangerous cell damage. Never charge or use batteries which have been exposed to moisture, rain or high humidity.
- Never attempt to open the battery pack for any reason. If the plastic housing of the battery pack is damaged, do not use the battery.
- When battery pack is not in use, keep it away from other metal objects, like paper clips, coins, keys, nails, screws or other small metal objects, that can make a connection from one terminal to another. Shorting the battery terminals together may cause burns or a fire.
- Under abusive conditions, liquid may be ejected from the battery; avoid contact. If accidental contact occurs, flush with water and seek medical help immediately. Liquid ejected from the battery may cause irritation or burns.
- Do not use a battery pack or tool that is damaged or modified. Damaged or modified batteries may exhibit unpredictable behaviour resulting in fire, explosion or risk of injury.
- Do not expose a battery pack or tool to fire or excessive temperature. Exposure to fire or temperature above 130°C may cause explosion.
- Never service damaged battery packs. Service of battery packs should only be performed by the manufacturer.
- Do not disassemble Battery. This may result in a risk of electric shock, electrocution or fire.

Charger Warnings

- Please check the data marked on the rating plate of the battery charger. Ensure to only connect the battery charger to a power supply with the voltage marked on the rating plate.
- Protect the battery charger and its cable from damage and sharp edges. Have damaged cables repaired by an authorised service agent before use.
- Keep the battery charger, batteries and the cordless tool out of children's reach.
- Do not use damaged battery chargers.
- Do not use the supplied battery charger to charge other cordless tools. Only charge Ozito Power X Change rechargeable batteries with an Ozito Power X Change Charger.
- The battery pack may become warm during use. Allow the battery pack to cool to room temperature before commencing with the charging.
- Do not over-charge batteries. Do not exceed the maximum charging times. These charging times only apply to discharged batteries. Frequent insertion of a charged or partly charged battery pack will result in over-charging and cell damage. Do not leave fully charged batteries in the charger. Overcharging batteries may result in a risk of fire.
- Charge the battery pack in dry conditions with low humidity between 10-40°C. Avoid exposing battery pack and charger to direct sunlight.
- Do not use batteries which have suffered deformation during the charging process or shows any other signs of abnormalities including, excessive curvature of the housing, gassing, hissing or cracking.
- Never fully discharge the battery pack. A complete discharge of the battery pack will lead to premature ageing of the battery cells.
- Never charge the batteries unsupervised.
- Do not cover or place any object on top of the charger, place the charger away from heat sources.
- To reduce risk of damage to the electric plug and cord, pull by the plug rather than the cord when disconnecting the charger.
- Make sure the cord is located so that it will not be stepped on, tripped over, or otherwise subjected to damage or stress.
- An extension cord should not be used unless necessary. Use of an improper extension cord could result in the risk of fire, electric shock or electrocution.
- Do not disassemble charger. This may result in a risk of electric shock, electrocution or fire.
- To reduce risk of electric shock, unplug the charger from the outlet before attempting any cleaning. Removing the battery pack will not reduce this risk.
- Do not use the cordless tool or the battery charger near vapours and inflammable liquids.
- Keep away from readily combustible material whilst charging.

ELECTRICAL SAFETY



WARNING! When using mains-powered tools, basic safety precautions, including the following, should always be followed to reduce risk of fire, electric shock, personal injury and material damage.

Read the whole manual carefully and make sure you know how to switch the tool off in an emergency, before operating the tool. Save these instructions and other documents supplied with this tool for future reference.



Note: The supply of 230V and 240V on Ozito tools are interchangeable for Australia and New Zealand. This tools charger is double insulated therefore no earth wire is required.

If the supply cord is damaged, it must be replaced by the manufacturer, its service agent or similarly qualified persons in order to avoid hazard.

Note: Double insulation does not take the place of normal safety precautions when operating this tool. The insulation system is for added protection against injury resulting from a possible electrical insulation failure within the tool.

Using an extension lead

Always use an approved extension lead suitable for the power input of this tool. Before use, inspect the extension lead for signs of damage, wear and ageing. Replace the extension lead if damaged or defective.

When using an extension lead on a reel, always unwind the lead completely. Use of an extension lead not suitable for the power input of the tool or which is damaged or defective may result in a risk of fire and electric shock.

To reduce the risk of electric shock, we recommend the use of a residual current device (rated 30mA or less).

This appliance is not intended for use by persons (including children) with reduced physical, sensory or mental capabilities, or lack of experience and knowledge, unless they have been given supervision or instruction concerning use of the appliance by a person responsible for their safety.

Children should be supervised to ensure that they do not play with the appliance.

1. CHARGING A BATTERY

WARNING! THE CHARGER SHOULD BE PROTECTED BY A RESIDUAL CURRENT DEVICE (RATED AT 30MA OR LESS).

WARNING! DO NOT COVER OR PLACE ANY OBJECT ON TOP OF THE CHARGER; PLACE THE CHARGER AWAY FROM HEAT SOURCES.

1. Connect the charger to the power supply and the LED will flash green showing power is being supplied to the charger.

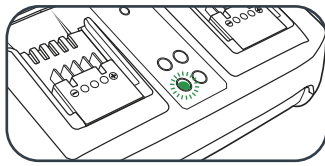

2. Align and then slide the ribs on the battery into the recess in the charger.

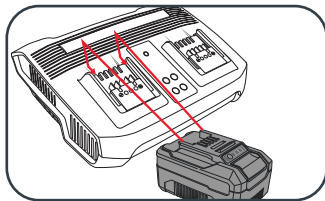

3. The red LED will illuminate while the battery charges.

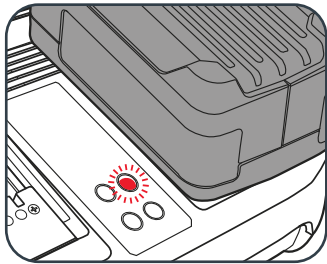

4. The green LED will illuminate once the battery is charged.

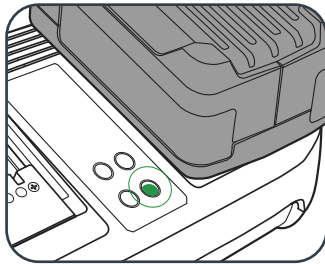

Charger LED Indicator Lights

LED Indicator	Situation
GREEN (Flashing)	Stand By (no battery pack is inserted)
RED (Flashing)	Battery is charging (low charge)
RED (Illuminated)	Battery is fast charging (mid charge)
GREEN (Illuminated)	Battery is 85% - 100% charged and is ready for use.
BOTH (Illuminated)	Battery pack is too hot or too cold (charging will begin automatically when battery reaches correct charging temperature).
BOTH (Flashing)	The battery is defective, charging is no longer possible. Do not charge. Contact Ozito Customer Service.

WARNING! NEVER LEAVE THE BATTERIES CHARGING UNSUPERVISED.

Mounting The Charging Unit On A Wall

The charging unit can be mounted to a wall or workbench. The correct dimensions for drill holes can be found on the back of the charging unit; a template for the mounting hole locations can also be found on the Ozito website.

Note: When mounting on a wall you must use suitable screws, e.g.M3 pan-head screws, in order to prevent damage to the housing and risk of falling.

ONLINE MANUAL

Scan this QR Code with your mobile device to take you to the online manual.



2. MAINTENANCE

- Disconnect the charger from power source before cleaning.
- Keep the charger in a dry place out of reach of children.
- If the enclosure of the charger requires cleaning, do not use solvents. Use a dry, soft cloth only to wipe down the surface. Never let any liquid get inside the charger; never immerse any part of the charger.
- There are no other parts inside the charger which require maintenance. Do not take the charger apart. If the charger is damaged, contact your supplier or the manufacturer.

WARRANTY

IN ORDER TO MAKE A CLAIM UNDER THIS WARRANTY YOU MUST RETURN THE PRODUCT TO YOUR NEAREST BUNNINGS WAREHOUSE WITH YOUR BUNNINGS REGISTER RECEIPT. PRIOR TO RETURNING YOUR PRODUCT FOR WARRANTY PLEASE TELEPHONE OUR CUSTOMER SERVICE HELPLINE:

Australia 1800 069 486

New Zealand 0508 069 486

TO ENSURE A SPEEDY RESPONSE PLEASE HAVE THE MODEL NUMBER AND DATE OF PURCHASE AVAILABLE. A CUSTOMER SERVICE REPRESENTATIVE WILL TAKE YOUR CALL AND ANSWER ANY QUESTIONS YOU MAY HAVE RELATING TO THE WARRANTY POLICY OR PROCEDURE.

The benefits provided under this warranty are in addition to other rights and remedies which are available to you at law.

Our goods come with guarantees that cannot be excluded at law. You are entitled to a replacement or refund for a major failure and for compensation for any other reasonably foreseeable loss or damage. You are also entitled to have the goods repaired or replaced if the goods fail to be of acceptable quality and the failure does not amount to a major failure.

Generally you will be responsible for all costs associated with a claim under this warranty, however, where you have suffered any additional direct loss as a result of a defective product you may be able to claim such expenses by contacting our customer service helpline above.

36 MONTH REPLACEMENT WARRANTY

Your product is guaranteed for a period of **36 months from the original date of purchase** and is intended for DIY (Do It Yourself) use only. If a product is defective it will be replaced in accordance with the terms of this warranty. Warranty excludes consumable parts.

WARNING

The following actions will result in the warranty being void.

- If the tool has been operated on a supply voltage other than that specified on the tool.
- If the tool shows signs of damage or defects caused by or resulting from abuse, accidents or alterations.
- Failure to perform maintenance as set out within the instruction manual.
- If the tool is disassembled or tampered with in any way.

18V Multi-Battery Charger Wall Mount Template

NOTE: Please print the template at ACTUAL SIZE. Do not fit or resize the template to maintain the correct dimensions.

140mm



Mounting Instructions:

1. Stick the back of this template to the wall in the desired mounting location.
2. Drill 3 x 2mm holes according to the circles in the template location.
3. Remove template.
4. Screw 3 timber screws with $\varnothing 7\text{mm}$ (or smaller) screw heads into the pre-drilled holes. Leave them protruding by about 5mm.
5. Hang Multi-Battery Charger by the 3 screws and slide it left to lock it in place.

110mm