



18V LITHIUM ION

# 210MM MITRE SAW

## INSTRUCTION MANUAL

### SPECIFICATIONS

Voltage:	18V
No Load Speed:	3,000/min
Blade Diameter:	210mm (8 <sup>1</sup> / <sub>4</sub> "
Blade Teeth:	40TCT
Blade Bore:	30mm
Cutting Capacity:	
0° Mitre x 0° Bevel:	120x60mm
45° Mitre x 0° Bevel:	83x60mm
0° Mitre x 45° Bevel:	120x34mm
45° Mitre x 45° Bevel:	83x34mm
Weight:	9.3kg

ozito.com.au

**5 YEAR**  
REPLACEMENT WARRANTY

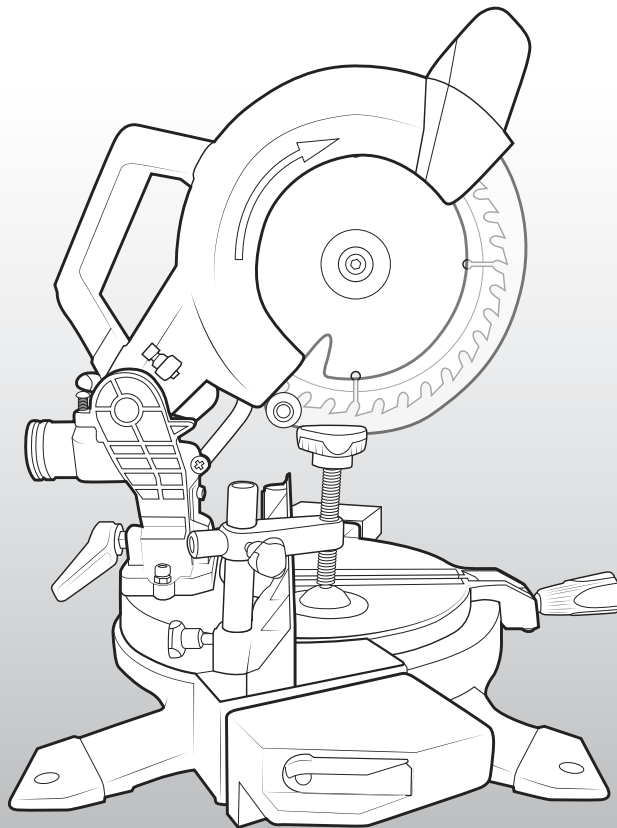

### WHAT'S IN THE BOX

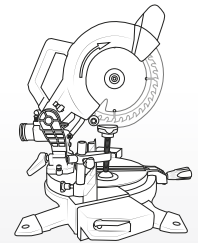

Compound Mitre Saw



Dust Bag

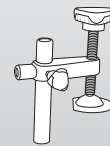

Material Clamp



Hex Key

**PXCMSS-210**

## WARRANTY

IN ORDER TO MAKE A CLAIM UNDER THIS WARRANTY YOU MUST RETURN THE PRODUCT TO YOUR NEAREST BUNNINGS WAREHOUSE WITH YOUR BUNNINGS REGISTER RECEIPT. PRIOR TO RETURNING YOUR PRODUCT FOR WARRANTY PLEASE TELEPHONE OUR CUSTOMER SERVICE HELPLINE:

**Australia 1800 069 486**

**New Zealand 0508 069 486**

TO ENSURE A SPEEDY RESPONSE PLEASE HAVE THE MODEL NUMBER AND DATE OF PURCHASE AVAILABLE. A CUSTOMER SERVICE REPRESENTATIVE WILL TAKE YOUR CALL AND ANSWER ANY QUESTIONS YOU MAY HAVE RELATING TO THE WARRANTY POLICY OR PROCEDURE.

### WARNING

The following actions will result in the warranty being void.

- If the tool has been operated on a supply voltage other than that specified on the tool.
- If the tool shows signs of damage or defects caused by or resulting from abuse, accidents or alterations.
- Failure to perform maintenance as set out within the instruction manual.
- If the tool is disassembled or tampered with in any way.

The benefits provided under this warranty are in addition to other rights and remedies which are available to you at law.

Our goods come with guarantees that cannot be excluded at law. You are entitled to a replacement or refund for a major failure and for compensation for any other reasonably foreseeable loss or damage. You are also entitled to have the goods repaired or replaced if the goods fail to be of acceptable quality and the failure does not amount to a major failure.

Generally you will be responsible for all costs associated with a claim under this warranty, however, where you have suffered any additional direct loss as a result of a defective product you may be able to claim such expenses by contacting our customer service helpline above.

### 5 YEAR REPLACEMENT WARRANTY

Your Product is guaranteed for a period of 60 months from the original date of purchase and is intended for DIY (Do It Yourself) use only. If a product is defective it will be replaced in accordance with the terms of this warranty. **Lithium Ion batteries and chargers are covered by a 36 month warranty** and are excluded from the warranty extension. Warranty excludes consumable parts, for example: cutting blades.

# KNOW YOUR PRODUCT

## CORDLESS MITRE SAW

- |                      |                        |
|----------------------|------------------------|
| 1 Handle Lock Button | 9 Mitre Guide          |
| 2 Spindle Lock       | 10 Mitre Locking Knob  |
| 3 Head Locking Pin   | 11 Blade               |
| 4 Material Clamp     | 12 Lower Blade Guard   |
| 5 Extension Supports | 13 Depth Stop          |
| 6 On/Off Trigger     | 14 Dust Port           |
| 7 Bevel Guide        | 15 Bevel Locking Lever |
| 8 Rear Fence         | 16 Material Stop       |

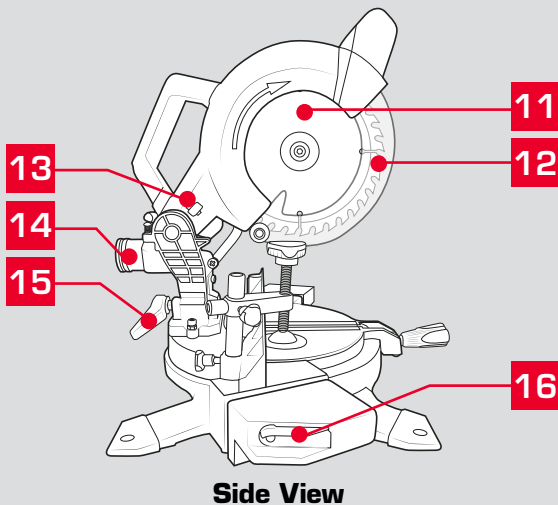
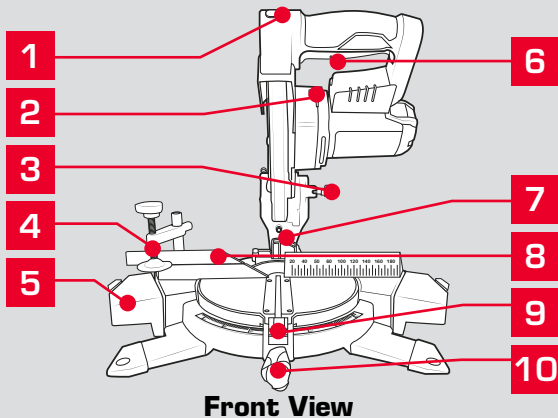

## BATTERY & CHARGER

This tool is compatible with all battery and chargers from the Ozito Power X Change Range.

For optimal performance, we recommend the use of a 3.0Ah battery or higher to operate this Power X Change Mitre Saw.

### ONLINE MANUAL

Scan this QR Code with your mobile device to take you to the online manual.



# SETUP & PREPARATION

## 1. FITTING THE BATTERY & CLAMP

### Inserting & Removing the Battery

- 1 Slide the battery into the seating above the saw handle until it clicks into place.

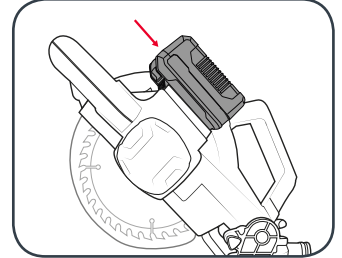

- 2 To remove, press and hold the battery release tab and then slide out.

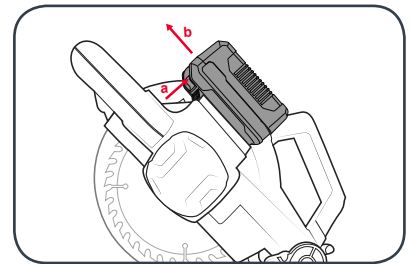

### Attaching / Adjusting the Material Clamp

- 1 Loosen the clamp locking knobs and insert the shaft into the hole.

**Note:** The clamp can be mounted on either side of the blade.

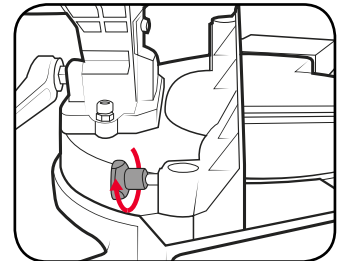

- 2 Adjust the material clamp into the desired location and tighten all locking knobs.

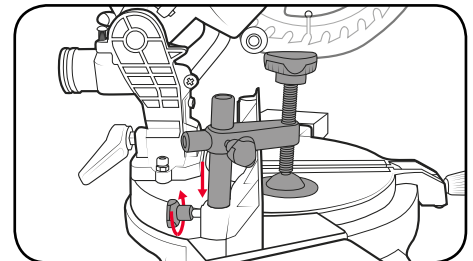

- 3 The large screw can be lowered onto the timber workpiece in order to secure the workpiece while performing a cut.

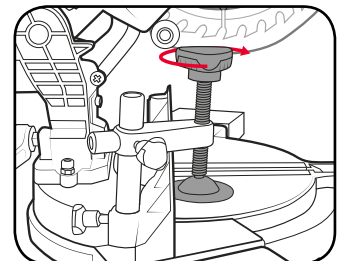

**Note:** When performing bevel cuts, the work clamp must be on the opposite side of the bevel (otherwise it will interfere with the cutting action).

**5 YEAR**  
REPLACEMENT WARRANTY

## 2. EXTENSION SUPPORTS

**WARNING!** ENSURE THE TOOL IS SWITCHED OFF AND THE BATTERY IS REMOVED BEFORE PERFORMING ANY OF THE FOLLOWING TASKS.

### Adjusting the Extension Supports

The extension supports can be extended outwards allowing additional support when cutting longer workpieces.

- 1 Press the support locking lever underneath the support arm to allow it to slide.

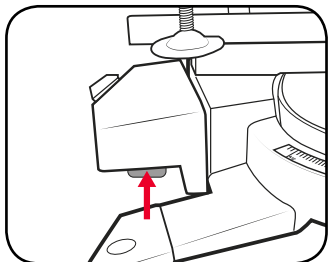

- 2 Slide the extension support to the desired location and then release the locking lever to secure in position.

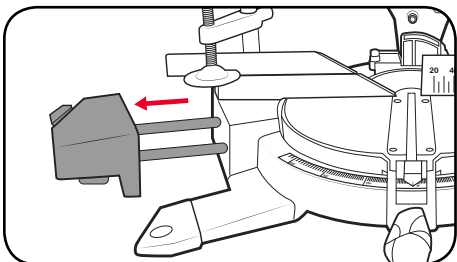

### Using the Material Stops

The extension supports allow feature a material stop that can be raised in order to contact the end of the workpiece. This feature is used to quickly position material enabling you to cut multiple pieces at the same length.

- 1 Raise the material stop upwards, then adjust the extension support to the desired distance away from the blade.

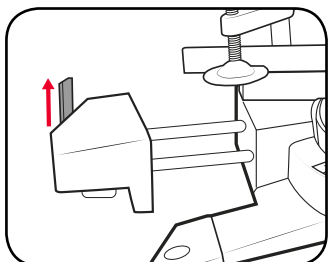

- 2 Once the material stop is set, you can place the workpiece onto the table and slide up to the stop. Secure the material and then complete the cut.

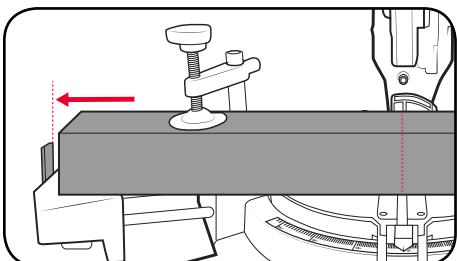

## 3. ADJUSTMENTS

### Bevel Adjustment

- 1 Loosen bevel locking lever at the rear of the saw.

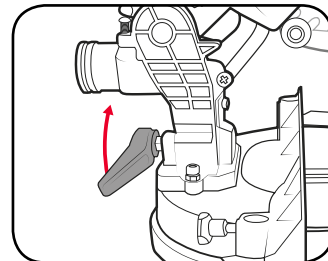

- 2 Tilt the head using the bevel scale as a reference.

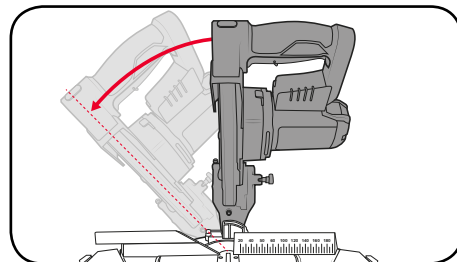

- 3 Tighten the bevel locking lever to secure at the desired bevel angle.

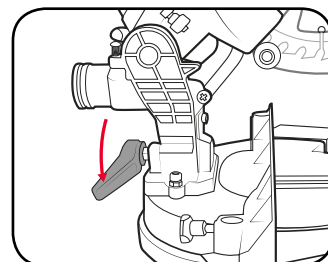

**WARNING!** ENSURE THE BEVEL LOCK IS TIGHT BEFORE MAKING A CUT. FAILURE TO DO SO MAY RESULT IN THE CUTTING HEAD MOVING DURING OPERATION AND CAUSE SERIOUS PERSONAL INJURY.

### Mitre Adjustment

- 1 Loosen the mitre locking knob at the front of the saw.

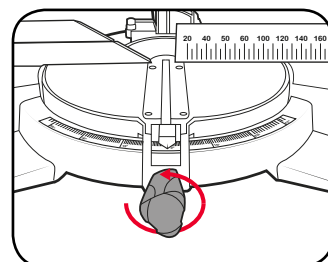

- 2 Rotate the mitre table to the desired mitre angle and then lock in position using the mitre locking knob.

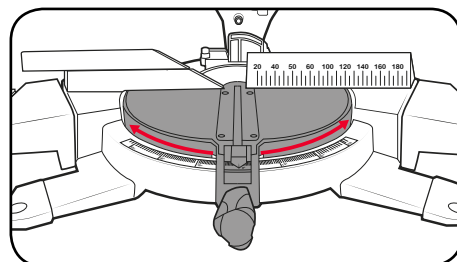

**Note:** The mitre table features positive click stops at 0°, 5°, 10°, 15°, 22.5°, 30°, 35°, 40° and 45° for quick setting of common mitre angles.

## Fence Adjustment

- 1 Make sure that no part of the tool contacts the upper fence when bevel or compound mitre cutting.

**Note:** Always make a dry run with the saw turned off and check clearance. Tighten securely before making a cut.

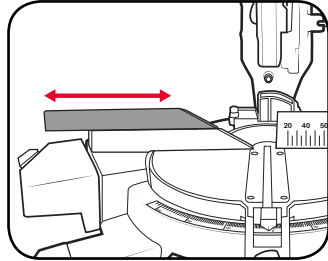

## Depth Adjustment (Trenching)

Trenching refers to restricting the depth of cut and permits a "trench" to be cut in the workpiece.

- 1 Ensure the cutting head is raised, and then loosen the depth locking nut.

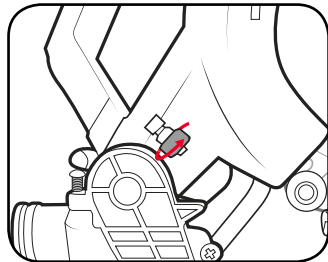

- 2 Using a hex key, adjust the depth adjustment screw so that the cutting head stops at the desired height when lowered.

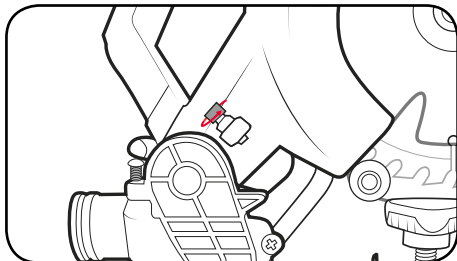

- 3 Once the desired setting is achieved, tighten the depth locking nut.

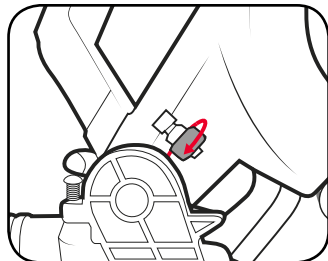

## 4. CONTROLS

### Turning On the Worklight or Laser Line

To switch the worklight on, press the worklight switch up into the on position.

To switch the laser line on, press the laser line switch up into the on position.

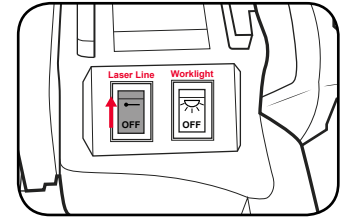
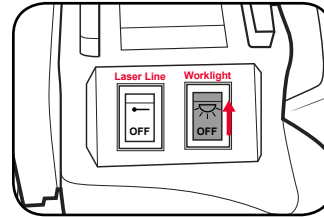

**WARNING!** DO NOT STARE DIRECTLY AT THE LASER BEAM OR WORKLIGHT.

### Head Locking Pin

- 1 To unlock the saw head, press down slightly on the handle and then pull and rotate the head locking pin 90 degrees.
- 2 To lock the head down, press the head down and then pull and rotate the head locking pin 90 degrees.

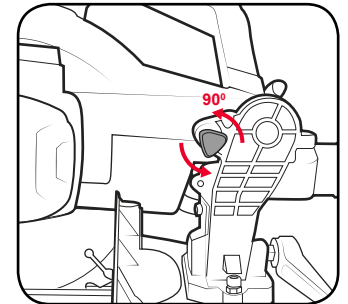

### Starting the Mitre Saw

- 1 Unlock the trigger by pressing the lever on the trigger sideways.

Then unlock the handle motion by pressing the handle lock button at the front of the handle.

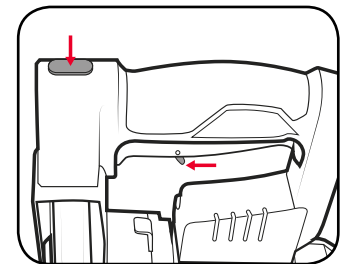

- 2 Squeeze the on/off trigger to start the saw.

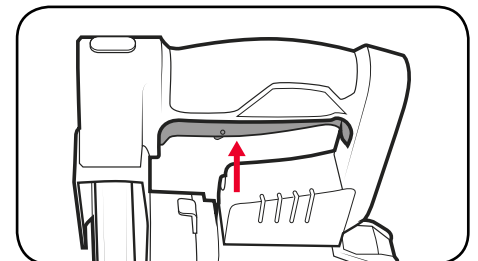

**Note:** Allow the saw to reach full speed before beginning a cut.

# OPERATION

## 5. VARIOUS CUTS

**WARNING!** DO NOT USE THE MITRE SAW TO CUT METAL OR MASONRY.

### Straight Cutting

A straight cut is made by cutting the grain of the workpiece. A 90° straight cut is made with the mitre scale set in the 0°.

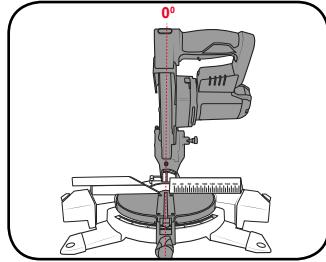
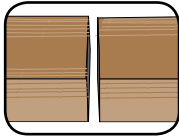

### Mitre Cuts

Mitre cuts are made with the mitre scale set at an angle other than 0°.

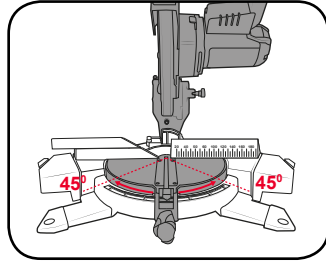
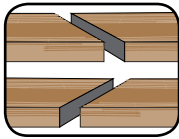

### Bevel Cutting

A bevel cut is made by cutting across the grain of the workpiece with the blade angled to the mitre table.

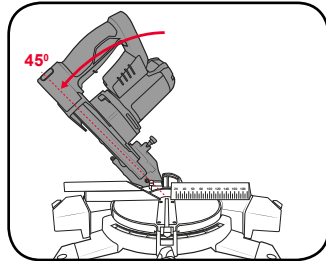
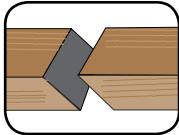

### Compound Mitre Cuts

A compound mitre cut involves using a mitre angle and a bevel angle at the same time.

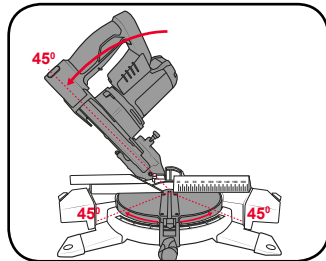
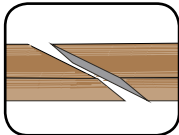

**CAUTION!** FOR ALL TYPES OF CUTS ENSURE THE SAW IS LOCKED INTO POSITION.

## 6. MAKING A CUT

- 1 Mark the cutting line on the workpiece and then place onto the mitre table with one edge up against the rear fence.

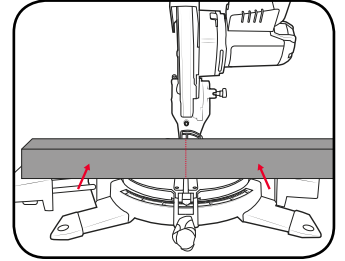

- 2 Secure the workpiece and ensure all mitre saw adjustments are locked tightly.

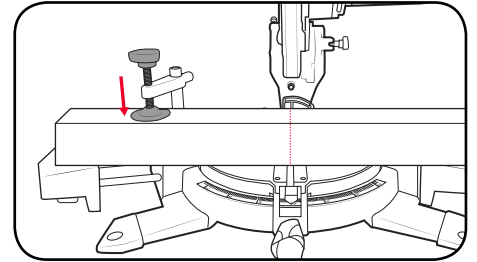

- 3 Start the saw and allow the blade to reach full speed.

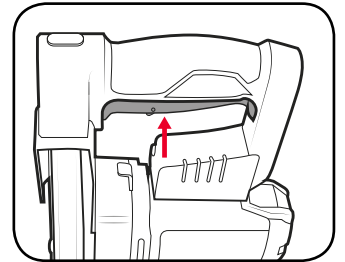

- 4 Perform the cut through the timber smoothly. Once complete, release the on/off trigger and remove the saw from the workpiece.

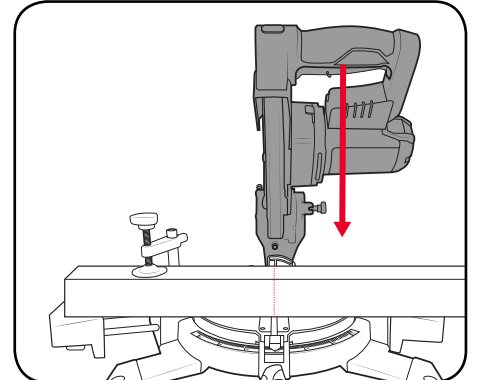

**Note:** Never force the saw. Use light and continuous pressure.

## 7. CHANGING THE BLADE



**WARNING!** ENSURE THE TOOL IS SWITCHED OFF AND DISCONNECTED FROM THE POWER SUPPLY BEFORE PERFORMING ANY OF THE FOLLOWING TASKS.

**CAUTION!** NEVER TRY TO USE A BLADE THAT IS LARGER THAN THE STATED CAPACITY OF THE MITRE SAW. IT MIGHT COME INTO CONTACT WITH THE BLADE GUARDS AND RISK PERSONAL INJURY OR DAMAGE TO THE MITRE SAW. THIS WILL NOT BE COVERED UNDER WARRANTY.

**CAUTION!** NEVER USE A BLADE THAT IS TOO THICK TO ALLOW THE OUTER FLANGE TO ENGAGE WITH THE FLATS ON THE SPINDLE. IT WILL PREVENT THE BLADE SCREW FROM PROPERLY SECURING THE BLADE ONTO THE SPINDLE.

**CAUTION!** ENSURE THAT THE CORRECT BLADE BUSH THAT MAY BE REQUIRED SUITS THE SPINDLE AND BLADES THAT ARE FITTED.

The tool is recommended for wood cutting only and is not recommended for use with abrasive wheels or masonry/diamond cutting wheels. Only use 210mm wood cutting blades.

- 1 Ensure the cutting head is raised. Press the spindle lock button in while rotating the blade clockwise using a hex key in the central blade bolt.

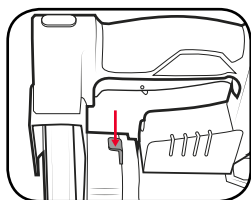

- 2 Once the spindle lock stops the blades rotation, rotate the blade bolt clockwise to remove the bolt and outer flange.

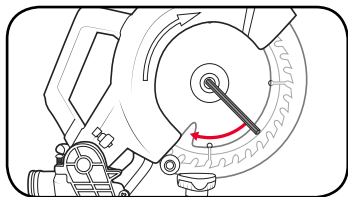

- 3 Raise the lower blade guard and remove the blade from the spindle.

**Note:** Make sure the inner flange stays in place on the spindle.

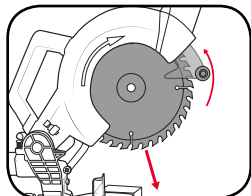

- 4 Install the new the blade over the spindle and onto the inner flange.

**Note:** Ensure the blade is fitted so that the arrow on the blade matches the same direction as the arrow on the guard.

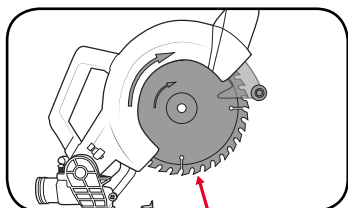

- 5 Fit the outer flange by placing the cupped side against the blade followed by the washer and blade bolt.

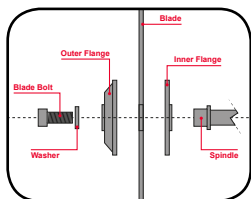

- 6 Depress the spindle lock and then tighten the blade bolt using a hex key in an anti-clockwise direction.

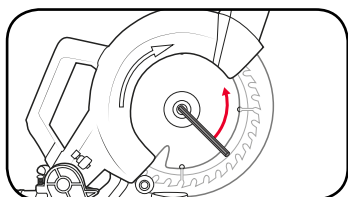

Make sure the lower guard operates smoothly and properly protects you from the blade before using the saw.



**WARNING!** TO ENSURE THE CORRECT BLADE ROTATION, ALWAYS INSTALL THE BLADE WITH THE BLADE TEETH POINTING DOWNWARDS. ENSURE THE ARROW DIRECTION ON THE BLADE CORRESPONDS WITH THE ARROW ON THE UPPER BLADE GUARD.

## 8. SAW ALIGNMENT

The mitre saw should be set-up fairly accurate out of the box, but if the saw becomes misaligned, you can follow the instructions below to adjust the tool.

### Fence Alignment

- 1 Set the mitre angle to 0°, lock the cutting head down and remove the upper rear fence by loosening the fence locking knob all the way out.

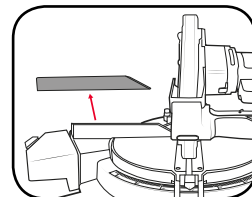

- 2 Loosen slightly all 4 hex bolts securing the rear fence in place.

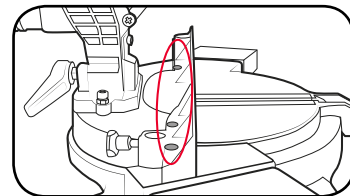

- 3 Lay a carpenters square on the table with one edge along the blade and the other along the fence. Any inaccuracy should be visible.

**Note:** The square must contact the blade, not the teeth, for an accurate reading.

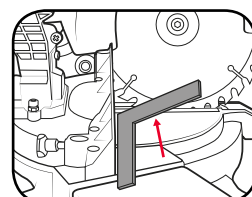

- 4 Gently tap the fence into position so that the fence is perfectly perpendicular to the blade. Retighten the bolts.

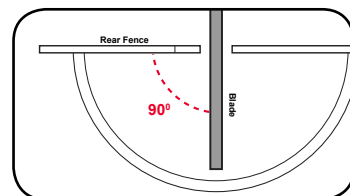

- 5 Make a test cut and repeat this process until the fence is adjusted accurately. Then you can reattach the upper rear fence.

### Bevel Alignment

The saw has 2 bump stops that limit the bevel angle to 0° and 45°. If the bevel angle becomes inaccurate, these stops can be readjusted by following the steps below.

- 1 Set the bevel angle to 0°, lock the cutting head down and loosen the bevel locking lever.

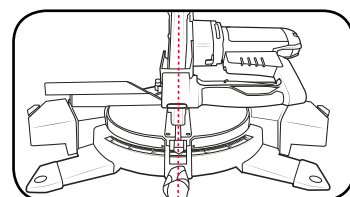

- 2 Lay a carpenters square along the blade with one edge along the blade. Any inaccuracy should be visible.

**Note:** The square must contact the blade, not the teeth, for an accurate reading.

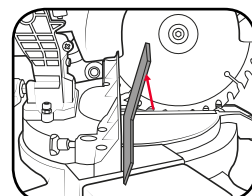

- 3 Loosen the right bump stop nut and adjust the screw until the blade is perpendicular with the table. Then tighten the nut to secure in position.

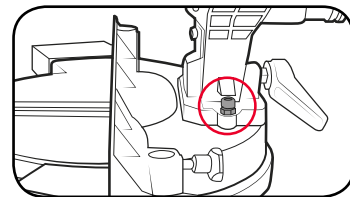

- 4 Repeat steps 2 and 3 for the left bump stop using a 45° angle carpenters triangle.

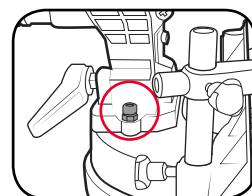

# MAINTENANCE



**WARNING!** ALWAYS ENSURE THE TOOL HAS COMPLETELY STOPPED AND THE BATTERY IS REMOVED PRIOR TO ANY MAINTENANCE.

- Keep ventilation slots of the mitre saw clean at all times to ensure efficient operation.
- After each use, blow air through the tool housing to ensure it is free from all dust, dirt, etc. Build up of dust, dirt particles may cause the tool to overheat and shorten the life of the tool.
- Empty the dust bag regularly.
- If the housing of the saw requires cleaning, do not use solvents but a moist soft cloth or soft brush only.
- Never let any liquid get inside the tool, never immerse any part of the tool into liquid.
- No lubrication is necessary as the tool has sealed bearings.
- When not in use, the mitre saw should be stored in a dry, frost free location not within the reach of children.

Note: Ozito Industries will not be responsible for any damage or injuries caused by the repair of the circular saw by an unauthorised person or by mishandling of the circular saw.

## Battery protection system

The tool is equipped with the battery protection system, which helps to ensure a long service life.

The output power automatically cuts off during operation when the tool and/or battery are placed under the following situations:

- **When the tool is overloaded:**

If this occurs, release the trigger switch and remove causes of overload, then pull the switch trigger again to restart.

- **When the remaining battery capacity becomes low:**

Recharge the battery pack.

**Note:** The battery protection system does not in any way damage the tool.

**Note:** The indicated capacity may be lower than the actual level during use or immediately after using the tool.

# TROUBLESHOOTING

## LED lights do not illuminate on charger

Check the charging adaptor is securely plugged into the wall outlet.

Check the battery is firmly connected to the charging cradle.

Check that the charging jack is securely connected to the charging cradle.

## The battery has a short run time

Ensure the battery is properly charged. It will take 4-5 charging cycles before the battery reaches optimum charge and run time. On the initial charge, the battery requires 5 hours of charging. Subsequent charging only requires 3-5 hours.

## Sparking visible through the housing air vents

A small amount of sparking may be visible through the housing vents. This is normal and does not indicate a problem.

## Worklight or laser line is not turning on

The worklight only turns on once a charged battery is fitted and the worklight or laser light switch is switched on.

Ensure the light source is not covered in dust. Use a dry cloth to wipe away dust.

## Mitre Saw Tips

Allow the saw to reach full speed before beginning a cut.

Never force the saw. Use light and continuous pressure.

When cutting is interrupted, to resume cutting, start the saw and allow the blade to reach full speed, re-enter the cut slowly and resume cutting.

When cutting across the grain, the fibres of the wood have a tendency to tear and lift. Advancing the saw slowly minimizes this effect.



# BATTERY AND CHARGER SAFETY WARNINGS

THIS MANUAL CONTAINS IMPORTANT SAFETY AND OPERATING INSTRUCTIONS FOR YOUR BATTERY CHARGER.

1. Before using the charger read all instructions and cautionary markings on the charger, battery pack and the product using the battery pack.
2. This charger is not intended for any uses other than charging rechargeable batteries. Any other use may result in risk of fire, electric shock or electrocution.
3. Do not place any object on top of the charger or place the charger on a soft surface that may result in excessive internal heat. Place the charger in a position away from any heat source.
4. To reduce risk of damage to the electric plug and cord, pull by the plug rather than the cord when disconnecting the charger.
5. Make sure the cord is located so that it will not be stepped on, tripped over, or otherwise subjected to damage or stress.
6. An extension cord should not be used unless absolutely necessary. Use of an improper extension cord could result in the risk of fire, electric shock or electrocution.
7. Do not operate the charger if it has received a sharp blow, been dropped or otherwise damaged in any way. Have it checked by an electrician or power tool repairer.
8. Do not disassemble charger. Take it to an electrician or power tool repairer when service or repair is required. Incorrect reassembly may result in a risk of electric shock, electrocution or fire.
9. To reduce risk of electric shock, unplug the charger from the outlet before attempting any cleaning. Removing the battery pack will not reduce this risk.
10. Never attempt to connect 2 chargers together.
11. DO NOT store or use the tool and battery pack in locations where the temperature may reach or exceed 40°C (such as inside sheds or metal buildings in summer).
12. The charger is designed to operate on standard household electrical power (240 volts). Do not attempt to use it on any other voltage!
13. The battery pack is not fully charged out of the carton. First read the safety instructions and then follow the charging notes and procedures.
14. The longest life and best performance can be obtained if the battery pack is charged when the air temperature is between 18 - 24°C. Do not charge the battery pack in an air temperature below 10°C or above 40°C. This is important and will prevent damage to the battery pack.
15. Do not incinerate the battery pack even if it is seriously damaged or is completely worn out. The battery can explode in a fire.
16. Never attempt to open the battery pack for any reason. If the plastic housing of the battery pack breaks or cracks, immediately discontinue use and do not recharge.
17. During charging, the battery must be placed in a well ventilated area.

# CARING FOR THE ENVIRONMENT



Power tools that are no longer usable should not be disposed of with household waste but in an environmentally friendly way. Please recycle where facilities exist. Check with your local council authority for recycling advice.



Recycling packaging reduces the need for landfill and raw materials. Reuse of recycled material decreases pollution in the environment. Please recycle packaging where facilities exist. Check with your local council authority for recycling advice.

# SPARE PARTS

Spare parts can be ordered from the Special Orders Desk at your local Bunnings Warehouse.

For further information, or any parts not listed here, visit [www.ozito.com.au](http://www.ozito.com.au) or contact Ozito Customer Service:

Australia 1800 069 486

New Zealand 0508 069 486

E-mail: [enquiries@ozito.com.au](mailto:enquiries@ozito.com.au)

# DESCRIPTION OF SYMBOLS

	Volts		Hertz
	Alternating current		Watts
	Direct current		Diameter
	Milliamperes		Amp hour
	Regulatory Compliance Mark (RCM)		No load speed
	Warning		Read instruction manual



# ELECTRICAL SAFETY



**WARNING!** When using mains-powered tools, basic safety precautions, including the following, should always be followed to reduce risk of fire, electric shock, personal injury and material damage.

Read the whole manual carefully and make sure you know how to switch the tool off in an emergency, before operating the tool.

Save these instructions and other documents supplied with this tool for future reference.

The charger has been designed for 230V and 240V only. Always check that the power supply corresponds to the voltage on the rating plate.

Note: The supply of 230V and 240V on Ozito tools are interchangeable for Australia and New Zealand.



This tool's charger is double insulated; therefore no earth wire is required.

If the supply cord is damaged, it must be replaced by an electrician or a power tool repairer in order to avoid a hazard.

**Note:** Double insulation does not take the place of normal safety precautions when operating this tool. The insulation system is for added protection against injury resulting from a possible electrical insulation failure within the tool.

## Using an Extension Lead

Always use an approved extension lead suitable for the power input of this tool. Before use, inspect the extension lead for signs of damage, wear and ageing. Replace the extension lead if damaged or defective.

When using an extension lead on a reel, always unwind the lead completely. Use of an extension lead not suitable for the power input of the tool or which is damaged or defective may result in a risk of fire and electric shock.

The power supply for this product's charger should be protected by a residual current device (rated at 30mA or less). A residual current device reduces the risk of electric shock.



# GENERAL POWER TOOL SAFETY WARNINGS



**WARNING!** Read all safety warnings and all instructions. Failure to follow the warnings and instructions may result in electric shock, fire and/or serious injury.

Save all warnings and instructions for future reference. The term "power tool" in the warnings refers to your mains-operated (corded) power tool or battery-operated (cordless) power tool.

## 1. Work area safety

- Keep work area clean and well lit.** Cluttered or dark areas invite accidents.
- Do not operate power tools in explosive atmospheres, such as in the presence of flammable liquids, gases or dust.** Power tools create sparks which may ignite the dust or fumes.
- Keep children and bystanders away while operating a power tool.** Distractions can cause you to lose control.

## 2. Electrical safety

- Power tool plugs must match the outlet. Never modify the plug in any way. Do not use any adapter plugs with earthed (grounded) power tools.** Unmodified plugs and matching outlets will reduce risk of electric shock.
- Avoid body contact with earthed or grounded surfaces, such as pipes, radiators, ranges and refrigerators.** There is an increased risk of electric shock if your body is earthed or grounded.
- Do not expose power tools to rain or wet conditions.** Water entering a power tool will increase the risk of electric shock.
- Do not abuse the cord. Never use the cord for carrying, pulling or unplugging the power tool. Keep cord away from heat, oil, sharp edges or moving parts.** Damaged or entangled cords increase the risk of electric shock.
- When operating a power tool outdoors, use an extension cord suitable for outdoor use.** Use of a cord suitable for outdoor use reduces the risk of electric shock.
- If operating a power tool in a damp location is unavoidable, use a residual current device (RCD) protected supply.** Use of an RCD reduces the risk of electric shock.

## 3. Personal safety

- Stay alert, watch what you are doing and use common sense when operating a power tool. Do not use a power tool while you are tired or under the influence of drugs, alcohol or medication.** A moment of inattention while operating power tools may result in serious personal injury.
- Use personal protective equipment. Always wear eye protection.** Protective equipment such as dust mask, non-skid safety shoes, hard hat, or hearing protection used for appropriate conditions will reduce personal injuries.
- Prevent unintentional starting. Ensure the switch is in the off-position before connecting to power source and/or battery pack, picking up or carrying the tool.** Carrying power tools with your finger on the switch or energising power tools that have the switch on invites accidents.
- Remove any adjusting key or wrench before turning the power tool on.** A wrench or a key left attached to a rotating part of the power tool may result in personal injury.

- Do not overreach. Keep proper footing and balance at all times.** This enables better control of the power tool in unexpected situations.

- Dress properly. Do not wear loose clothing or jewellery. Keep your hair, clothing and gloves away from moving parts.** Loose clothes, jewellery or long hair can be caught in moving parts.

- If devices are provided for the connection of dust extraction and collection facilities, ensure these are connected and properly used.** Use of dust collection can reduce dust-related hazards.

- Do not let familiarity gained from frequent use of tools allow you to become complacent and ignore tool safety principles.** A careless action can cause severe injury within a fraction of a second.

## 4. Power tool use and care

- Do not force the power tool. Use the correct power tool for your application.** The correct power tool will do the job better and safer at the rate for which it was designed.
- Do not use the power tool if the switch does not turn it on and off.** Any power tool that cannot be controlled with the switch is dangerous and must be repaired.
- Disconnect the plug from the power source and/or the battery pack from the power tool before making any adjustments, changing accessories, or storing power tools.** Such preventive safety measures reduce the risk of starting the power tool accidentally.
- Store idle power tools out of the reach of children and do not allow persons unfamiliar with the power tool or these instructions to operate the power tool.** Power tools are dangerous in the hands of untrained users.
- Maintain power tools. Check for misalignment or binding of moving parts, breakage of parts and any other condition that may affect the power tool's operation. If damaged, have the power tool repaired before use.** Many accidents are caused by poorly maintained power tools.
- Keep cutting tools sharp and clean.** Properly maintained cutting tools with sharp cutting edges are less likely to bind and are easier to control.
- Use the power tool, accessories and tool bits etc. in accordance with these instructions, taking into account the working conditions and the work to be performed.** Use of the power tool for operations different from those intended could result in a hazardous situation.
- Keep handles and grasping surfaces dry, clean and free from oil and grease.** Slippery handles and grasping surfaces do not allow for safe handling and control of the tool in unexpected situations.

## 5. Service

- Have your power tool serviced by a qualified repair person using only identical replacement parts.** This will ensure that the safety of the power tool is maintained.



# CIRCULAR SAW SAFETY WARNINGS

This appliance is not intended for use by young or infirm persons unless supervised by a responsible person to ensure that they can use the appliance safely. Young children should be supervised to ensure that they do not play with the appliance.



## WARNING!

Before connecting a tool to a power source (battery) be sure that the voltage supply is the same as that specified on the nameplate of the tool. A power source with a voltage greater than that specified for the tool can result in serious injury to the user, as well as damage to the tool.

Using a power source with a voltage less than the nameplate rating is harmful to the motor.

Always disconnect the battery before making any adjustments or maintenance, including changing the blade.

When operating the saw, use safety equipment including safety goggles or shield, ear protection, dust mask and protective clothing including safety gloves.

- Ensure that there is adequate general or localised lighting.
- Do not use the saw unless the guards are in place.
- Do not use the saw to cut metal or masonry.
- Do not let anyone under 18 years operate this saw.
- Ensure that the operator is adequately trained in the use, adjustment and operation of the machine.
- Do not use this saw to cut firewood.
- Keep the area free of tripping hazards.
- Report faults in the machine, including guards and saw blades, as soon as they are discovered.
- Ensure that the machine is always fixed to a bench, whenever possible.
- Always stand to one side when operating the saw.
- Never use a cracked or distorted saw blade.
- When cutting round wood, use clamps that prevent the workpiece from turning on both sides of the blade.
- Never use your hands to remove sawdust, chips or waste close by the blade.
- Do not use blades of High Speed Steel (HSS blades).
- If the table insert is damaged or worn, have it replaced by a power tool repairer.
- Rags, cloths, cord and string and the like should never be left around the work area.
- Avoid cutting nails. Inspect the workpiece and remove all nails and other foreign objects before operating the saw.
- Support the work properly.
- Refrain from removing any cut-offs or other parts of the workpiece from the cutting area whilst the machine is running and the saw head is not in the rest position.
- Do not attempt to free a jammed blade before first stopping the machine and disconnecting the battery.

- Do not slow or stop a blade with a piece of wood. Let the blade come to rest without assistance.
- If you are interrupted when operating the saw, complete the process and switch off before locking up.
- Periodically check that all nuts, bolts and other fixings are properly tightened.
- Do not store materials or equipment above a machine in such a way that they could fall into it.
- Always hold the saw on parts that are insulated. If you accidentally cut into hidden wiring, the metal parts of the saw will become "live". Remove the battery immediately.
- Never saw near combustible liquids or gases.
- Note the direction of rotation of the motor and the blade.
- Do not lock the movable guard in the open position and always ensure that it is working properly, freely rotating and returning to fully cover the teeth of the blade.
- Connect the saw to a dust collection device and ensure that it is operating properly. As the operator of the saw, please make sure that you understand factors that influence exposure to dust, including the type of material to be cut, the importance of local extraction and the proper adjustment of hoods/baffles/chutes of your dust extraction system. We recommend that you always wear a dust mask when operating this saw.
- Wear gloves when handling saw blades and rough materials.
- Saw blades shall be carried in a holder wherever possible.
- Select saw blades in relation to the material being cut.
- Use correctly sharpened saw blades and observe the maximum speed marked on the blade.
- Take additional care when trenching (slotting).
- The mitre saw can be safely carried by the carrying handle but only once the battery has been disconnected and secured in the locked down position.
- Ensure that the arm is properly secure when bevelling.
- Keep the floor area around the machine level, well maintained and free of loose materials.
- Ensure that you are trained in the use, adjustment and operation of the machine.
- Do not remove any cut-offs from the cutting area until the mitre saw head is in the full upright position, the blade guard is fully enclosing the blade and the blade has come to a rest or complete stop.
- When cutting long pieces which extend well over the table width, ensure that the ends are adequately supported at the same height as the saw table top. Supports should be positioned in such a way to ensure that the workpiece does not fall to the ground once the cut has been made.

Operating Mitre Saws without the correct hearing protection may result in impairment of hearing.

A number of supports at regular intervals may be required if the workpiece is extremely long.

- Wear goggles
- Wear earmuffs
- Wear a breathing mask