

HERKULES®

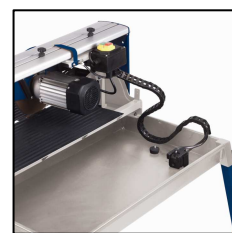

With four standard legs which are quick and easy to fit, the rugged STR 250 LED stone cutting machine is ideally suited for both stationary and mobile work. It offers a wide range of possibilities and is therefore a highly versatile tool for professional applications. The stone cutting machine can be used for the precise cutting of all kinds of concrete slabs, cobblestones, marble and granite slabs, and bricks and tiles, in a diversity of shapes and sizes. Only a few movements are required to perform both mitre and double mitre cuts and jolly cuts. An integrated coolant pump ensures that the diamond cutting wheel is perfectly cooled at all times while enabling you to work without interference from dust. **The swiveling cutting head enables workpieces of up to 570 mm in length to be cut with ease.**

The tile cutting machine is equipped with a LED-light, which illuminates the work area perfectly. **The LED-light can be removed from the machine and used as a pocket lamp or a spirit level.**

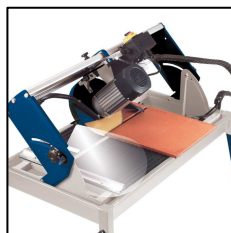
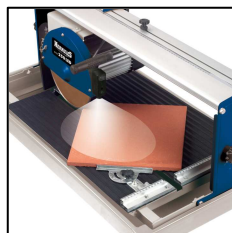
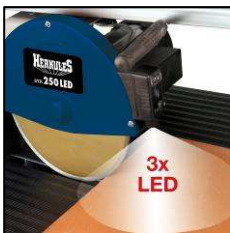

STR 250 LED Stone Cutting Machine with LED-light

Logistic Information:

Type:	STR 250 LED	Sales unit:	1 pc
Art. No.:	43.014.42	20°:	100 pcs
Ident No.:	01016	40°:	210 pcs
Bar code:	4006825 532678	40° HC:	-- pcs
Packaging:	1020 x 595 x 470 mm	Weight:	56.5 kgs (gross)



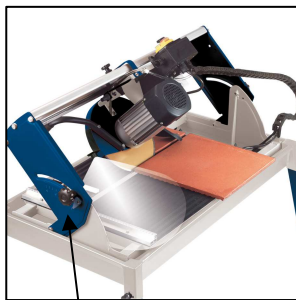
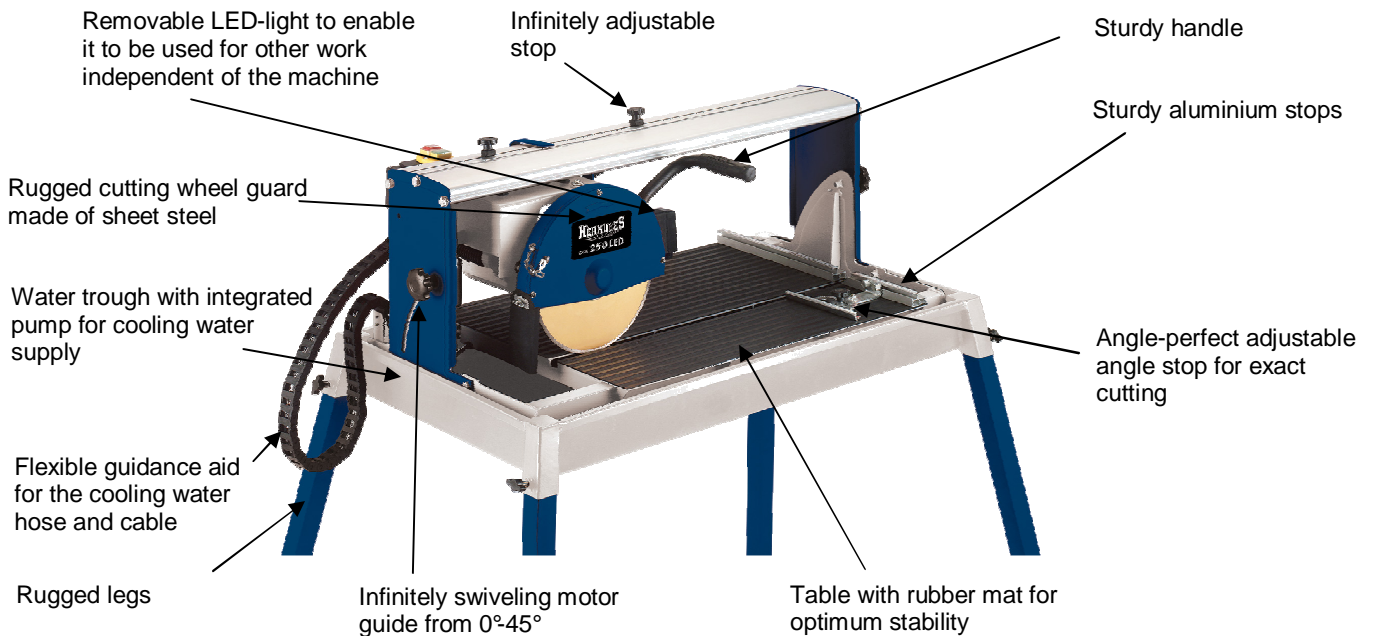

Ininitely swiveling motor guide from 0°-45°

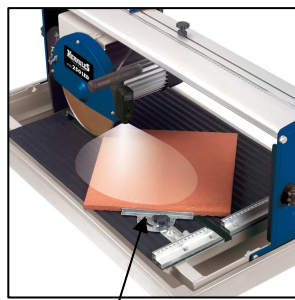

Angle-perfect adjustable angle stop for exact cutting

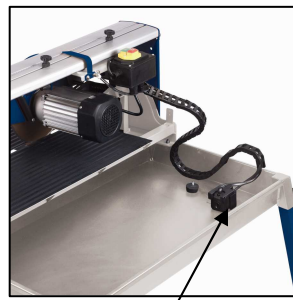

Water trough with integrated pump for cooling water supply



RCD plug for machine safety

Features:

- Removable LED-light to enable it to be used for other work independent of the machine
- RCD plug for machine safety
- 4-way ball bearing-mounted motor guide
- Ininitely swiveling motor guide from 0°-45°
- Angle-perfect adjustable angle stop
- Sturdy handle
- Large work table with rubber mat and sturdy aluminium stops
- Solid cutting wheel guard made of sheet steel
- Water trough with integrated pump for cooling water supply
- Rugged legs

Technical Data:

- Alternating current motor: 230 V ~ 50 Hz
- Power: 1,500 W S2 20 min
- Rotation speed n_0 : 3,000 min⁻¹
- Cutting depth 90°: max. 65 mm
- Cutting depth 45°: max. 48 mm
- Cutting length: max. 570 mm
- Cutting length for jolly cuts: max. 570 mm
- Bevel cuts: 0° - 45°
- Diamond wheel: Ø 250 x Ø 25.4 mm
- Protection class: IP 54
- Work table: 630 x 450 mm

Logistic Information:

Type:	STR 250 LED	Tool:	Stone cutting machine
Art. No.	43.014.42	Sales unit:	1 pc
Ident No.:	01016	20°:	100 pcs
Bar code:	4006825 532678	40°:	210 pcs
Packaging:	1020 x 595 x 470 mm	40° HC:	-- pcs
		Weight:	56.5 kg (gross)

