

# ozito

## SLIDING COMPOUND MITRE SAW

**1600W 210mm (8¼")**

### INSTRUCTION MANUAL

#### SPECIFICATIONS

Mains Voltage: 220–240V ~ 50Hz  
Motor Power: 1500W (S1); 1600W (S6 25%)  
No Load Speed: 5,200/min  
Blade: Ø210 x Ø30 x 2.4mm x 48T  
Bevel Range: 0° to 45° Left  
Mitre Range: -45° to 45° Left & Right  
Max. Cutting Capacities:  
Mitre 0° x Bevel 90°: 65 x 305mm  
Mitre 45° x Bevel 90°: 65 x 215mm  
Mitre 0° x Bevel 45°: 33 x 305mm  
Mitre 45° x Bevel 45° (Left): 33 x 215mm  
Weight: 12.5kg

[ozito.com.au](http://ozito.com.au)

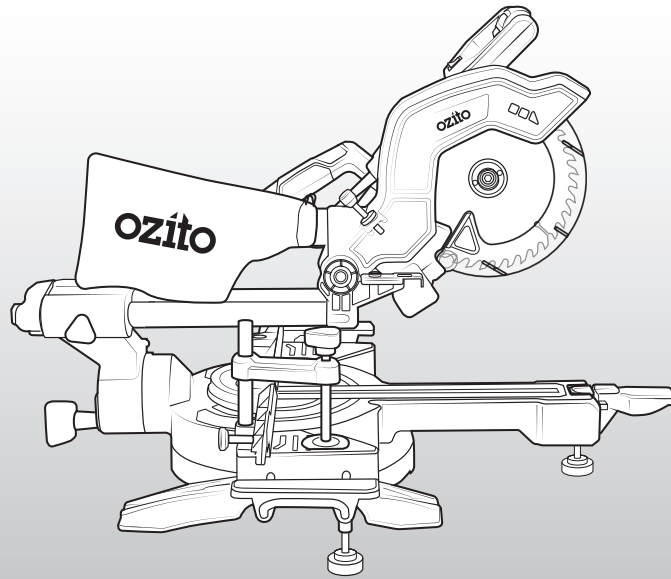

#### STANDARD EQUIPMENT

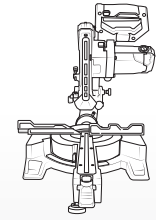

Sliding Compound Mitre Saw

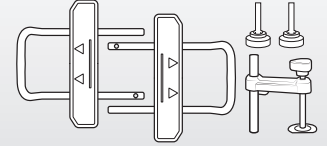

2 x Material Supports, 2 x Material Support Feet & Material Clamp



Dust Bag, 2 x Handle Screws, Carry Handle & Hex Key

# 3 YEAR REPLACEMENT WARRANTY

**SCMS-1621MS**

## WARRANTY

IN ORDER TO MAKE A CLAIM UNDER THIS WARRANTY YOU MUST RETURN THE PRODUCT TO YOUR NEAREST BUNNINGS WAREHOUSE WITH YOUR BUNNINGS REGISTER RECEIPT. PRIOR TO RETURNING YOUR PRODUCT FOR WARRANTY PLEASE TELEPHONE OUR CUSTOMER SERVICE HELPLINE:

**Australia 1800 069 486**

**New Zealand 0508 069 486**

TO ENSURE A SPEEDY RESPONSE PLEASE HAVE THE MODEL NUMBER AND DATE OF PURCHASE AVAILABLE. A CUSTOMER SERVICE REPRESENTATIVE WILL TAKE YOUR CALL AND ANSWER ANY QUESTIONS YOU MAY HAVE RELATING TO THE WARRANTY POLICY OR PROCEDURE.

The benefits provided under this warranty are in addition to other rights and remedies which are available to you at law. Our goods come with guarantees that cannot be excluded at law. You are entitled to a replacement or refund for a major failure and for compensation for any other reasonably foreseeable loss or damage. You are also entitled to have the goods repaired or replaced if the goods fail to be of acceptable quality and the failure does not amount to a major failure. Generally you will be responsible for all costs associated with a claim under this warranty, however, where you have suffered any additional direct loss as a result of a defective product you may be able to claim such expenses by contacting our customer service helpline above.

### 3 YEAR REPLACEMENT WARRANTY

Your product is guaranteed for a period of **36 months from the original date of purchase**. If a product is defective it will be replaced in accordance with the terms of this warranty. Warranty excludes consumable parts, for example: valve adapters and accessories.

### WARNING

**The following actions will result in the warranty being void.**

- If the tool has been operated on a supply voltage other than that specified on the tool.
- If the tool shows signs of damage or defects caused by or resulting from abuse, accidents or alterations.
- Failure to perform maintenance as set out within the instruction manual.
- If the tool is disassembled or tampered with in any way.
- Professional, industrial or high frequency use.

# KNOW YOUR PRODUCT

## SLIDING COMPOUND MITRE SAW

- |                    |                          |
|--------------------|--------------------------|
| 1. Lock-Off Button | 9. Mitre Angle Guide     |
| 2. On/Off Trigger  | 10. Support Rail         |
| 3. Spindle Lock    | 11. Support Foot         |
| 4. Motor Head      | 12. Material Support Bar |
| 5. Lock Down Pin   | 13. Upper Back Fence     |
| 6. Material Clamp  | 14. Bevel Angle Guide    |
| 7. Back Fence      | 15. Cutting Depth Screw  |
| 8. Mounting Holes  | 16. Laser Guide          |

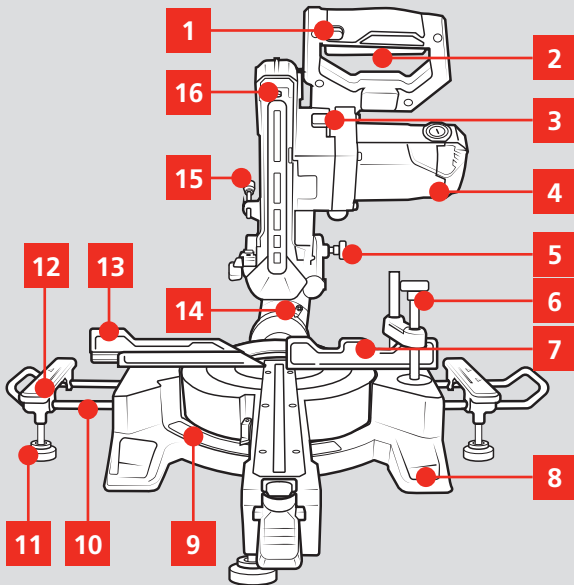

- |                         |                        |
|-------------------------|------------------------|
| 17. Slide Lock          | 24. Trenching Stop     |
| 18. Dust Bag            | 25. Mitre Lock         |
| 19. Carry Handle        | 26. Release Button     |
| 20. Laser Button        | 27. Table Insert       |
| 21. Cutting Head Handle | 28. Table Support Foot |
| 22. Blade Guard         | 29. Fence Screw        |
| 23. Saw Blade           | 30. Bevel Lock         |

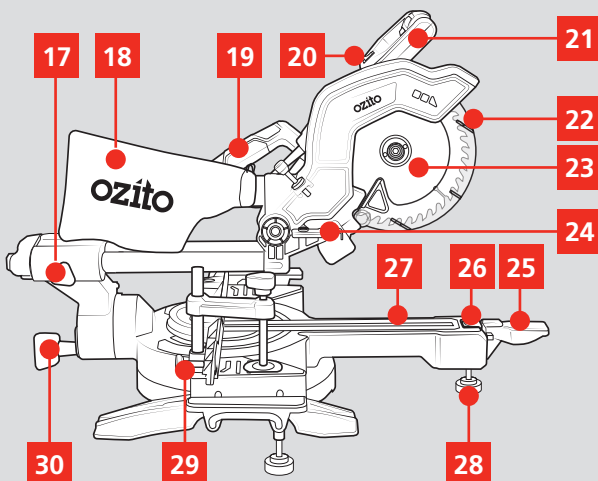

### ONLINE MANUAL

Scan this QR Code with your mobile device to take you to the online manual.



# SETUP & PREPARATION

## 1. ASSEMBLY

**WARNING!** ENSURE THE TOOL IS TURNED OFF AND DISCONNECTED FROM THE POWER SUPPLY BEFORE PERFORMING ANY OF THE FOLLOWING OPERATIONS.

### Attaching The Material Support Bars

1. On the underside of the saw, unwind the Phillips head screw, then insert the support rail into the side of the mitre saw base. Retighten the screw to hold it in place.

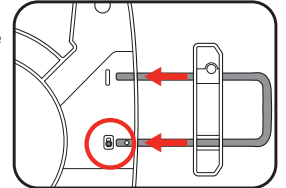

2. Attach a support foot to the material support bar.

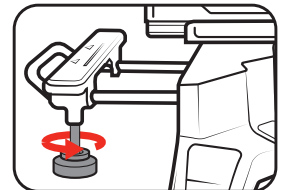

3. Repeat steps 1 and 2 on the other side of the mitre saw.

### Attaching The Dust Bag

1. Pinch the metal tabs together to widen the dust bag opening.
2. Slide it onto the dust extraction port and release the tabs to attach the dust bag.

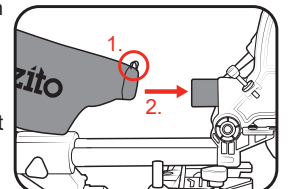

**Note:** The dust extraction port can block easily with dust and requires periodic cleaning. For more efficient operation, empty the dust bag when it is no more than half full. This allows better air flow through the bag.

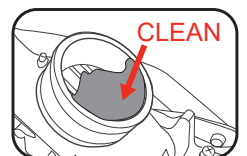

**Note:** Dust bags will not collect all the saw dust generated by the mitre saw. For best results use a vacuum for dust extraction by attaching a vacuum hose to the dust extraction port.

### Attaching The Carry Handle

1. Align the carry handle with the slot and use the provided screws to fasten it in place.

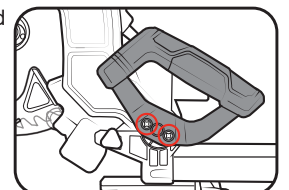

# 3 YEAR REPLACEMENT WARRANTY

## 2. SETUP & ADJUSTMENTS

### Material Supports

The material supports can be adjusted along the length of the support rails to suit the work piece.

If the mitre saw is not being used with a mitre saw stand, adjust the support screw until it rests firmly on the work surface. This will prevent the saw from tipping when working with long pieces of material.

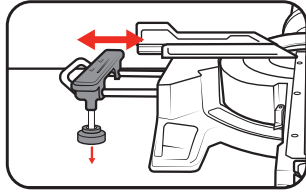

### Mitre Angle Adjustments

1. Flip the mitre lock upwards to unlock the mitre table.

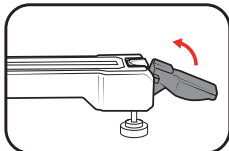

2. Hold down the release button and rotate the table to the desired mitre angle.

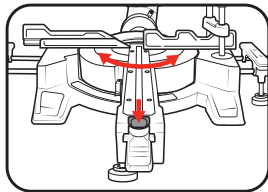

**Note:** The table has positive click stops at  $-45^\circ$ ,  $-30^\circ$ ,  $-22.5^\circ$ ,  $-15^\circ$ ,  $0^\circ$ ,  $15^\circ$ ,  $22.5^\circ$ ,  $30^\circ$ , and  $45^\circ$  for quick setting of common mitre angles.

3. Let go of the release button when the desired angle has been set.

4. Press down the mitre lock to secure the mitre table in place.

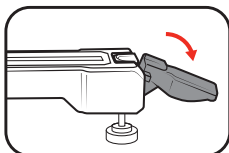

**WARNING!** ENSURE THE MITRE TABLE LOCK IS FULLY DEPRESSED BEFORE MAKING A CUT. FAILURE TO DO SO MAY RESULT IN THE MITRE TABLE MOVING DURING OPERATION & CAUSE SERIOUS PERSONAL INJURY.

5. Loosen the fence screw and slide the upper fence out of the way of the saw blade. Make sure that no part of the tool will come into contact with the upper fence during cutting.

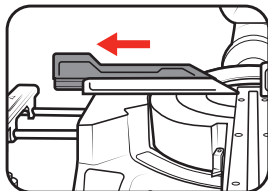

6. Retighten the fence screw to lock the fence in place.

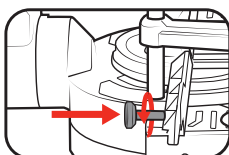

### Adjusting The Bevel Angle

1. Loosen the bevel lock.

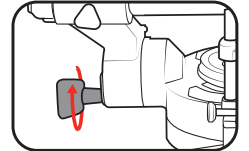

2. Tilt the cutting head to the desired bevel angle.

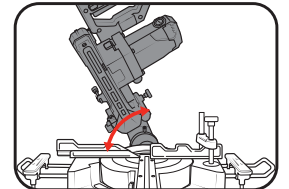

3. Tighten the bevel lock to secure the cutting head in position.

**WARNING!** ENSURE THE BEVEL LOCK IS FULLY TIGHTENED BEFORE MAKING A CUT. FAILURE TO DO SO MAY RESULT IN THE CUTTING HEAD MOVING UNEXPECTEDLY DURING OPERATION & CAUSE SERIOUS PERSONAL INJURY.

4. Loosen the fence screw and slide the upper fence out of the way of the saw blade. Make sure that no part of the tool will come into contact with the upper fence during cutting.

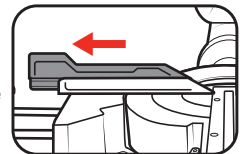

5. Retighten the fence screw to lock the fence in place.

### Trenching

This mitre saw is also able to cut trenches in work pieces by controlling the depth of cut.

**Note:** Before using the trenching function for the first time you will need to move the trenching stop into position. Loosen the trenching stop screw and slide the stop plate as far as possible towards the front of the saw. Then retighten the screw to lock it in place.

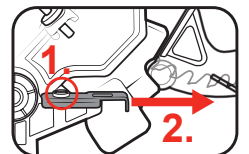

1. Loosen the lock nut.

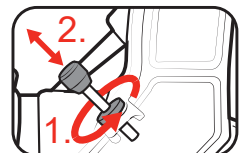

2. Rotate the cutting depth screw to set the desired trenching depth.

3. To check that the blade stops at the desired position, lower the cutting head until the cutting depth adjuster screw touches the trenching stop.

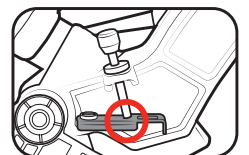

4. When the correct depth is set, retighten the lock nut.

**Note:** Always test the setting is correct on a scrap piece of wood before proceeding with your work piece.

### Material Clamp

Depending on the type of cut, the material clamp will need to be mounted on the appropriate side of the tool. When performing bevel cuts, the material clamp will need to be mounted on the right side of the saw.

1. Insert the metal pole into the slot on either side of the tool and tighten the pole screw to secure it.

2. Place the workpiece flat on the mitre table with one edge securely against the rear fence.

**Note:** If the workpiece is warped, ensure that the concave side is against the rear fence.

3. Tighten the clamp screw down onto the workpiece to hold it in place.

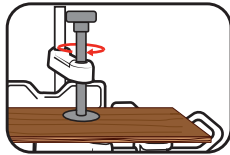
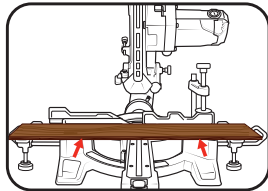
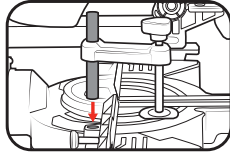
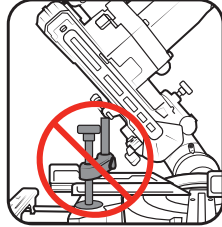

### Securing The Mitre Saw

The base of the saw has four mounting holes (1 in each corner) that can be used to mount it to a workbench or mitre saw stand. Use four appropriately sized bolts to secure it in place.

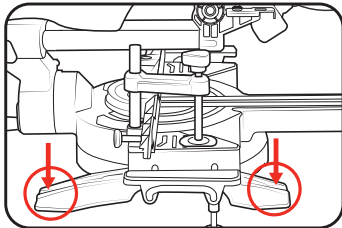

## 3. TYPES OF CUT



**WARNING!** DO NOT USE THE MITRE SAW TO CUT METAL OR MASONRY.

### Straight Cut

A straight cut is made by cutting the grain of the workpiece. A 90° straight cut is made with the mitre scale set in the 0°.

**Max. cutting capacity wood: 65 x 305mm**

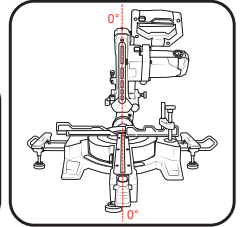
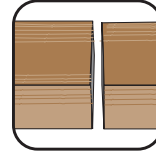

### Mitre Cut

Mitre cuts are made with the mitre scale set at an angle other than 0°.

**Max. cutting capacity wood: 65 x 215mm**

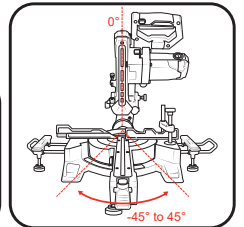
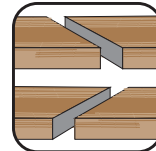

### Bevel Cut (Left)

A bevel cut is made by cutting across the grain of the workpiece with the blade angled to the mitre table.

**Max. cutting capacity wood: 33 x 305mm**

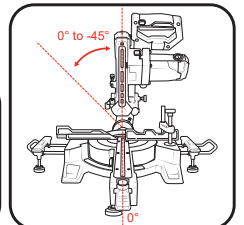
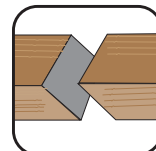

**WARNING!** ENSURE THE UPPER FENCE WILL NOT INTERFERE WITH THE CUTTING BLADE.

### Compound Mitre Cut

A compound mitre cut involves using a mitre angle and a bevel angle at the same time.

**Max. cutting capacity wood: 33 x 215mm**

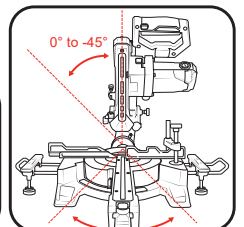
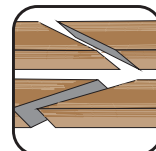

# OPERATION

## 4. CONTROLS

**WARNING!** THE TOOL IS RECOMMENDED FOR USE WITH A RESIDUAL CURRENT DEVICE WITH A RATED CURRENT OF 30mA OR LESS.

### Laser Guide

The laser guide helps with aligning workpieces for more accurate cuts.

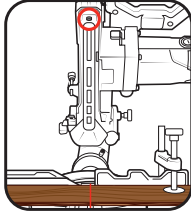

1. Press the laser button to the laser symbol to switch on the guide.
2. Press the laser button to the off '0' position to switch off the guide.

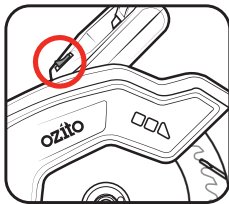

**Note:** Ensure that the laser guide is switched off when not in use.

### Starting The Saw

1. Press and hold the safety lock-off button.
2. Squeeze the on/off trigger to start the saw; you can then release the lock-off button.
3. Release the on/off trigger to stop the saw.

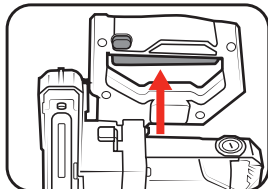
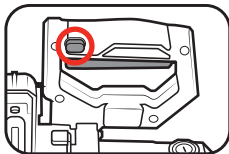

### Sliding Action

When cutting narrow pieces of wood it is not necessary to use the slide mechanism. Ensure the slide locking knob is tight to prevent the cutting head from sliding.

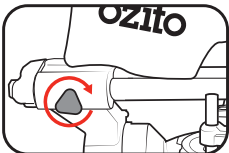

For workpieces wider than 100mm, the sliding action will need to be employed.

1. Loosen the slide lock.
2. Ensure that the cutting head is able to slide freely.

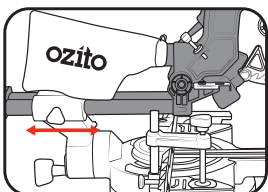

## 5. USAGE

**WARNING!** FOR ALL TYPES OF CUTS, ENSURE THAT ALL SETTINGS ON THE SAW ARE LOCKED INTO POSITION.

### Operating The Saw

1. Ensure that the workpiece is securely clamped down.
2. Start up the saw and allow the blade to come up to speed.

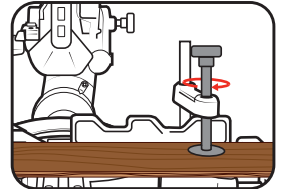

**WARNING!** BEFORE PERFORMING A CUT, ENSURE THAT THE BLADE IS AT FULL SPEED. FAILURE TO DO SO MAY CAUSE THE BLADE TO LOCK UP AND/OR BECOME BLUNT.

3. If the slide action has been disabled, lower the cutting head steadily until the saw blade has completely cut through the workpiece.

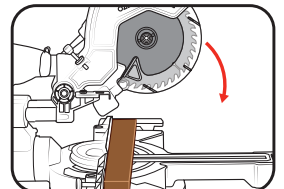

If the slide action is employed, lower the cutting head fully against the mitre table and then push the cutting head backwards until it cuts completely through the material.

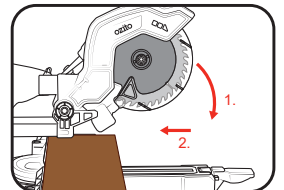

**Note:** The blade guard will automatically retract to expose the saw blade as the cutting head is lowered.

4. Release the on/off trigger and allow the saw blade to come to a complete stop before raising the cutting head back to its' original position.

**Note:** Do not suddenly release the cutting head as the springs will cause it to bounce up. Guide it back into the raised position by applying slight counter-pressure against the springs.



# MAINTENANCE

## 6. TROUBLESHOOTING

Symptom	Possible Cause	Suggested Solution
Mitre saw will not start.	No power at power point.	Check that the power switch is on.
	Cord not connected.	Check that the cord is plugged in.
Mitre saw operates sporadically or at low power.	Low power supply or improper extension cord.	Inspect power supply or power cords.
	Worn or cracked carbon brushes.	Inspect carbon brushes; replace if damaged or worn.
Wood burns at ends of cut	Dirty blade.	Clean blade using blade cleaner or mineral spirits.
	Material is binding.	Check position of workpiece on table. Material must be flat, flush against fence & supported on ends.
Workpiece frays or chips out.	Finished side is down.	Keep finished side of workpiece up or facing operator.
	Blade chipped or dull.	Check for damaged teeth. Sharpen or replace blade.
	Blade inappropriate for material.	Check blade manufacturer's recommendations for material being cut. For cross cutting hardwood & for precision cuts, use a thin kerf blade with 60 or more teeth.
	Workpiece is unsupported.	Use a thin piece of scrap material, such as 6mm plywood underneath or behind the workpiece to support the edges of the workpiece as it is being cut.
Blade binds, slowing or stopping the saw.	Workpiece is misaligned or the ends are not supported.	Workpiece must be flat on table, flush against the fence & supported on both ends.
	Workpiece is wet, contaminated or inappropriate blade is being used.	Check condition of workpiece & check compatibility of blade to workpiece.
Blade does not cut completely through workpiece.	Depth stop setting in use.	Move depth stop to right to disengage.
	Depth stop set too shallow.	Adjust depth stop bolt for desired depth of cut.



**WARNING!** BEFORE CLEANING THE TOOL OR CARRYING OUT ANY MAINTENANCE PROCEDURE, MAKE SURE THAT IT IS DISCONNECTED FROM THE POWER SUPPLY TO PREVENT ACCIDENTAL STARTING.

### Cleaning

1. We recommend that you clean the appliance immediately after you use it.
2. Keep the safety devices free of dirt and dust as much as possible. Wipe the equipment with a clean cloth.
3. Clean the appliance regularly with a damp cloth and some soft soap. Do not use cleaning agents or solvents; these may be aggressive to the plastic parts in the appliance. Ensure that no water can get into the interior of the appliance.

### Storage & Transport

Pull the mains plug out of the socket, switch off the tool and make sure that it is secured in such a way that it cannot be started up again by any unauthorised person. Store the tool in a dry location which is not accessible to unauthorised persons.

Lower the cutting head and push the lock down pin in to secure it before transport or storage. The saw must never be used with the lock down pin locking the head down.

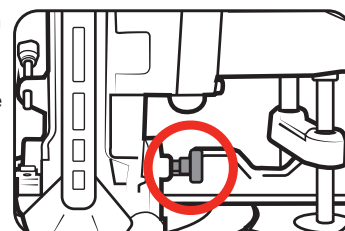

Tighten the slide lock before transportation.

### Carbon Brushes

When the carbon brushes wear out, the mitre saw will spark and/or stop. Discontinue use as soon as this happens. They should be replaced prior to recommencing use of the mitre saw. Carbon brushes are a wearing component of the mitre saw therefore not covered under warranty. Continuing to use the mitre saw when carbon brushes need to be replaced may cause permanent damage to the mitre saw. Carbon brushes will wear out after many uses but when the carbon brushes need to be replaced, take the mitre saw to an electrician or a power tool repairer for a quick and low cost replacement. Always replace both carbon brushes at the same time.



A small amount of sparking may be visible through the housing vents. This is normal and does not indicate a problem.

### Supply Cords

If replacement of the supply cord is necessary, this has to be done by a certified electrician in order to avoid a safety hazard.

**Note:** Ozito Industries will not be responsible for any damage or injuries caused by the repair of the tool by an unauthorised person or by mishandling of the tool.

## Changing The Blade

1. Ensure the plug is disconnected from the mains power supply. Ensure the cutting head is raised; if it's lowered in place, pull the lock down pin and gently raise the cutting head.

**WARNING!** WEAR GLOVES WHEN CHANGING THE BLADE.

2. Place the 6mm Hex Key onto the blade bolt in the centre of the blade.

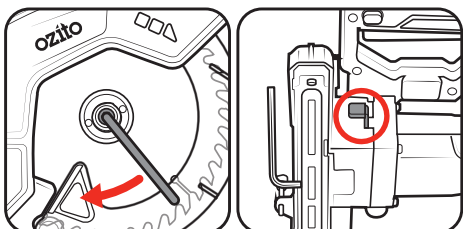

3. Depress the spindle lock button to hold the blade in place.

To ensure it engages correctly, rotate the Hex Key until the spindle lock clicks into position.

4. Loosen the bolt in the centre of the blade by turning the Hex Key clockwise as the blade bolt is a left hand thread.

5. Remove the blade bolt and outer flange.

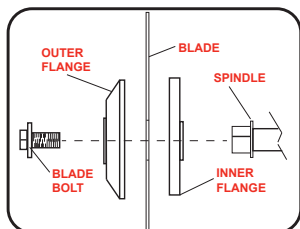

6. Swing the blade guard out of the way and remove the blade from the spindle. Make sure the inner flange stays in place on the spindle.

**Note:** Use a rubber mallet to tap the blade off if it is stuck on the tool.

**WARNING!** NEVER USE A BLADE THAT IS LARGER THAN THE STATED CAPACITY OF THE MITRE SAW. IT MIGHT COME INTO CONTACT WITH THE BLADE GUARD & RISK PERSONAL INJURY OR DAMAGE TO THE SAW. THIS IS NOT COVERED UNDER THE WARRANTY

**WARNING!** NEVER USE A BLADE THAT IS TOO THICK TO ALLOW THE OUTER BLADE WASHER TO ENGAGE WITH THE FLATS ON THE SPINDLE. IT WILL PREVENT THE BLADE SCREW FROM PROPERLY SECURING THE BLADE ONTO THE SPINDLE.

**WARNING!** ENSURE THAT THE BLADE BUSH (IF REQUIRED) SUITS THE SPINDLE AND BLADE THAT IS FITTED.

**WARNING!** ENSURE THAT THE ARROW DIRECTION ON THE BLADE CORRESPONDS WITH THE ARROW ON THE UPPER BLADE GUARD. THE TEETH SHOULD POINT DOWNWARDS.

7. Install the new blade over the spindle and onto the inner flange.
8. Replace the outer flange by placing the cupped side of the flange against the blade followed by the washer and then blade bolt.
9. Place the 6mm Hex Key provided onto the blade bolt in the centre of the blade.
10. Depress the spindle lock button. To ensure it engages correctly, rotate the Hex Key until the spindle lock clicks into position.
11. Tighten the blade bolt in the centre of the blade by turning the Hex Key anti-clockwise as the blade bolt is a left hand thread.
12. Make sure the blade guard operates smoothly and properly protects from the blade before using the saw.

## DESCRIPTION OF SYMBOLS

<b>V</b>	Volts	<b>Hz</b>	Hertz
<b>~</b>	Alternating Current	<b>W</b>	Watts
<b>/min</b>	Revolutions or reciprocations per minute	<b>n<sub>0</sub></b>	No load speed
	Wear eye, ear & breathing protection		Double insulated
	Wear gloves		Laser! Do not stare into beam
	Regulatory Compliance Mark (RCM)		Warning
	Read Instruction Manual		Warning! Risk of injury! Do not reach into the running saw blade

## CARING FOR THE ENVIRONMENT



Power tools that are no longer usable should not be disposed of with household waste but in an environmentally friendly way. Please recycle where facilities exist. Check with your local council authority for recycling advice.



Recycling packaging reduces the need for landfill and raw materials. Reuse of recycled material decreases pollution in the environment. Please recycle packaging where facilities exist. Check with your local council authority for recycling advice.

## SPARE PARTS

Spare parts can be ordered from the Special Orders Desk at your local Bunnings Warehouse.

For further information, or any parts not listed here, visit [www.ozito.com.au](http://www.ozito.com.au) or contact Ozito Customer Service:

Australia 1800 069 486

New Zealand 0508 069 486

E-mail: [enquiries@ozito.com.au](mailto:enquiries@ozito.com.au)

# ELECTRICAL SAFETY

 **WARNING!** When using mains-powered tools, basic safety precautions, including the following, should always be followed to reduce risk of fire, electric shock, personal injury and material damage.

Read the whole manual carefully and make sure you know how to switch the tool off in an emergency, before operating the tool.

Save these instructions and other documents supplied with this tool for future reference.

The charger has been designed for 230V and 240V only. Always check that the power supply corresponds to the voltage on the rating plate.

**Note:** The supply of 230V and 240V on Ozito tools are interchangeable for Australia and New Zealand.

**This tool is double insulated; therefore no earth wire is required.**



**Note:** Double insulation does not take the place of normal safety precautions when operating this tool. The insulation system is for added protection against injury resulting from a possible electrical insulation failure within the tool.

If the supply cord is damaged, it must be replaced by an electrician or a power tool repairer in order to avoid a hazard.

## Using an Extension Lead

Always use an approved extension lead suitable for the power input of this tool. Before use, inspect the extension lead for signs of damage, wear and ageing. Replace the extension lead if damaged or defective. When using an extension lead on a reel, always unwind the lead completely. Use of an extension lead not suitable for the power input of the tool or which is damaged or defective may result in a risk of fire and electric shock.

The power supply for this product's charger should be protected by a residual current device (rated at 30mA or less). A residual current device reduces the risk of electric shock.

# GENERAL POWER TOOL SAFETY WARNINGS

 **WARNING!** Read all safety warnings and all instructions. Failure to follow the warnings and instructions may result in electric shock, fire and/or serious injury.

Save all warnings and instructions for future reference. The term "power tool" in the warnings refers to your mains-operated (corded) power tool or battery-operated (cordless) power tool.

1. Work area safety

**a. Keep work area clean and well lit.** Cluttered or dark areas invite accidents.

**b. Do not operate power tools in explosive atmospheres, such as in the presence of flammable liquids, gases or dust.** Power tools create sparks which may ignite the dust or fumes.

**c. Keep children and bystanders away while operating a power tool.** Distractions can cause you to lose control.

2. Electrical safety

**a. Power tool plugs must match the outlet. Never modify the plug in any way. Do not use any adapter plugs with earthed (grounded) power tools.** Unmodified plugs and matching outlets will reduce risk of electric shock.

**b. Avoid body contact with earthed or grounded surfaces, such as pipes, radiators, ranges and refrigerators.** There is an increased risk of electric shock if your body is earthed or grounded.

**c. Do not expose power tools to rain or wet conditions.** Water entering a power tool will increase the risk of electric shock.

**d. Do not abuse the cord. Never use the cord for carrying, pulling or unplugging the power tool. Keep cord away from heat, oil, sharp edges or moving parts.** Damaged or entangled cords increase the risk of electric shock.

**e. When operating a power tool outdoors, use an extension cord suitable for outdoor use.** Use of a cord suitable for outdoor use reduces the risk of electric shock.

3. Personal safety

**a. Stay alert, watch what you are doing and use common sense when operating a power tool. Do not use a power tool while you are tired or under the influence of drugs, alcohol or medication.** A moment of inattention while operating power tools may result in serious personal injury.

**b. Use personal protective equipment. Always wear eye protection.** Protective equipment such as dust mask, non-skid safety shoes, hard hat, or hearing protection used for appropriate conditions will reduce personal injuries.

**c. Prevent unintentional starting. Ensure the switch is in the off-position before connecting to power source and/or battery pack, picking up or carrying the tool. Carrying power tools with your finger on the switch or energising power tools that have the switch on invites accidents.**

**d. Remove any adjusting key or wrench before turning the power tool on.** A wrench or a key left attached to a rotating part of the power tool may result in personal injury.

**e. Do not overreach. Keep proper footing and balance at all times.** This enables better control of the power tool in unexpected situations.

**f. Dress properly. Do not wear loose clothing or jewellery. Keep your hair, clothing and gloves away from moving parts.** Loose clothes, jewellery or long hair can be caught in moving parts.

**g. If devices are provided for the connection of dust extraction and collection facilities, ensure these are connected and properly used.** Use of dust collection can reduce dust-related hazards.

**h. Do not let familiarity gained from frequent use of tools allow you to become complacent and ignore tool safety principles.** A careless action can cause severe injury within a fraction of a second.

4. Power tool use and care

**a. Do not force the power tool. Use the correct power tool for your application.** The correct power tool will do the job better and safer at the rate for which it was designed.

**b. Do not use the power tool if the switch does not turn it on and off.** Any power tool that cannot be controlled with the switch is dangerous and must be repaired.

**c. Disconnect the plug from the power source and/or the battery pack from the power tool before making any adjustments, changing accessories, or storing power tools.** Such preventive safety measures reduce the risk of starting the power tool accidentally.

**d. Store idle power tools out of the reach of children and do not allow persons unfamiliar with the power tool or these instructions to operate the power tool.** Power tools are dangerous in the hands of untrained users.

**e. Maintain power tools.** Check for misalignment or binding of moving parts, breakage of parts and any other condition that may affect the power tool's operation. If damaged, have the power tool repaired before use. Many accidents are caused by poorly maintained power tools.

**f. Keep cutting tools sharp and clean.** Properly maintained cutting tools with sharp cutting edges are less likely to bind and are easier to control.

**g. Use the power tool, accessories and tool bits etc. in accordance with these instructions, taking into account the working conditions and the work to be performed.** Use of the power tool for operations different from those intended could result in a hazardous situation.

**h. Keep handles and grasping surfaces dry, clean and free from oil and grease.** Slippery handles and grasping surfaces do not allow for safe handling and control of the tool in unexpected situations.

5. Service

**a. Have your power tool serviced by a qualified repair person using only identical replacement parts.** This will ensure that the safety of the power tool is maintained.

# MITRE SAW SAFETY WARNINGS

 **The appliance is not to be used by persons (including children) with reduced physical, sensory or mental capabilities, or lack of experience and knowledge, unless they have been given supervision or instruction.**

**Young children should be supervised to ensure that they do not play with the appliance.**

**WARNING!** Before connecting a tool to a power source (mains switch power point receptacle, outlet, etc.) be sure that the voltage supply is the same as that specified on the nameplate of the tool. A power source with a voltage greater than that specified for the tool can result in serious injury to the user, as well as damage to the tool. If in doubt, do not plug in the tool. Using a power source with a voltage less than the nameplate rating is harmful to the motor.

- Your tool is double insulated for additional protection against a possible electrical insulation failure within the tool.
- Always remove the plug from the mains socket before making any adjustments or maintenance, including changing the blade.
- When operating the saw, use safety equipment including safety goggles or shield, ear protection, dust mask and protective clothing including safety gloves.
- Ensure that there is adequate general or localised lighting.
- Do not use the saw unless the guards are in place.
- Do not use the saw to cut metal or masonry.
- Do not let anyone under 18 years operate this saw.
- Ensure that the operator is adequately trained in the use, adjustment and operation of the machine.
- Do not use this saw to cut firewood.
- Keep the area free of tripping hazards.
- Report faults in the machine, including guards and saw blades, as soon as they are discovered.
- Ensure that the machine is always fixed to a bench, whenever possible.
- Always stand to one side when operating the saw.
- Never use a cracked or distorted saw blade.
- When cutting round wood, use clamps that prevent the workpiece from turning on both sides of the blade.
- Never use your hands to remove sawdust, chips or waste close by the blade.
- Do not use blades of High Speed Steel (HSS blades).
- If the table insert is damaged or worn, have it replaced by a power tool repairer.
- Rags, cloths, cord and string and the like should never be left around the work area.
- Avoid cutting nails. Inspect the workpiece and remove all nails and other foreign objects before operating the saw.
- Support the work properly.
- Refrain from removing any cut-offs or other parts of the workpiece from the cutting area whilst the machine is running and the saw head is not in the rest position.

- Do not attempt to free a jammed blade before first switching off the machine.
- Do not slow or stop a blade with a piece of wood. Let the blade come to rest without assistance.
- If you are interrupted when operating the saw, complete the process and switch off before looking up.
- Periodically check that all nuts, bolts and other fixings are properly tightened.
- Do not store materials or equipment above a machine in such a way that they could fall into it.
- Always hold the saw on parts that are insulated. If you accidentally cut into hidden wiring or the saw's own cable, the metal parts of the saw will become "live". Switch off at the mains and remove the plug immediately.
- Never saw near combustible liquids or gases.
- Note the direction of rotation of the motor and the blade.
- Do not lock the movable guard in the open position and always ensure that it is working properly, freely rotating and returning to fully cover the teeth of the blade.
- Connect the saw to a dust collection device and ensure that it is operating properly. As the operator of the saw, please make sure that you understand factors that influence exposure to dust, including the type of material to be cut, the importance of local extraction and the proper adjustment of hoods/baffles/chutes of your dust extraction system. We recommend that you always wear a dust mask when operating this saw.
- Wear gloves when handling saw blades and rough materials.
- Saw blades shall be carried in a holder wherever possible.
- Select saw blades in relation to the material being cut.
- Use correctly sharpened saw blades and observe the maximum speed marked on the blade.
- Take additional care when trenching (slotting).
- The mitre saw can be safely carried by the carrying handle but only once it has been removed from the mains power and secured in the locked down position.
- Ensure that the arm is properly secure when bevelling.
- Keep the floor area around the machine level, well maintained and free of loose materials.
- Ensure that you are trained in the use, adjustment and operation of the machine.
- Do not remove any cut-offs from the cutting area until the mitre saw head is in the full upright position, the blade guard is fully enclosing the blade and the blade has come to a rest or complete stop.
- When cutting long pieces which extend well over the table width, ensure that the ends are adequately supported at the same height as the saw table top. Supports should be positioned in such a way to ensure that the workpiece does not fall to the ground once the cut has been made.
- A number of supports at regular intervals may be required if the workpiece is extremely long.
- Keep hands away from moving parts.
- Operating Mitre Saws without the correct hearing protection may result in impairment of hearing.
  - Wear goggles
  - Wear earmuffs
  - Wear a breathing mask



# ozito

## MITRE SAW STAND

**150kg 1950mm**

### INSTRUCTION MANUAL

#### SPECIFICATIONS

Folded Size:	940 x 545 x 810mm
Length:	940mm (Folded) 1950mm (Extended)
Height:	810mm (Folded) 920mm (Extended)
Loading Capacity:	150kg
Weight:	9.65kg

[ozito.com.au](http://ozito.com.au)

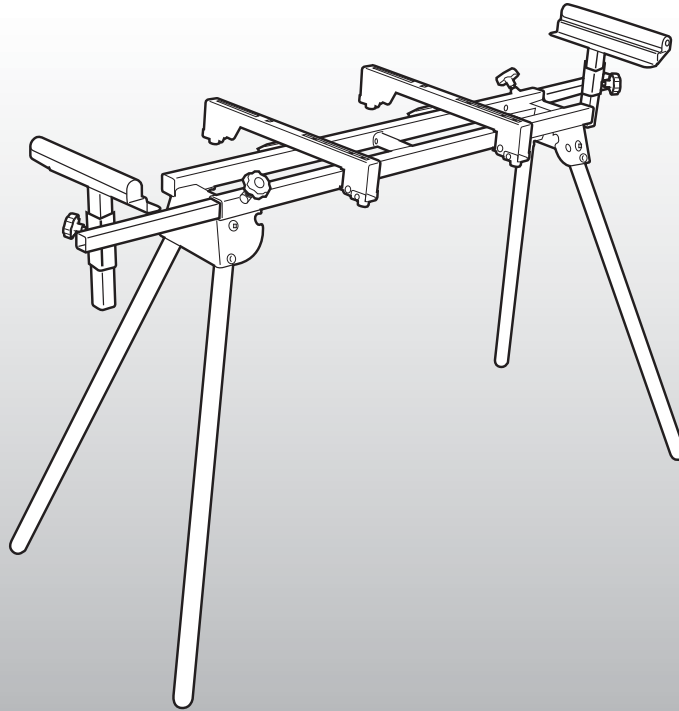

#### STANDARD EQUIPMENT

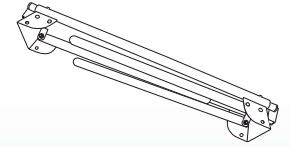

Mitre Saw Stand

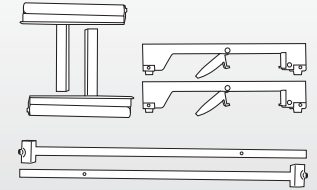

2 x Roller Arms, 2 x Mounting Bars, & 2 x Extension Arms



4 x Fastening Knobs

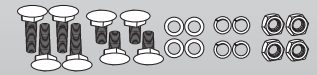

4 x 60mm bolts, 4 x 35mm bolts,  
4 x Washers, 4 x Spring Washers,  
& 4 x Hex Nuts

# 3 YEAR REPLACEMENT WARRANTY

**SCMS-1621MS**

## WARRANTY

IN ORDER TO MAKE A CLAIM UNDER THIS WARRANTY YOU MUST RETURN THE PRODUCT TO YOUR NEAREST BUNNINGS WAREHOUSE WITH YOUR BUNNINGS REGISTER RECEIPT. PRIOR TO RETURNING YOUR PRODUCT FOR WARRANTY PLEASE TELEPHONE OUR CUSTOMER SERVICE HELPLINE:

**Australia 1800 069 486**

**New Zealand 0508 069 486**

TO ENSURE A SPEEDY RESPONSE PLEASE HAVE THE MODEL NUMBER AND DATE OF PURCHASE AVAILABLE. A CUSTOMER SERVICE REPRESENTATIVE WILL TAKE YOUR CALL AND ANSWER ANY QUESTIONS YOU MAY HAVE RELATING TO THE WARRANTY POLICY OR PROCEDURE.

The benefits provided under this warranty are in addition to other rights and remedies which are available to you at law. Our goods come with guarantees that cannot be excluded at law. You are entitled to a replacement or refund for a major failure and for compensation for any other reasonably foreseeable loss or damage. You are also entitled to have the goods repaired or replaced if the goods fail to be of acceptable quality and the failure does not amount to a major failure.

Generally you will be responsible for all costs associated with a claim under this warranty, however, where you have suffered any additional direct loss as a result of a defective product you may be able to claim such expenses by contacting our customer service helpline above.

### 3 YEAR REPLACEMENT WARRANTY

Your product is guaranteed for a period of **36 months from the original date of purchase**. If a product is defective it will be replaced in accordance with the terms of this warranty. Warranty excludes consumable parts, for example: valve adapters and accessories.

### WARNING

**The following actions will result in the warranty being void.**

- If the tool has been operated on a supply voltage other than that specified on the tool.
- If the tool shows signs of damage or defects caused by or resulting from abuse, accidents or alterations.
- Failure to perform maintenance as set out within the instruction manual.
- If the tool is disassembled or tampered with in any way.
- Professional, industrial or high frequency use.

# KNOW YOUR PRODUCT

## MITRE SAW STAND

- |                              |                                  |
|------------------------------|----------------------------------|
| 1. Mounting Bar              | 8. Stand Leg                     |
| 2. Fastening Slot            | 9. Frame                         |
| 3. Mounting Bar Handle       | 10. Extension Arm Fastening Knob |
| 4. Extension Arm Locking Pin | 11. Lower Leg Locking Pin        |
| 5. Roller                    | 12. Extension Arm                |
| 6. Material Support Shelf    | 13. Roller Arm                   |
| 7. Upper Leg Locking Pin     | 14. Roller Arm Fastening Knob    |

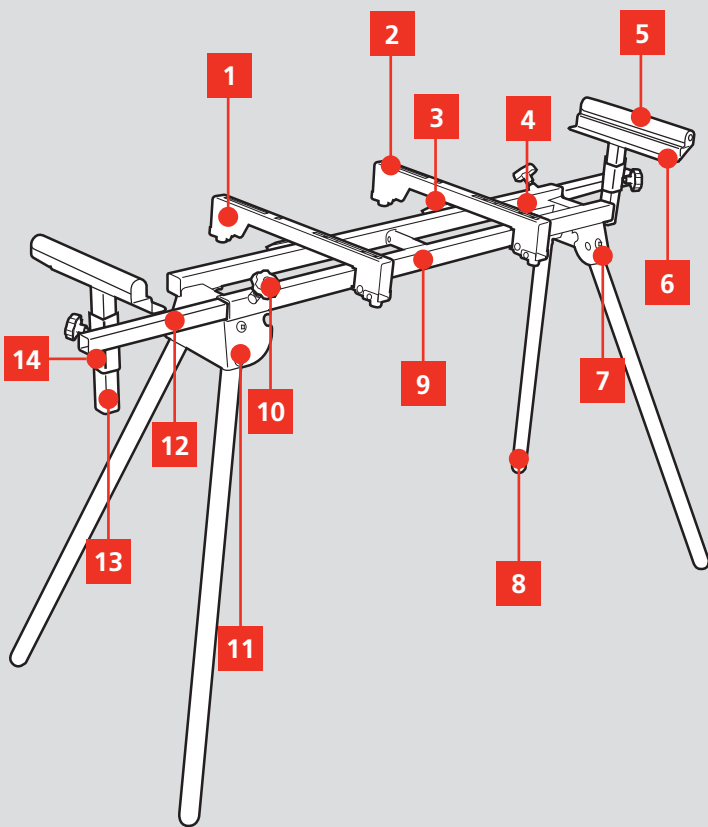

### ONLINE MANUAL

Scan this QR Code with your mobile device to take you to the online manual.



# SETUP & PREPARATION

## 1. ASSEMBLY



**WARNING!** THIS STAND IS INTENDED FOR USE WITH MITRE SAWS ONLY. DO NOT USE AS A STEP LADDER, STEPPING STOOL, STORAGE RACK, ETC. OZITO WILL NOT BE LIABLE FOR DAMAGE OR INJURY CAUSE BY IMPROPER USE OF THIS UNIT.

### Unfolding The Stand

1. Lay the mitre saw stand on the floor with the folded legs facing up.

2. Depress the leg locking button and unfold the 2 upper legs until the locking button clicks into place.

3. Repeat the same procedure for the other 2 legs.

4. Lift the stand and flip it into the upright position.

5. Check that the stand is stable and all of the leg locking buttons have engaged properly.

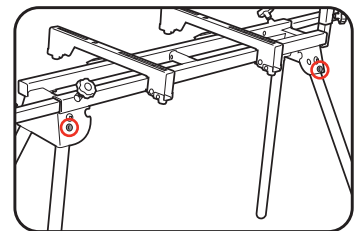
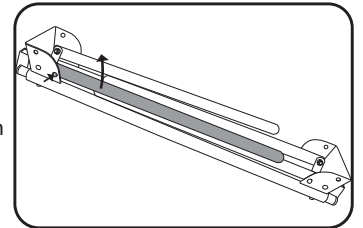

### Folding The Stand

1 pair of legs on the stand must fold in first for the stand to fold flat. The legs have not folded into place if the leg locking button does not pop into place. The legs should not swing about when the stand is picked up if the legs have locked into position.

1. Turn the mitre saw upside down on the floor with the legs sticking up.

2. Depress the leg locking buttons on the lower pair of legs and fold them in.

3. Repeat the same procedure on the other pair of legs.

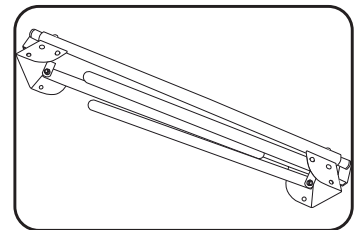

**WARNING!** KEEP HANDS AWAY FROM MOVING PARTS.

**3** YEAR REPLACEMENT WARRANTY

### Attaching The Extension Arms

1. Slide the extension arms into the frame.

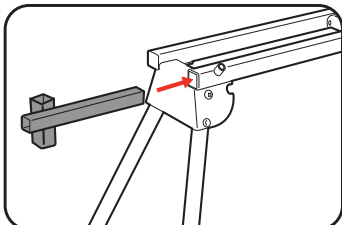

**Note:** The locking pin on the extension arms should be facing inwards towards the centreline of the stand. You will need to depress this twice (once when the locking pin reaches the frame and again when it pops through the locating hole further in).

2. Continue sliding the extension arm into the frame until the desired length is reached.

3. Insert a fastening knob into the hole on the frame turn it clockwise to secure the extension arm in place.

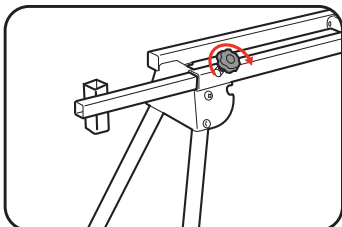

4. Insert a roller arm into the collar on the extension arm. The material support shelf should be facing inwards towards the centre of the stand.

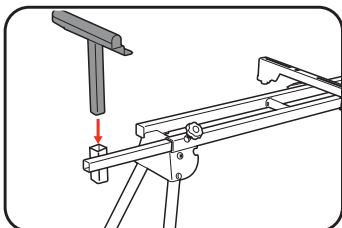

5. Insert a fastening knob into the bracket and turn it clockwise to tighten the roller arm into place.

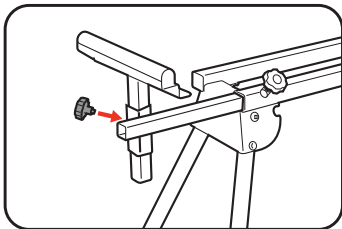

6. Repeat the same procedure with the opposite extension arm.

### Attaching The Mitre Saw Mounts

1. Depress the mounting bar handles and hook the opposite end of the mount onto the frame of the stand.

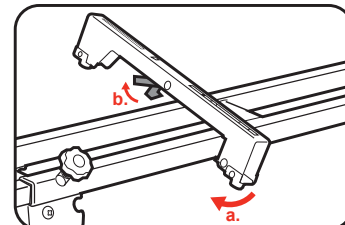

2. Lower the handles onto the frame and release them to lock the mounting bar into place.

3. Repeat the same procedure with the other mounting bar.

# OPERATION

## 2. ATTACHING A MITRE SAW

**WARNING!** ONLY USE A MITRE SAW THAT HAS 4 FIXING HOLES (1 IN EACH CORNER OF THE BASE) ON THIS STAND, AS OTHERWISE IT CANNOT BE PROPERLY SECURED. FAILURE TO FOLLOW THIS DIRECTION MAY RESULT IN DAMAGE TO PROPERTY AND/OR PERSONAL INJURY.

### Fastening The Mitre Saw

This unit comes with 4 x 35mm bolts and 4 x 60mm bolts. Either set may be used to fasten the mitre saw.

1. Adjust the mounting bars to roughly the width of the mitre saw base.

2. Place the mitre saw on the mounting bars and line up the holes in the mitre saw base with the slots on the mounting bars.

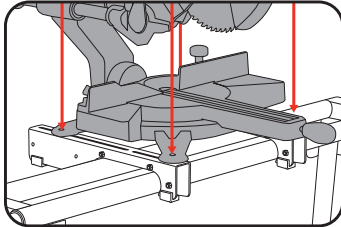

3. Feed a bolt through the bottom of the mounting bar then through the base of the mitre saw.

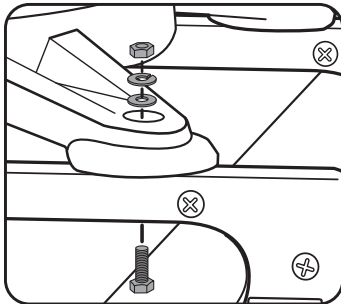

4. Slide a washer and then a spring washer onto the bolt and fasten it with a hex nut.

5. Repeat steps 3 and 4 for the other 3 holes on the mitre saw base.

**WARNING!** DURING OPERATION AND BEFORE STARTING A NEW JOB, ENSURE THAT ALL SCREWS AND NUTS ARE TIGHTENED CORRECTLY AND SECURELY.

## 3. ADJUSTMENTS

### Adjusting The Extension Arms

1. Turn the fastening knob on the frame counter-clockwise to loosen it.

2. Pull the extension arm out to the desired length.

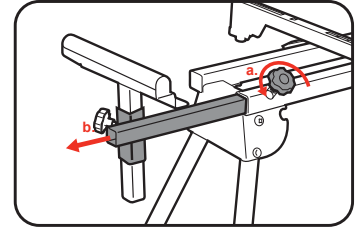

**Note:** The maximum extension length is reached when the arm locking pin clicks into place. To shorten the extension arm again, depress this pin and push the extension arm back into the frame.

3. Turn the fastening knob clockwise to tighten it and secure the extension arm into place.

### Adjusting The Roller Height

1. Turn the fastening knob on the collar of the extension arm counter-clockwise to loosen it.

2. Raise or lower the roller to the desired height.

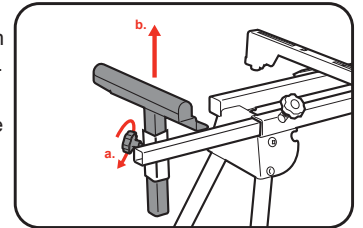

3. Turn the fastening knob clockwise to tighten it and secure the roller into place.

### Using The Material Support Shelves

The mitre saw stand features material support shelves which allow repetitive cuts to be made quickly and accurately.

1. Adjust the height of the roller arm so that the lip of the material support shelf is in line with the work surface of the mitre saw.

2. Adjust the extension arms to the desired cutting length.

3. Place the end of the workpiece against the material support shelf and commence the cut.

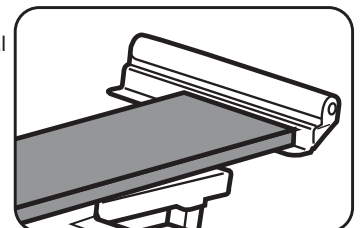

# MAINTENANCE

## 6. APPLIANCE CARE



**WARNING!** BEFORE CLEANING OR CARRYING OUT ANY MAINTENANCE PROCEDURE, MAKE SURE THAT ANY MOUNTED POWER TOOL IS DISCONNECTED FROM THE POWER SUPPLY TO PREVENT ACCIDENTAL STARTING.

### Cleaning

1. Wipe away dirt and dust from the Mitre Saw Stand on a regular basis.

### Storage

The Mitre Saw Stand can be easily folded for convenient storage and transportation. Detach the mitre saw before storage or transporting the mitre saw stand.

Follow the leg assembly instructions in reverse to fold up the Mitre Saw Stand.

**Note:** When transporting the Mitre Saw Stand in a vehicle, always tie it down to prevent movement and possible damage.

**Note:** Ozito will not be responsible for any damage or injuries caused by the repair of the tool by an unauthorised person or by mishandling of the tool.

# DESCRIPTION OF SYMBOLS

	Warning		Wear eye, ear & breathing protection
	Read instruction manual		

# CARING FOR THE ENVIRONMENT



Power tools that are no longer usable should not be disposed of with household waste but in an environmentally friendly way. Please recycle where facilities exist. Check with your local council authority for recycling advice.



Recycling packaging reduces the need for landfill and raw materials. Reuse of recycled material decreases pollution in the environment. Please recycle packaging where facilities exist. Check with your local council authority for recycling advice.

# SPARE PARTS

Spare parts can be ordered from the Special Orders Desk at your local Bunnings Warehouse.

For further information, or any parts not listed here, visit [www.ozito.com.au](http://www.ozito.com.au) or contact Ozito Customer Service:

Australia 1800 069 486

New Zealand 0508 069 486

E-mail: [enquiries@ozito.com.au](mailto:enquiries@ozito.com.au)



# GENERAL POWER TOOL SAFETY WARNINGS



**WARNING!** Read all safety warnings and all instructions. Failure to follow the warnings and instructions may result in electric shock, fire and/or serious injury.

Save all warnings and instructions for future reference. The term "power tool" in the warnings refers to your mains-operated (corded) power tool or battery-operated (cordless) power tool.

## 1. Work area safety

- a. **Keep work area clean and well lit.** Cluttered or dark areas invite accidents.
  - b. **Do not operate power tools in explosive atmospheres, such as in the presence of flammable liquids, gases or dust.** Power tools create sparks which may ignite the dust or fumes.
  - c. **Keep children and bystanders away while operating a power tool.** Distractions can cause you to lose control.
- ## 2. Electrical safety
- a. **Power tool plugs must match the outlet. Never modify the plug in any way. Do not use any adapter plugs with earthed (grounded) power tools.** Unmodified plugs and matching outlets will reduce risk of electric shock.
  - b. **Avoid body contact with earthed or grounded surfaces, such as pipes, radiators, ranges and refrigerators.** There is an increased risk of electric shock if your body is earthed or grounded.
  - c. **Do not expose power tools to rain or wet conditions.** Water entering a power tool will increase the risk of electric shock.
  - d. **Do not abuse the cord. Never use the cord for carrying, pulling or unplugging the power tool. Keep cord away from heat, oil, sharp edges or moving parts.** Damaged or entangled cords increase the risk of electric shock.
  - e. **When operating a power tool outdoors, use an extension cord suitable for outdoor use.** Use of a cord suitable for outdoor use reduces the risk of electric shock.

## 3. Personal safety

- a. **Stay alert, watch what you are doing and use common sense when operating a power tool. Do not use a power tool while you are tired or under the influence of drugs, alcohol or medication.** A moment of inattention while operating power tools may result in serious personal injury.
- b. **Use personal protective equipment. Always wear eye protection.** Protective equipment such as dust mask, non-skid safety shoes, hard hat, or hearing protection used for appropriate conditions will reduce personal injuries.
- c. **Prevent unintentional starting. Ensure the switch is in the off-position before connecting to power source and/or battery pack, picking up or carrying the tool.** Carrying power tools with your finger on the switch or energising power tools that have the switch on invites accidents.

- d. **Remove any adjusting key or wrench before turning the power tool on.** A wrench or a key left attached to a rotating part of the power tool may result in personal injury.
  - e. **Do not overreach. Keep proper footing and balance at all times.** This enables better control of the power tool in unexpected situations.
  - f. **Dress properly. Do not wear loose clothing or jewellery. Keep your hair, clothing and gloves away from moving parts.** Loose clothes, jewellery or long hair can be caught in moving parts.
  - g. **If devices are provided for the connection of dust extraction and collection facilities, ensure these are connected and properly used.** Use of dust collection can reduce dust-related hazards.
  - h. **Do not let familiarity gained from frequent use of tools allow you to become complacent and ignore tool safety principles.** A careless action can cause severe injury within a fraction of a second.
- ## 4. Power tool use and care
- a. **Do not force the power tool. Use the correct power tool for your application.** The correct power tool will do the job better and safer at the rate for which it was designed.
  - b. **Do not use the power tool if the switch does not turn it on and off.** Any power tool that cannot be controlled with the switch is dangerous and must be repaired.
  - c. **Disconnect the plug from the power source and/or the battery pack from the power tool before making any adjustments, changing accessories, or storing power tools.** Such preventive safety measures reduce the risk of starting the power tool accidentally.
  - d. **Store idle power tools out of the reach of children and do not allow persons unfamiliar with the power tool or these instructions to operate the power tool.** Power tools are dangerous in the hands of untrained users.
  - e. **Maintain power tools.** Check for misalignment or binding of moving parts, breakage of parts and any other condition that may affect the power tool's operation. If damaged, have the power tool repaired before use. Many accidents are caused by poorly maintained power tools.
  - f. **Keep cutting tools sharp and clean.** Properly maintained cutting tools with sharp cutting edges are less likely to bind and are easier to control.
  - g. **Use the power tool, accessories and tool bits etc. in accordance with these instructions, taking into account the working conditions and the work to be performed.** Use of the power tool for operations different from those intended could result in a hazardous situation.
  - h. **Keep handles and grasping surfaces dry, clean and free from oil and grease.** Slippery handles and grasping surfaces do not allow for safe handling and control of the tool in unexpected situations.
- ## 5. Service
- a. **Have your power tool serviced by a qualified repair person using only identical replacement parts.** This will ensure that the safety of the power tool is maintained.

# MITRE SAW STAND SAFETY WARNINGS



**WARNING!** The appliance is not to be used by persons (including children) with reduced physical, sensory or mental capabilities, or lack of experience and knowledge, unless they have been given supervision or instruction.

Young children should be supervised to ensure that they do not play with the appliance.

- Always ensure the mitre saw base is properly secured to the stand prior to operation.
- Always ensure the stand legs have been locked into place prior to operation.
- Take care when moving the stand especially when a mitre saw is mounted.
- Do not use the stand for any other purpose than what it is intended for.
- Do not use the stand as a stepping stool or ladder.
- Make sure all moving parts are free from interference.
- Keep hands clear of all moving parts.
- Ensure the Mitre Saw Stand is set up on firm ground in a stable manner.

- Use the Mitre Saw Stand in a dry place protected from the rain.
- Be aware of overbalancing. When a large piece is cut from one end of a job, the remaining piece may be heavy enough to over-balance the Mitre Saw Stand. Always ensure the workpiece is well supported.
- When transporting the Mitre Saw Stand in a vehicle, always tie it down to prevent movement and possible damage.
- Check to make sure that all fixing screws and knobs are tight and all legs are locked into position before operation.
- The Mitre Saw Stand must be used only for its prescribed purpose. Any use other than those mentioned in these instructions will be considered a case of misuse.
- Ozito shall not be liable for any damage or injury resulting from such cases of misuse.
- Ozito shall not be liable for any changes made to the Mitre Saw Stand nor for any damage resulting from such changes.