

ozito

ROTARY HAMMER DRILL KIT

1500W

INSTRUCTION MANUAL

SPECIFICATIONS

Input:	230–240V ~ 50/60Hz
Power:	1500W
Impact Rate:	4,100bpm
Impact Energy:	5J
No Load Speed:	0-850/min
Accessory Fitment:	SDS+
Drilling Capacity:	Ø40mm (Timber) Ø32mm (Masonry) Ø13mm (Steel)
Weight:	4.4kg

ozito.com.au

3 YEAR

REPLACEMENT
WARRANTY*

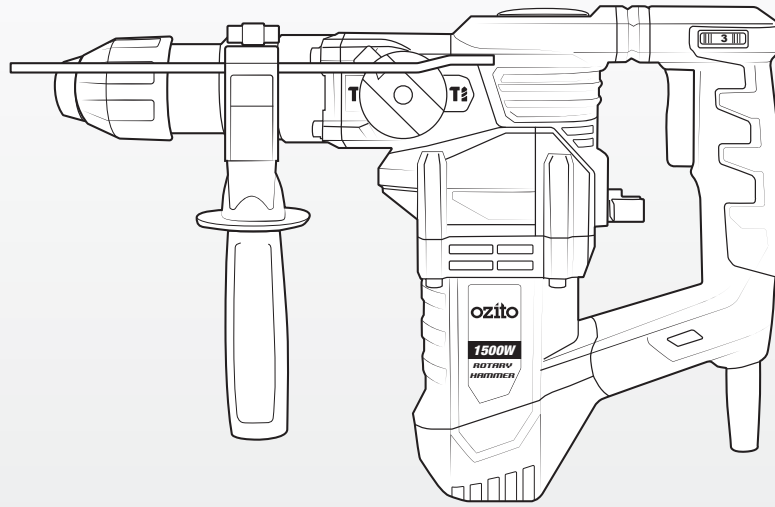

STANDARD EQUIPMENT

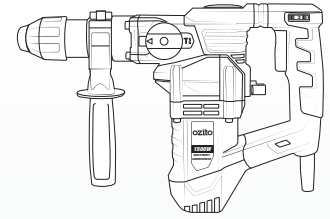

Rotary Hammer Drill & Side Handle

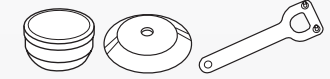

Grease Tub, Dust Cover & Pin Wrench

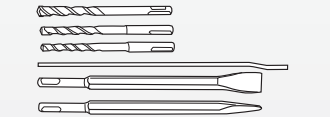

3 x Drill Bits, Depth Rod, Flat Chisel & Pointed Chisel

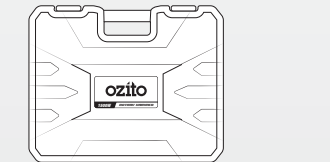

Kitbox

RHD-1550

WARRANTY

IN ORDER TO MAKE A CLAIM UNDER THIS WARRANTY YOU MUST RETURN THE PRODUCT TO YOUR NEAREST BUNNINGS WAREHOUSE WITH YOUR BUNNINGS REGISTER RECEIPT. PRIOR TO RETURNING YOUR PRODUCT FOR WARRANTY PLEASE TELEPHONE OUR CUSTOMER SERVICE HELPLINE:

Australia: 1800 069 486

New Zealand: 0508 069 486

TO ENSURE A SPEEDY RESPONSE PLEASE HAVE THE MODEL NUMBER AND DATE OF PURCHASE AVAILABLE. A CUSTOMER SERVICE REPRESENTATIVE WILL TAKE YOUR CALL AND ANSWER ANY QUESTIONS YOU MAY HAVE RELATING TO THE WARRANTY POLICY OR PROCEDURE.

The benefits provided under this warranty are in addition to other rights and remedies which are available to you at law.

Our goods come with guarantees that cannot be excluded at law. You are entitled to a replacement or refund for a major failure and for compensation for any other reasonably foreseeable loss or damage. You are also entitled to have the goods repaired or replaced if the goods fail to be of acceptable quality and the failure does not amount to a major failure.

Generally you will be responsible for all costs associated with a claim under this warranty, however, where you have suffered any additional direct loss as a result of a defective product you may be able to claim such expenses by contacting our customer service helpline above.

3 YEAR REPLACEMENT WARRANTY*

Your product is guaranteed for a period of **36 months from the original date of purchase**. If a product is defective it will be replaced in accordance with the terms of this warranty. Warranty excludes consumable parts, for example: valve adapters and accessories.

*This product is intended for DIY use only and replacement warranty covers domestic use.

WARNING

The following actions will result in the warranty being void.

- If the tool has been operated on a supply voltage other than that specified on the tool.
- If the tool shows signs of damage or defects caused by or resulting from abuse, accidents or alterations.
- Failure to perform maintenance as set out within the instruction manual.
- If the tool is disassembled or tampered with in any way.
- Professional, industrial or high frequency use.

KNOW YOUR PRODUCT

ROTARY HAMMER DRILL

1. Depth Rod
2. Accessory Locking Sleeve
3. Depth Rod Locking Screw
4. Side Mode Locking Button
5. Side Mode Dial
6. Grease Cap
7. Vibration Control Handle
8. On/Off Trigger
9. Speed Dial
10. Indicator LED
11. Rear Mode Selector
12. Side Handle
13. SDS+ Accessory Holder

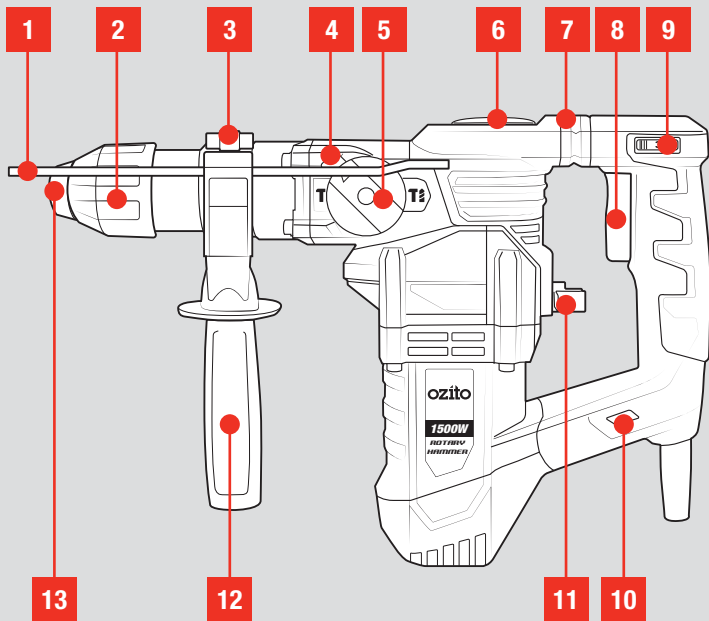

ONLINE MANUAL

Scan this QR Code with your mobile device to take you to the online manual.

3 YEAR REPLACEMENT WARRANTY*



SETUP & PREPARATION

1. ACCESSORIES



WARNING! ENSURE THE TOOL IS TURNED OFF AND DISCONNECTED FROM THE POWER SUPPLY BEFORE PERFORMING ANY OF THE FOLLOWING OPERATIONS.

Attaching The Side Handle

1. Loosen the side handle by rotating the lower section anti clockwise and then slide over the chuck and onto the neck of the drill.

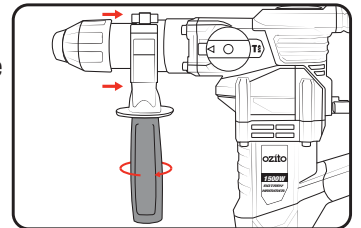

2. Rotate into the desired handle position and then push backwards so that the notch below the chuck inserts into one of the grooves in the upper handle.

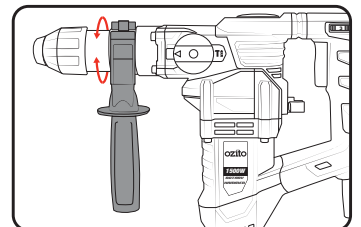

Note: Ensure the handle is pushed all the way back to avoid interference with the chuck.

3. Secure in position by rotating the lower section of the handle clockwise.

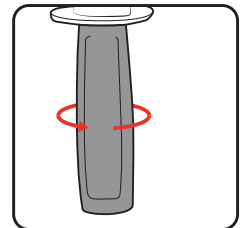

Attaching The Depth Rod

The depth rod allows you to drill to a pre-determined depth.

1. Loosen the depth rod securing nut then insert the depth rod.

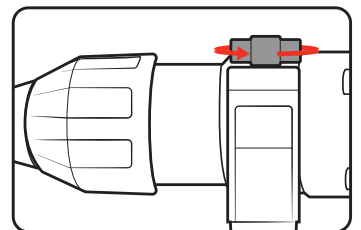

2. Adjust the depth rod so that the drill bit extends beyond the end of the depth rod to the required drilling depth.

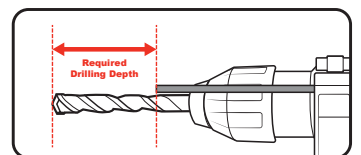

3. Tighten the depth rod securing nut to lock the depth rod into place.

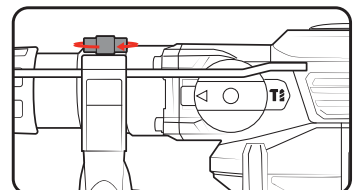

Installing SDS+ Accessories

1. Before using a drill bit in the hammer drill, ensure that the SDS+ accessory is clean of dust and debris.
2. Dip the SDS+ end of the accessory into the supplied tub of grease.

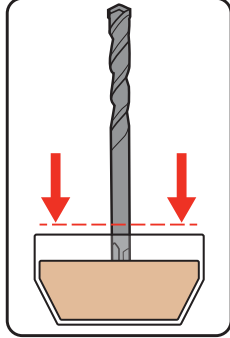

WARNING! WEAR GLOVES WHEN HANDLING GREASE.

3. Pull back the locking sleeve and insert the SDS+ accessory into the chuck.

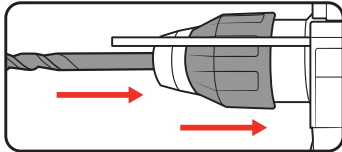

4. Rotate the accessory until it is inserted as far as possible into the locking sleeve.

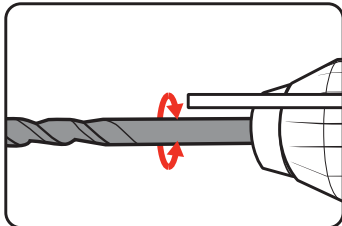

Note: You should hear a click when it is correctly inserted.

5. Pull on the SDS+ accessory to check it is locked in.

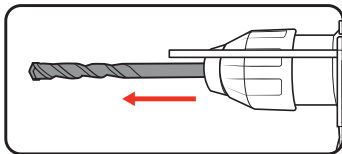

Note: It should leave approximately 10-20mm of movement. This is normal.

6. To remove the SDS+ accessory, pull back the locking sleeve and pull the accessory out.

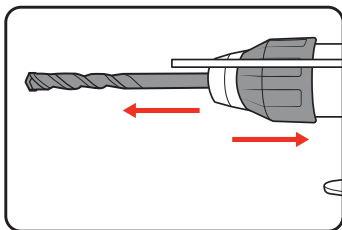

Using The Dust Cover

The cover catches dust and debris whilst using the drill upright or overhead.

1. Slide the cover over the end of the accessory.

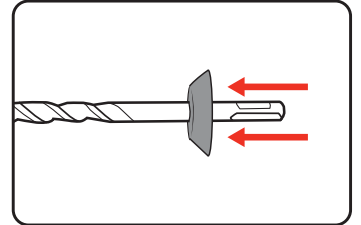

2. Add lubrication grease.

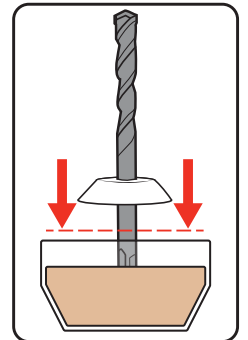

3. Insert the drill bit into the chuck as per usual.

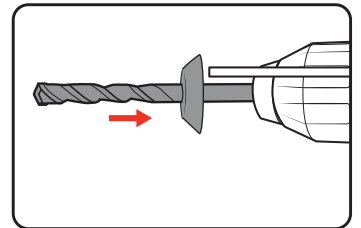

4. Press the dust cover to the end of the locking sleeve.

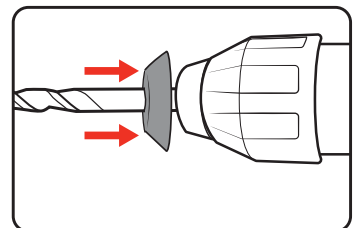

OPERATION

2. OPERATING MODES



WARNING! ENSURE THE DRILL IS NO LONGER ROTATING AND HAS COME TO A COMPLETE STOP BEFORE ATTEMPTING TO CHANGE MODES.

Changing Modes

The operating modes are controlled by changing the positions of the side and rear mode dials.

Note: To adjust the side mode dial, press the locking button while rotating the mode dial to the desired setting.

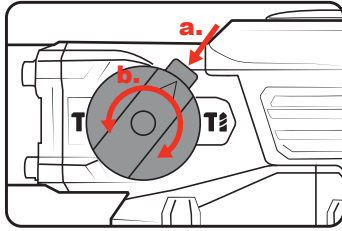

Drilling

Use this setting when you want the accessory to **rotate without hammer action. Ideal for drilling into timber or steel** when correct accessories for such materials are used.

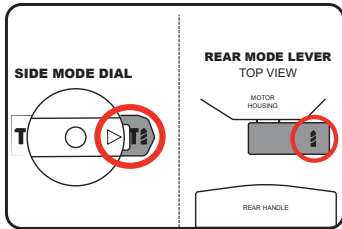

Rotate the side mode selector to the hammer/drill icon and the rear mode lever to the drill icon.

Hammer Drilling

Use this setting when **drilling holes in concrete and other masonry products. The hammer action will be in operation** while the drill bit rotates.

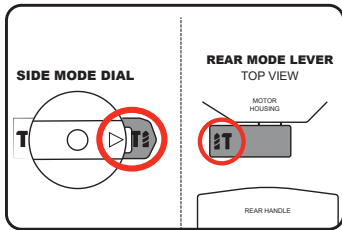

Rotate the side mode selector to the hammer/drill icon and the rear mode lever to the hammer drill icon.

Chiselling

Use this when you want the **hammer action without the drill action** which is ideal for "chiselling or chipping" away at masonry products. Pick or chisel accessory bits should be used.

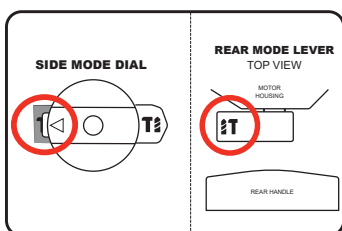

Rotate the mode selector to the chisel icon and the rear mode lever to the hammer drill icon.

3. USING THE HAMMER DRILL

On/Off Trigger

- 1 To start the tool, squeeze the on/off trigger.

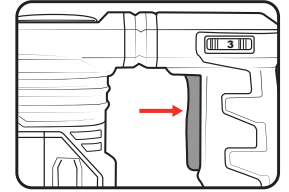

Note: The further you press the on/off trigger, the faster the tool will operate.

- 2 To stop the tool, release the on/off trigger.

Adjusting The Speed

- 1 Rotate the speed setting dial to the desired speed.

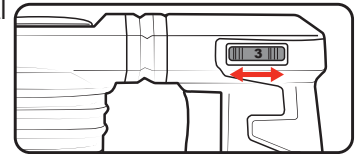

Using The Hammer Drill

Before starting to drill or chisel, perform a few simple checks.

- 1 Depress and release the trigger to ensure it is not locked on.
- 2 Ensure the workpiece is clamped and secured where possible.



- 3 Hold the drill firmly in the position you want to drill

- 4 Start the tool and move the tool into the workpiece.

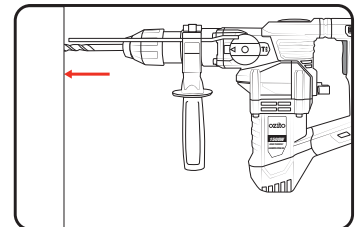

Note: Do not force the drill or apply side pressure. Let the tool do all the work.

5. To drill to a pre-determined depth, adjust the depth rod so that the drill bit protrudes past by the depth of the hole required.

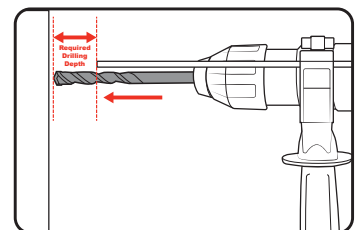

Then drill as normal until the depth rod touches the surface of the workpiece.

MAINTENANCE

WARNING! BEFORE CLEANING THE APPLIANCE OR CARRYING OUT ANY MAINTENANCE PROCEDURE, MAKE SURE THAT IT IS DISCONNECTED FROM THE POWER SUPPLY TO PREVENT ACCIDENTAL STARTING.

Cleaning

1. We recommend that you clean the appliance immediately after you use it.
2. Keep the safety devices free of dirt and dust as much as possible. Wipe the equipment with a clean cloth.
3. Clean the appliance regularly with a damp cloth and some soft soap. Do not use cleaning agents or solvents; these may be aggressive to the plastic parts in the appliance. Ensure that no water can get into the interior of the appliance.

Gear Box Grease Replenishment

WARNING! WEAR GLOVES WHEN HANDLING GREASE.

The grease in the gearbox will require replenishment after approximately 50 hours accumulative use. After this time, add approximately 50 grams (approximately 2 – 3 teaspoons) of the grease (supplied), into the gearbox.

First remove the grease cap from the drill by using the pin spanner. Once removed, add the grease through this hole. Ensure the grease cap is secured back into position prior to operation. If additional grease is required, please contact Ozito Customer Service.

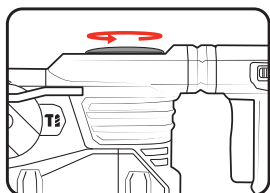

Storage

Pull the mains plug out of the socket, switch off the tool and make sure that it is secured in such a way that it cannot be started up again by any unauthorised person. Store the tool in a dry location which is not accessible to unauthorised persons.

Supply Cords

If replacement of the supply cord is necessary, this has to be done by a certified electrician in order to avoid a safety hazard.

Note: Ozito Industries will not be responsible for any damage or injuries caused by the repair of the tool by an unauthorised person or by mishandling of the tool.

DESCRIPTION OF SYMBOLS

V	Volts	Hz	Hertz
~	Alternating Current	W	Watts
J	Joules	bpm	beats per minute
mm	Millimetre		Double insulated
	Wear eye, ear & breathing protection		Regulatory Compliance Mark (RCM)
	Read Instruction Manual		Warning

CARING FOR THE ENVIRONMENT

Power tools that are no longer usable should not be disposed of with household waste but in an environmentally friendly way. Please recycle where facilities exist. Check with your local council authority for recycling advice.

Recycling packaging reduces the need for landfill and raw materials. Reuse of recycled material decreases pollution in the environment. Please recycle packaging where facilities exist. Check with your local council authority for recycling advice.

SPARE PARTS

Spare parts can be ordered from the Special Orders Desk at your local Bunnings Warehouse.

For further information, or any parts not listed here, visit www.ozito.com.au or contact Ozito Customer Service:

Australia 1800 069 486

New Zealand 0508 069 486

E-mail: enquiries@ozito.com.au

ELECTRICAL SAFETY



WARNING! When using mains-powered tools, basic safety precautions, including the following, should always be followed to reduce risk of fire, electric shock, personal injury and material damage. Read the whole manual carefully and make sure you know how to switch the tool off in an emergency, before operating the tool.

Save these instructions and other documents supplied with this tool for future reference.

This tool has been designed for 230V and 240V only. Always check that the power supply corresponds to the voltage on the rating plate.

Note: The supply of 230V and 240V on Ozito tools are interchangeable for Australia and New Zealand.



This tool is double insulated; therefore no earth wire is required.

Note: Double insulation does not take the place of normal safety precautions when operating this tool. The insulation system is for added protection against injury resulting from a possible electrical insulation failure within the tool.

Using an Extension Lead

Always use an approved extension lead suitable for the power input of this tool. Before use, inspect the extension lead for signs of damage, wear and ageing. Replace the extension lead if damaged or defective.

When using an extension lead on a reel, always unwind the lead completely. Use of an extension lead not suitable for the power input of the tool or which is damaged or defective may result in a risk of fire and electric shock.

The power supply for this product should be protected by a residual current device (rated at 30mA or less). A residual current device reduces the risk of electric shock.

GENERAL POWER TOOL SAFETY WARNINGS



WARNING! Read all safety warnings and all instructions. Failure to follow the warnings and instructions may result in electric shock, fire and/or serious injury.

Save all warnings and instructions for future reference. The term "power tool" in the warnings refers to your mains-operated (corded) power tool or battery-operated (cordless) power tool.

1. Work area safety

- a. **Keep work area clean and well lit.** Cluttered or dark areas invite accidents.
- b. **Do not operate power tools in explosive atmospheres, such as in the presence of flammable liquids, gases or dust.** Power tools create sparks which may ignite the dust or fumes.
- c. **Keep children and bystanders away while operating a power tool.** Distractions can cause you to lose control.

2. Electrical safety

- a. **Power tool plugs must match the outlet. Never modify the plug in any way. Do not use any adapter plugs with earthed (grounded) power tools.** Unmodified plugs and matching outlets will reduce risk of electric shock.
 - b. **Avoid body contact with earthed or grounded surfaces, such as pipes, radiators, ranges and refrigerators.** There is an increased risk of electric shock if your body is earthed or grounded.
 - c. **Do not expose power tools to rain or wet conditions.** Water entering a power tool will increase the risk of electric shock.
 - d. **Do not abuse the cord. Never use the cord for carrying, pulling or unplugging the power tool. Keep cord away from heat, oil, sharp edges or moving parts.** Damaged or entangled cords increase the risk of electric shock.
 - e. **When operating a power tool outdoors, use an extension cord suitable for outdoor use.** Use of a cord suitable for outdoor use reduces the risk of electric shock.
 - f. **If operating a power tool in a damp location is unavoidable, use a residual current device (RCD) protected supply.** Use of an RCD reduces the risk of electric shock.
- ## 3. Personal safety
- a. **Stay alert, watch what you are doing and use common sense when operating a power tool. Do not use a power tool while you are tired or under the influence of drugs, alcohol or medication.** A moment of inattention while operating power tools may result in serious personal injury.
 - b. **Use personal protective equipment. Always wear eye protection.** Protective equipment such as dust mask, non-skid safety shoes, hard hat, or hearing protection used for appropriate conditions will reduce personal injuries.
 - c. **Prevent unintentional starting. Ensure the switch is in the off-position before connecting to power source and/or battery pack, picking up or carrying the tool.** Carrying power tools with your finger on the switch or energising power tools that have the switch on invites accidents.

- d. **Remove any adjusting key or wrench before turning the power tool on.** A wrench or a key left attached to a rotating part of the power tool may result in personal injury.
 - e. **Do not overreach. Keep proper footing and balance at all times.** This enables better control of the power tool in unexpected situations.
 - f. **Dress properly. Do not wear loose clothing or jewellery. Keep your hair, clothing and gloves away from moving parts.** Loose clothes, jewellery or long hair can be caught in moving parts.
 - g. **If devices are provided for the connection of dust extraction and collection facilities, ensure these are connected and properly used.** Use of dust collection can reduce dust-related hazards.
 - h. **Do not let familiarity gained from frequent use of tools allow you to become complacent and ignore tool safety principles.** A careless action can cause severe injury within a fraction of a second.
- ## 4. Power tool use and care
- a. **Do not force the power tool. Use the correct power tool for your application.** The correct power tool will do the job better and safer at the rate for which it was designed.
 - b. **Do not use the power tool if the switch does not turn it on and off.** Any power tool that cannot be controlled with the switch is dangerous and must be repaired.
 - c. **Disconnect the plug from the power source and/or the battery pack from the power tool before making any adjustments, changing accessories, or storing power tools.** Such preventive safety measures reduce the risk of starting the power tool accidentally.
 - d. **Store idle power tools out of the reach of children and do not allow persons unfamiliar with the power tool or these instructions to operate the power tool.** Power tools are dangerous in the hands of untrained users.
 - e. **Maintain power tools.** Check for misalignment or binding of moving parts, breakage of parts and any other condition that may affect the power tool's operation. If damaged, have the power tool repaired before use. Many accidents are caused by poorly maintained power tools.
 - f. **Keep cutting tools sharp and clean.** Properly maintained cutting tools with sharp cutting edges are less likely to bind and are easier to control.
 - g. **Use the power tool, accessories and tool bits etc. in accordance with these instructions, taking into account the working conditions and the work to be performed.** Use of the power tool for operations different from those intended could result in a hazardous situation.
 - h. **Keep handles and grasping surfaces dry, clean and free from oil and grease.** Slippery handles and grasping surfaces do not allow for safe handling and control of the tool in unexpected situations.
- ## 5. Service
- a. **Have your power tool serviced by a qualified repair person using only identical replacement parts.** This will ensure that the safety of the power tool is maintained.

ROTARY HAMMER DRILL SAFETY WARNINGS



The appliance is not to be used by persons (including children) with reduced physical, sensory or mental capabilities, or lack of experience and knowledge, unless they have been given supervision or instruction.

Young children should be supervised to ensure that they do not play with the appliance.

WARNING! Before connecting a tool to a power source (mains switch power point receptacle, outlet, etc.) be sure that the voltage supply is the same as that specified on the nameplate of the tool. A power source with a voltage greater than that specified for the tool can result in serious injury to the user, as well as damage to the tool. If in doubt, do not plug in the tool. Using a power source with a voltage less than the nameplate rating is harmful to the motor.

- Wear ear protectors when impact drilling. Exposure to noise can cause hearing loss.
- Use auxiliary handle(s), if supplied with the tool. Loss of control can cause personal injury.
- Brace the tool properly before use. This tool produces a high output torque and without properly bracing the tool during operation, loss of control may occur resulting in personal injury.
- Hold power tool by insulated gripping surfaces, when performing an operation where the cutting accessory may contact hidden wiring or its own cord. Cutting accessory contacting a "live" wire may make exposed metal parts of the power tool "live" and could give the operator an electric shock.
- Before drilling into walls, ceilings etc, ensure that there are no concealed power cables or pipes in the cavity.
- Keep the cord clear of the drill accessory, do not wrap the cord around your arm or wrist.
- Prolonged use of a tool can cause injuries. Ensure you take regular breaks when using any tool for prolonged periods.
- Use thick cushioned gloves and limit the exposure time by taking frequent breaks.
- Vibration caused by the hammer action may be harmful to your hands and arms.
- Do not use the tool while on an unstable surface.
- Handling grease
 - Avoid contact with eyes. When exposure is likely wear suitable eye protection.
 - Wear gloves of impervious material if handling material for prolonged periods.

-Avoid breathing vapors or mists and use in well ventilated area.

Contact a doctor or Poisons Information Centre. Phone 131126 from anywhere in Australia or 0800 764 766 in New Zealand.

Safety instructions when using long drill bits

- Never operate at higher speed than the maximum speed rating of the drill bit. At higher speeds the bit is likely to bend if allowed to rotate freely without contacting the workpiece, resulting in personal injury.
- Always start drilling at low speed and with the bit tip in contact with the workpiece. At higher speeds the bit is likely to bend if allowed to rotate freely without contacting the workpiece, resulting in personal injury.
- Apply pressure only in direct line with the bit and do not apply excessive pressure. Bits can bend causing breakage or loss of control, resulting in personal injury.

WARNING! Some dust created by power sanding, sawing, grinding, drilling and other construction activities contain chemicals known to cause cancer, birth defects or other reproductive harm.

Some examples of these chemicals are:

- Lead from lead-based paints,
- Crystalline silica from bricks and cement and other masonry products,
- Arsenic and chromium from chemically treated timber.
- Asbestos-containing materials (Asbestos cement sheeting, fences, walls etc.

Your risk from exposure to these chemicals varies, depending on how often you do this type of work. To reduce your exposure to these chemicals: work in a well ventilated area and work with approved safety equipment, such as dust masks that are specially designed to filter out microscopic particles.