

QUALCAST

51cm

Self Propelled Lawnmower

Original Operating Instructions



POWERFUL 190CC BRIGGS & STRATTON 625 SERIES PETROL ENGINE
Ideal for medium to large gardens



ADJUSTABLE AND FOLDING HANDLE
Allows for handle to be adjusted for comfort and easy storage



51CM METAL DECK
For improved durability and long life



5 CENTRALLY ADJUSTED CUTTING HEIGHTS
Allows for precise cutting from 30mm - 75mm



60 LITRE GRASS COLLECTION BAG
Large volume helps to limit bag emptying



AFTER SALES SUPPORT

UK / IRELAND HELPLINE NO 0151 6491500
REP. IRELAND HELPLINE NO 1890 946244
WEB SUPPORT www.einhell-uk.co.uk

MODEL: QG-PM 51S B&S
MANUFACTURERS ARTICLE NO: 34.007.44



Contents

- 03. Safety Guide
- 04. Product Diagrams
- 10. Technical Data
- 12. Assembly
- 18. Declaration of Conformity
- 19. Product Guarantee

Packaging

The unit is supplied in packaging to prevent its being damaged in transit. This packaging is raw material and can therefore be reused or can be returned to the raw material system.

Important!

When using the equipment, safety precautions must be observed to avoid injuries and damage. Please read the complete operating instructions and safety regulations with due care. Keep this manual in a safe place, so that the information is available at all times. If you give the equipment to any other person, hand over these operating instructions and safety regulations as well. We cannot accept any liability for damage or accidents which arise due to a failure to follow these instructions and the safety instructions.

1. Safety instructions for hand-operated lawn mowers

Note

1. Read the directions with due care. Familiarize yourself with the settings and proper operation of the machine.
2. Never allow children or other persons who are not familiar with the operating instructions to use the mower.
3. Never mow in the direct vicinity of persons - especially children - or animals. Always keep in mind that the operator is responsible for accidents involving other persons and/or their property.

Preliminary measures

1. Always wear sturdy, non-slip footwear and long trousers when mowing. Never mow barefoot or in sandals.
2. Check the grounds on which the machine will be used and remove all objects that could be caught up and violently flung out of the chute.
3. Warning: Petrol is highly flammable! Therefore:
 - Only store petrol in containers designed to hold petroleum-based liquids.
 - Only refuel out in the open and do not smoke during the refueling process.
 - Always refuel the lawn mower before starting the engine. Always ensure that the fuel tank cap is closed when the engine is running and when the mower is hot; also do not refuel.
 - If petrol has overflowed, do not under any circumstances attempt to start the engine. Instead, remove the machine from the affected area. Avoid starting the engine until the petrol fumes have completely evaporated.
 - For safety reasons, the petrol tank and other tank closures must be replaced if they are damaged.
4. Replace defective exhausts.
5. Before using the mower, visually-inspect it to ensure that the blade, mounting bolts and the entire cutting apparatus are in good working order (i.e. not worn out or damaged). To prevent any imbalance, replace worn out or damaged blades and mounting bolts as a set only (if applicable).

1



2

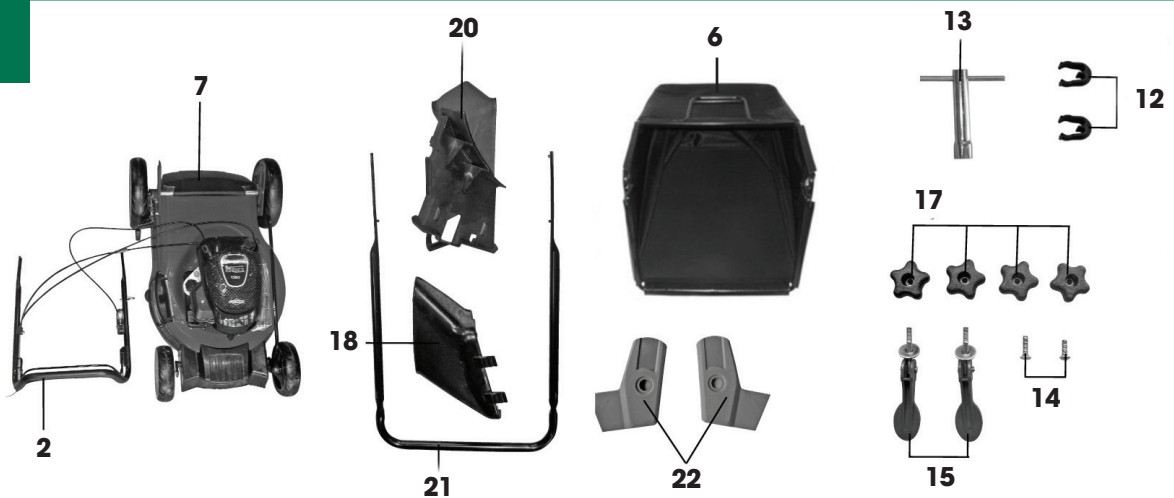

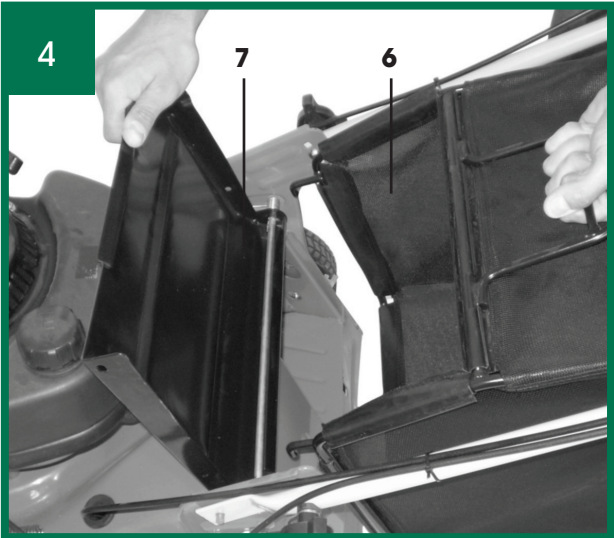
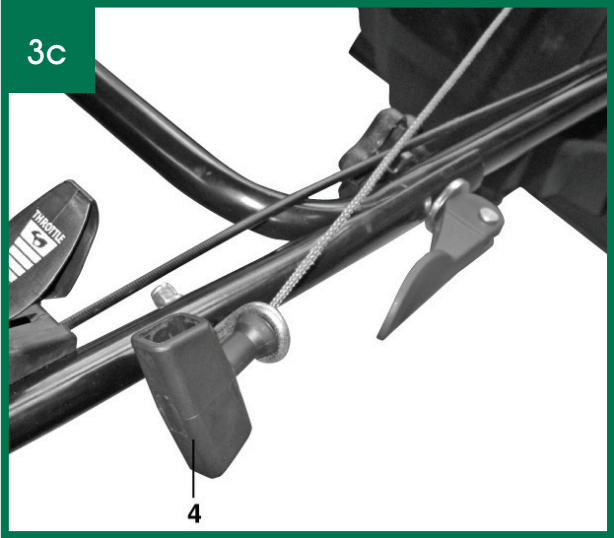
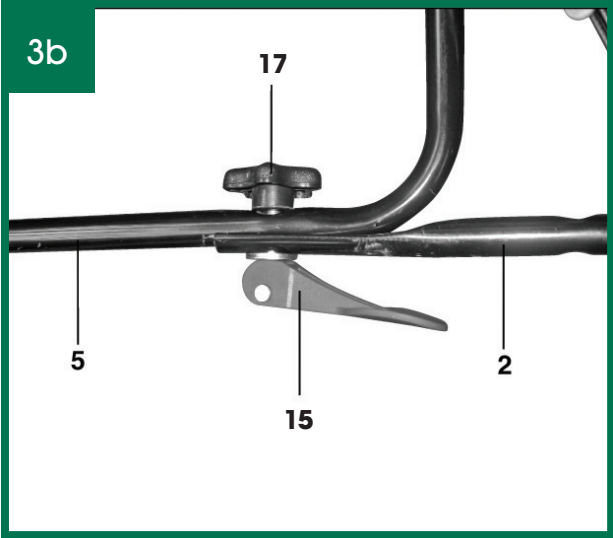
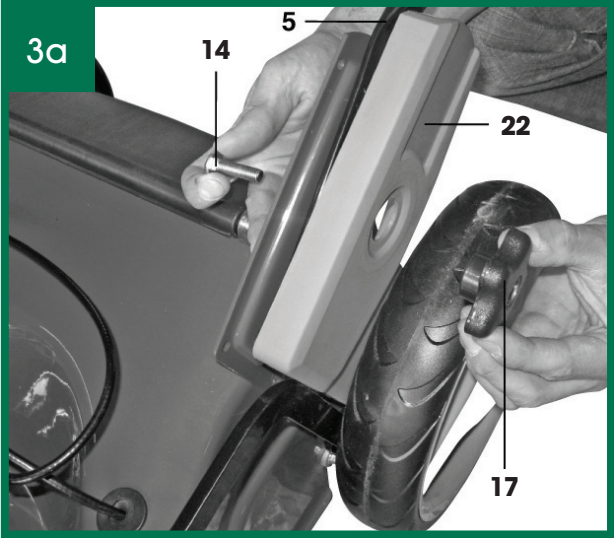
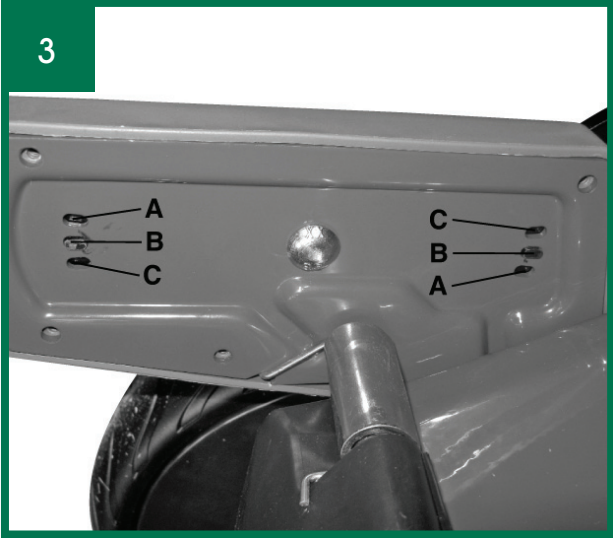

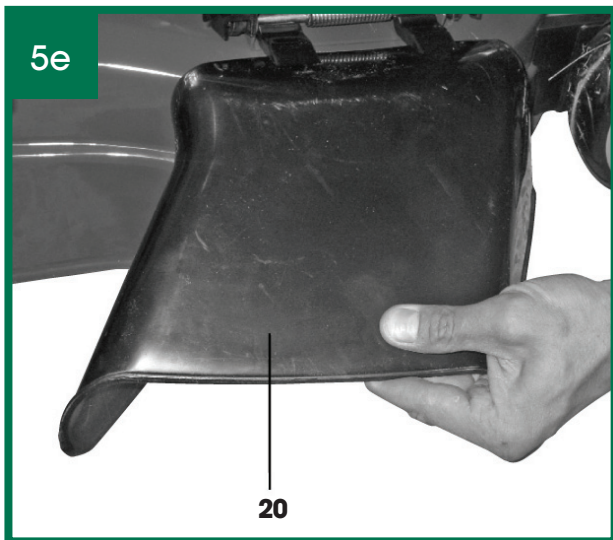
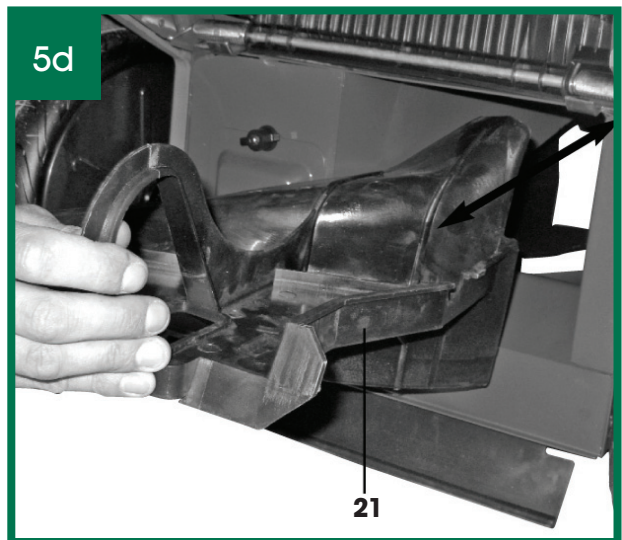

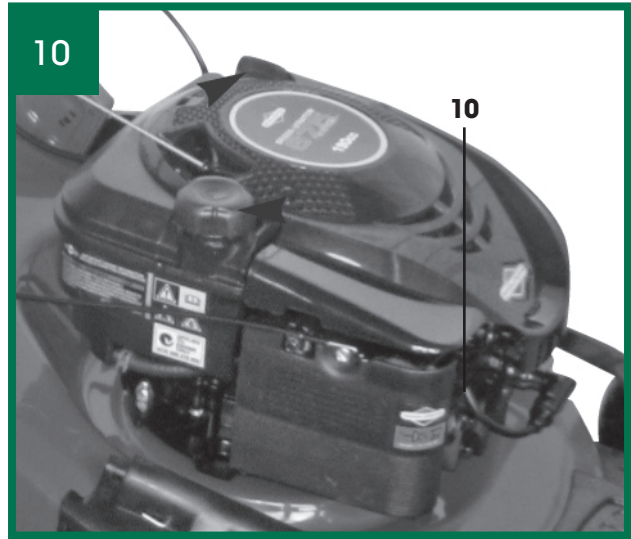
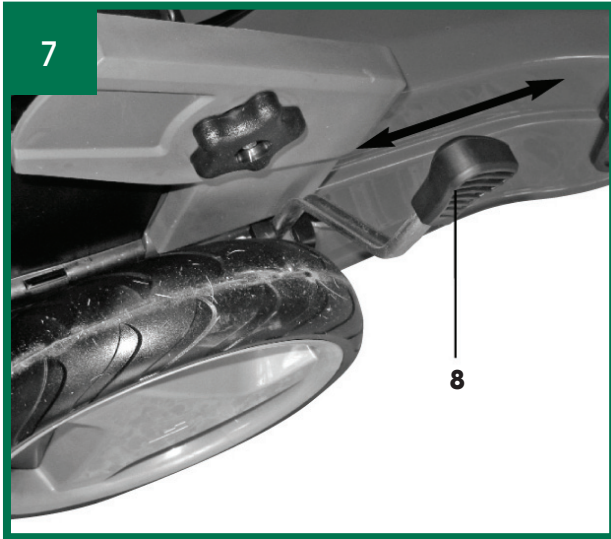

Handling

1. Do not let the combustion engine run in enclosed areas, as dangerous carbon monoxide gas can build up.
2. Only mow in broad daylight or in well-lit conditions. Avoid using the machine on wet grass as far as possible.
3. Always maintain good footing on inclines.
4. Only operate the machine at a walking pace.
5. For machines with wheels: Always mow across hills i.e. never straight up or straight down.
6. Be particularly careful when you change direction on a slope.
7. Do not mow on overly steep inclines.
8. Always be extra careful when turning the mower around and when pulling it towards you.
9. Switch off the lawn mower and ensure that the blade has stopped rotating whenever the mower has to be tilted for transporting over areas other than lawns and whenever it has to be moved from or to the area you want to mow.
10. Never use the lawn mower if the blade or safety grilles are damaged, or without the attached guards, e.g. deflectors and/or grass catching devices.
11. Do not adjust or overclock the engine speed settings.
12. Release the engine brake before you start the engine.
13. Start the engine with care, in accordance with the manufacturer's instructions. Make sure that your feet are far enough away from the mower blade!
14. Do not tilt the lawn mower when you start the engine unless the mower must be raised off of the ground a little in order to start it. In the latter case, tilt the mower as little as absolutely necessary and only raise the side opposite to that of the user.
15. Never start the engine while standing in front of the chute.
16. Never put your hands or feet near or under any rotating parts. Keep clear of the chute opening at all times.
17. Never lift or carry a lawn mower with the engine running.
18. Switch off the engine and pull the spark plug boot:
 - before you dislodge any blockages or clogs in the chute.
 - before carrying out any checks, cleaning, maintenance or other work on the lawn mower
 - if the lawn mower strikes a foreign body, examine it for signs of damage and carry out any necessary repairs before restarting and continuing to work with the mower. If the lawn mower begins to experience exceptionally strong vibrations, immediately switch it off and check it.
19. Switch off the engine:
 - when you leave the lawn mower.
 - before you refuel.
20. When you switch off the engine, move the speed lever to the Off position. Close the petrol stopcock.
21. Operation of the machine at higher than normal speed can lead to an increased risk of accidents.
22. Take care when carrying out installation work on the machine, and avoid trapping fingers between the blade and the fixed parts of the machine.

Maintenance and storage

1. Make sure that all nuts, bolts and screws are tightened securely and that the machine is in safe working condition.
2. **Never store the mower (with petrol in the tank) inside a building in which petrol fumes could come into contact with open flames or sparks.**
3. Allow the motor to cool before you put the lawn mower in an enclosed area.
4. In order to avoid fire hazards, keep the engine, exhaust and the area around the fuel tank free from grass, leaves and leaking grease (oil).
5. Routinely check the collection bag for signs of wear and impaired functionality.
6. For your own safety, replace worn or damaged parts without delay.
7. If the fuel tank should require emptying this should only be done in the open air where it is advisable to use a petrol suction pump (available from Einhell UK - call 0151 649 1500).

CAUTION!

Read all safety regulations and instructions. Any errors made in following the safety regulations and instructions may result in an electric shock, fire and/or serious injury.

Keep all safety regulations and instructions in a safe place for future use.

Explanation of the symbols on the machine (Fig. 11):

- 1) Read the operating instructions
- 2) **Important!** Danger from catapulted parts. Keep a safe distance.
- 3) **Important!** Switch off the engine and pull the spark plug boot before doing any maintenance, repair, cleaning or adjustment work.
- 4) Fill with oil and fuel before starting the mower.
- 5) **Caution!** Wear ear protection and safety goggles.
- 6) Engine start/stop lever (I=Engine on; 0=Engine off)
- 7) Drive lever (clutch lever)

2. Layout (Fig. 1 + 2)

1. Engine start/stop lever – engine brake
2. Top push bar
3. Throttle lever
4. Starter cable
5. Lower push bar
6. Grass collection bag
7. Ejector flap
8. Cutting height adjustment
9. Tank filler cap
10. Oil-filler neck
11. Oil drainage screw
12. 2 x cable ties
13. Spark plug wrench
14. 2 x square head screws for top push bar
15. 2 lever cam screws for upper push bar with high speed clamping function
16. Side ejector cover
17. 4 x star knobs for push bar
18. Drive lever (clutch lever)
19. Drive wheel (left and right)
20. Side ejector adaptor
21. Mulching adaptor
22. Cover for lower push bar

3. Proper operation

The petrol lawn mower is intended for private use i.e. for use in home and gardening environments.

Private use of the lawn mower refers an annual operating time generally not exceeding that of 50 hours, during which time the machine is primarily used to maintain small-scale, residential lawns and home/hobby gardens. Public facilities, sporting halls, and agricultural/forestry applications are excluded.

Please note that our equipment has not been designed for use in commercial, trade or industrial applications. Our warranty will be voided if the machine is used in commercial, trade or industrial businesses or for equivalent purposes.

The operating instructions as supplied by the manufacturer must be kept and referred to in order to ensure that the lawn mower is properly used and maintained. The instructions contain valuable information on operating, maintenance and servicing conditions.

Important! Due to the high risk of bodily injury to the user, the lawn mower may not be used to trim bushes, hedges or shrubs, to cut scaling vegetation, planted roofs, or balcony-grown grass, to clean (suck up) dirt and debris off walkways, or to chop up tree or hedge clippings. Moreover, the lawn mower may not be used as a power cultivator to level out high areas such as molehills.

For safety reasons, the lawn mower may not be used as a drive unit for other work tools or toolkits of any kind.

4. Technical data

Note: The enclosed manual from Briggs & Stratton provides detailed technical data on the engine!

Engine type:	Single cylinder four-stroke engine, 190 ccm
Working speed:	2800 min ⁻¹
Fuel:	standard petrol
Cutting height adjustment:	central, (30-75 mm)
Cutting width:	510 mm
L _{pA} sound pressure level:	87.8 dB(A)
L _{WA} sound power level:	98 dB(A)
Uncertainty measurement:	2dB
Vibration a _{hw}	6.36 m/s ²
Uncertainty measurement:	1,5m/s
Weight: (without oil)	40.7 kg

5. Before starting the equipment

5.1 Assembling the components

Some parts of the lawnmower need to be assembled. For quick and easy assembly, read and follow the instructions below.

Important! You will need the following additional tools (not supplied) for assembly, and also for maintenance work:

- A flat oil drip tray (for changing the oil)
- A 1 litre measuring jug (oil/petrol resistant)
- A petrol can
- A funnel (suitable for the tank's petrol filler neck)
- Household wipes (to wipe up oil/petrol residue; dispose of these at a filling station)
- A petrol suction pump (plastic, available from Einhell UK Ltd - call 0151 649 1500 (IRE 189 094 6244))
- An oil can with hand pump (available from DIY stores)

Assembly

1. Take the mower and attachment parts out of the packaging and check that all parts are present (Fig. 2).
2. Affix the lower push bar (Fig. 3a/Item 5) to the mower housing and set the desired working height. 3 different working heights are available. Each peg on the lower push bar can be inserted into a hole situated directly opposite to it, on the mower housing, for example A-A (Fig. 3). The lower push bar must be equally adjusted on both sides. Now affix the cover (Fig. 3a/Item 22) and attach the push bar (5) using the square head screws (14) and the star knobs (17) as shown in Figure 3a.
3. Fasten the top push bar to the bottom push bar using a lever cam screw (Fig. 3b/Item 15) and a star knob (Fig. 3b/Item 17) on each side. Make sure that the lobes of the lever cam screws are folded towards the inside so that the high speed clamping function remains operational.
4. Insert the grip of the starter cord (Fig. 3c/Item 4) into the hook provided for that purpose as shown in Figure 3c.
5. Fasten the cords to the push bar with the supplied cable ties (Fig. 3d/Item. 12).
6. Lift the ejector flap (Fig. 4 / Item 7) with one hand and hook in the grass bag as shown in Figure 4.

5.2 Setting the cutting height

Important! Adjust the cutting height only when the engine is switched off and the plug boot has been pulled.

- Before you begin to mow, check to ensure that the blade is not blunt and that none of the fasteners are damaged. To prevent any imbalance, replace blunt and/or damaged blades as a set only (if applicable). To carry out this check, first switch off the engine and pull the spark plug boot.
- The cutting height is centrally adjusted with the cutting height adjustor lever (Fig. 7/Item 8). Up to 5 different cutting heights can be selected.

- Pull the adjustor lever out and select the desired cutting height. The lever snaps into the desired position.

6. Operation

Note: For detailed information on the engine & oil, refer to the enclosed manual from Briggs & Stratton.

Important. The engine does not come with oil in it. Therefore, be sure to add oil before starting the engine. The oil level in the engine must be checked each time before mowing (see the Briggs & Stratton manual). You will also need to fill the fuel tank with petrol, as this is also not supplied upon delivery.

In order to avoid any unintentional start-ups of the lawn mower, it comes equipped with an engine brake (Fig. 5a/Item 1) which must be pulled back before the engine can be started. When the engine control lever is released it must return to its initial position, at which point the engine automatically switches off.

You can control the rotation speed of the blade using the speed lever (Fig. 6).



Before you start mowing, you should run through this operation several times in order to ensure that the machine is working properly.

Whenever you need to perform any kind of adjustment and/or repair work on your lawn mower, wait until the blade has come to a complete stop.

Always switch off the engine before carrying out any adjustments, maintenance or repairs.

Note:

1. Engine brake (Fig. 5a/Item 1): Use the lever to stop the engine. When you release the lever the engine and the blade stop automatically. To mow, hold the lever in the working position (Fig. 5b). Before you start to mow, check the start/stop lever several times to be sure that it is working properly. Ensure that the tension cable can be smoothly operated (i.e. is not catching or kinked in any way).

2. Speed lever (Fig. 6): Move this lever in order to increase or decrease the engine speed.
(Tortoise  = Slow / Hare  = Fast).

3. Drive lever (clutch lever) (Fig. 5a/Item 18): If you press this (Fig. 5c) the clutch for the drive will be closed and the lawnmower will start to move with the motor running. Release the drive lever in good time to stop the moving lawnmower. Practice starting and stopping before you use the mower for the first time until you are familiar with controlling the mower.

4. **Caution:** The blade begins to rotate as soon as the engine is started.

Important: Before you start the engine, move the motor brake several times to be sure that the stop cable is properly working. Note: The engine is factory set to a speed that is optimal for cutting and blowing grass into the collection bag and is designed to provide many years of use.

5. Check the oil level.

6. Fill the tank with petrol when it is empty, using a funnel and measuring vessel. Make sure that the petrol is clean.

Note: Use only unleaded petrol as fuel.

Warning: Never use more than one safety petrol can. Do not smoke when refueling. Switch off the engine before refueling and allow the engine to cool down for a few minutes.

To Start the Engine

7. Ensure that the ignition cable is connected to the spark plug.

8. Press the red primer button 5 times (Fig. 10).

9. Move the speed lever to the Hare  setting (Fig. 6).

10. Stand behind the mower. Place one hand on the engine start/stop lever and pull the bars together (Fig. 5a Fig. 5b). Place the other hand on the starter handle.

11. Start the engine using the reversing starter (Fig.3c/Item 4). To do this pull the handle approx. 10 – 15 cm (until you feel a resistance) and then start the engine with a sharp pull. If the engine does not start, pull the handle again. This could take up to 10 pulls.

Important! Never allow the starter cord to snap back.

Note: In cold weather, it may be necessary to repeat the starting process several times.

12. When the engine is at working temperature it can be started in the Tortoise  setting (Fig. 6).

To start the mower moving forward

Once the engine is running, operate the engine drive; by pulling the Drive lever towards the top push bar (Fig. 5c). Always walk behind the lawnmower whilst the drive is working.

To stop the mower moving forward

Release the Drive lever away from the top push bar (Fig. 5b). The engine will still be running & the blade will still be rotating.

To stop the engine

(Always try to release the Drive lever, before stopping the engine). Release the engine start/stop lever (Fig. 5a). The Engine will stop running & the blade will stop rotating.

Mulching

In the mulching mode the cuttings are shredded in the enclosed mower housing and then spread back onto the lawn. It is not necessary to gather and dispose of the grass.

Important: Mulching is only possible if the lawn is relatively short. Optimum results can be achieved only with a mulching blade (available as an accessory).

To use the mulching function, remove the grass collection bag, slide the mulching adaptor into the ejector opening (Fig. 5d/Item 20) and close the ejector opening.

Side ejector

You should fit the mulching adaptor (Fig. 5d / Item 21) in order to use the side ejector. Connect the side ejector adaptor (Fig. 5e/Item 18) as shown in Figure 5e.

6.1 Before mowing

Important information

1. Make sure that you are properly dressed when mowing. Wear sturdy, non-slip footwear; do not wear sandals or tennis shoes.

2. Inspect the blade. A blade that is bent or damaged in any other way must be immediately exchanged for a genuine Einhell replacement blade.

3. Do not fill the fuel tank indoors, but rather out in

the open. Use a filling funnel and a measuring jug. Wipe off any spilled petrol.

4. Read and follow the instructions in the operating manual as well as the information regarding the engine and accessory equipment. Store the manual in a place where it can be readily accessed by other users of the machine.

5. Exhaust gas is dangerous. Only start the engine out in the open.

6. Make sure that all the guards are fitted and that they are in good working order.

7. The machine should only be operated by persons who are well informed with the way it works, and who are in reasonably good physical condition.

8. It can be dangerous to mow the grass when it is wet. Try to ensure that you only mow the grass when it is dry.

9. Advise children and others to keep well away from the lawn mower.

10. Never mow the grass in poor visibility.

11. Remove all loose objects from the lawn before you start mowing the grass.

6.2 Tips for proper mowing

Important! Never open the chute flap when the grass collection bag has been detached (to be emptied) and the engine is still running. The rotating blade can cause serious injuries!

Always carefully fasten the chute flap and collection bag. Switch off the engine before emptying the collection bag.

Always ensure that a safe distance (provided by the length of the long handles) is maintained between the user and the mower housing. Be especially careful when mowing and changing direction on slopes and inclines. Maintain a solid footing and wear sturdy, non-slip footwear and long trousers. Always mow along the incline (not up and down).

For safety reasons, the lawn mower may not be used to mow inclines whose gradient exceeds 15 degrees. Use special caution when backing up and pulling the lawn mower. Tripping hazard!

6.3 Mowing

Only use a sharp blade that is in good condition.

This will prevent the grass blades from fraying and the lawn from turning yellow.

Try to mow in straight lines for a nice, clean look in so doing, the mowing swaths should always overlap each other by a few centimeters in order to avoid bare strips.

Keep the underside of the mower housing clean and remove grass build-up. Deposits not only make it more difficult to start the mower; they decrease the quality of the cut and make it harder for the machine to bag the grass. Always mow along inclines (not up and down). Slightly turning the front wheels up the hill while mowing will assist the mower in producing a straight line. Select the cutting height according to the length of the grass. If the lawn has grown quite a bit, mow over it several times so that no more than 4 cm of grass are cut at one time.

Switch off the engine before inspecting the blade. Keep in mind that the blade continues to rotate for a few seconds after the engine has been switched off. Never attempt to manually stop the blade.

Regularly check to see if the blade is securely attached, is in good condition and is sharp. If the contrary is the case, sharpen the blade or replace it. In the event that the blade strikes an object, immediately switch off the lawn mower and wait for the blade to come to a complete stop. Then inspect the condition of the blade and the blade mount. Replace any parts that are damaged.

Tips for proper mowing:

1. Pay attention to ensure that you do not run into or over anything that could damage the mower.

The lawn mower could be damaged and/or the machine could inflict bodily injury.

2. A hot engine, exhaust or drive unit can burn the skin if touched. Thus, do not touch these parts unless the mower has been switched off for some time and you know that they have cooled down!

3. Use extra caution when mowing on inclines and steep grades.

4. Do not use the mower if the daylight or artificial light levels are insufficient.

5. Check the mower, the blade and other parts if

they have struck a foreign object or if the machine vibrates more than usual.

6. Do not make any adjustments or repairs until the engine has been switched off. Pull the plug boot off the spark plug.
7. Pay special attention if you are mowing directly next to a street or are close by one (traffic). Always keep the grass chute pointed away from the street.
8. Avoid mowing in places where the wheels have trouble gripping or mowing is unsafe in any other way. Before you back up, ensure that nobody is standing behind you (especially little children and pets who are more difficult to see).
9. When mowing over thick, high grass, select the highest cutting level and mow at a slower speed. Before you remove any grass or blockages of any kind, switch off the engine and pull the plug boot.
10. Never remove any safety-related parts.
11. Never fill the engine with petrol when it is hot or is running.

6.4 Emptying the collection bag

As soon as grass clippings start to trail the lawn mower, it is time to empty the collection bag.

Important! Before taking off the grass collection bag, switch off the engine and wait until the blade has come to a stop.

To take off the grass collection bag, use one hand to lift up the chute flap and the other to grab onto the grass collection bag handle (Fig. 4). Remove the grass collection bag. For safety reasons, the chute flap automatically falls down after removing the grass collection bag and closes off the rear chute opening. If any grass remains in the opening, it will be easier to restart the engine if you pull the mower back approx. 1 metre.

Do not use your hands or feet to remove clippings in or on the mower housing, but instead use suitable tools such as a brush or a hand broom. Ensure that both the engine and the blade are stopped before attempting to remove clippings and debris.

In order to ensure that the majority of grass clippings are picked up, the inside of both the catch bag and especially the air grill must be

cleaned after each use.

Re-attach the catch bag only when the engine is switched off and the blade is stopped.

Using one hand, lift up the chute flap, while grabbing onto the grass collection bag handle with the other. Hook on the grass collection bag from the top. (see Fig. 4).

6.5 After mowing

1. Allow the engine to cool before you put the lawn mower in an enclosed area.
2. Remove grass, foliage, grease and oil before storing the mower. Do not place any objects on top of the mower.
3. Check all the screws and nuts once more before you start to use the lawn mower again. Tighten any loose screws.
4. Also be sure to empty the grass collection bag.
5. Pull the spark plug boot to prevent unauthorized use.
6. Ensure that you do not park the mower next to any source of danger. Petrol fumes can lead to explosions.
7. Only original parts or parts approved by the manufacturer may be used for repairs (see c).
8. If the lawn mower is not going to be used for an extended period, empty the petrol tank using a petrol suction pump.
9. Tell your children not to use the mower. It is not a toy.
10. Never place petrol near an ignition source. Always use a can that is approved to store petrol. Keep petrol away from children.
11. Oil and maintain the machine.

7. Cleaning, maintenance, storage, transport and ordering of spare parts

Important: The enclosed engine manual from Briggs & Stratton provides maintenance information and maintenance interval information on the engine.

Important: Never work on or touch conducting parts on the

ignition unit with the engine running. Always pull the spark plug boot from the spark plug before starting any cleaning or maintenance. Never perform any work on the machine while it is running. Any work not described in these Operating Instructions must be performed by an authorized service workshop only.

7.1 Cleaning

After each use, the mower should be thoroughly cleaned (especially the underside and blade receptacle).

Note: Before you tilt the lawnmower onto its side, empty the fuel tank completely with a petrol pump. The lawnmower must not be tilted more than 90 degrees. The simplest time to remove dirt and grass is directly after mowing. Dried residual grass and dirt could cause damage to the mowing operation. Make sure the grass ejector canal is free from residual pieces of grass and remove these if necessary. Never clean the mower with a direct jet of water or a high pressure cleaner. The motor must stay dry. Aggressive cleaning agents such as cold cleaning solvent or petroleum ether must not be used.

7.2 Maintenance

7.2.1 Wheel axles and wheel hubs

These should be lightly greased once a season. To do so, remove the wheel caps with a screwdriver and slacken the fastening screws on the wheels.

7.2.2 Blade

For safety reasons you should only ever have your blade sharpened, balanced and mounted by a service workshop. For optimum results it is recommended that the blade should be inspected once a year.

Changing the blade (Fig. 8)

Only ever use original spare parts when having the blade replaced. The marking on the blade must be matched with the number given in the list of spare parts. Never have any other model of blade fitted.

Damaged blades

Should the blade, in spite of all precautions, come into contact with an obstruction, shut down the engine immediately and pull the spark plug boot. Tip the lawn mower onto its side and check

the blade for damage. Damaged or bent blades must be replaced. Never attempt to bend a bent blade back to straight again. Never mow the lawn with a bent or heavily worn blade as this will cause vibrations and can lead to further damage to the lawn mower.

Important: There is a risk of injury if you work with a damaged blade.

Resharpener the blade

The blades can be resharpened with a metal file. In order to avoid imbalance, the blade should be resharpened by a service workshop.

7.2.3 Care and adjustment of the cables

Oil the cables at regular intervals and check that they move easily.

7.2.4 Repairs

After any repair or maintenance work, check that all safety-related parts are in place and in proper working order.

All parts which may cause injury must be kept where they are inaccessible to children or others.

Important: In accordance with product liability legislation we are not liable for any damages caused by improper repairs or the use of spare parts that are not original spare parts or parts approved by us. In addition, we are also not liable for any damages arising from improper repairs. Such work should be performed by a customer services workshop or authorized specialist. The same applies to accessory parts.

7.2.5 Times of use

Please comply with statutory regulations, which may vary from location to location.

7.3 Preparing the mower for long-term storage

Caution: Do not empty the petrol tank in enclosed areas, near fire or when smoking. Petrol fumes can cause explosions and fire.

1. Empty the petrol tank with a petrol suction pump.
2. Start the engine and let it run until any remaining petrol has been used up.
3. Clean the cooling fins of the cylinder and the housing.

4. Be sure to clean the entire machine to protect the paint.

5. Store the machine in a well-ventilated place.

IMPORTANT!

7.4 Preparing the mower for transportation

1. Empty the petrol tank (see item 7.3.1).
2. Always let the engine run until it has used up the remainder of petrol in the tank.
3. Empty the engine oil from the warm engine.
4. Remove the spark plug boot from the spark plug.
5. Clean the equipment.
6. Remove the start tension cable from the hook (Fig. 3c). Slacken the wing nuts and fold down the upper push bar.
7. Wedge a few layers of corrugated cardboard between the upper and lower push bars and the engine in order to prevent any chafing.

7.5 Ordering replacement parts

Please quote the following data when ordering replacement parts:

- Type of machine QG-PM 51S B&S
- Article number of the machine 34.007.44
- Identification number of the machine 11010
- Replacement part number of the part required

8. Disposal and recycling

The unit is supplied in packaging to prevent its being damaged in transit. This packaging is raw material and can therefore be reused or can be returned to the raw material system.

The unit and its accessories are made of various types of material, such as metal and plastic. Defective components must be disposed of as special waste. Ask your local council for information.

9. Faults and remedies for faults

Caution: Always switch off the engine and pull the ignition cable before starting any inspection or adjustment work.





Caution: If, after making an adjustment or repair to the engine, you let it run for a few minutes, remember that the exhaust and other parts will get hot. Thus, do not touch parts that emanate heat, as these may burn you.

Important. If problems arise in connection with the engine, please refer to the enclosed manual from Briggs & Stratton.

FAULT	POSSIBLE CAUSES	REMEDY
Loud while running, machine vibrates heavily	<ul style="list-style-type: none">- Screws are loose- Blade fasteners are loose- Blade is unbalanced	<ul style="list-style-type: none">- Check screws- Check blade fasteners- Replace blade
Engine does not start	<ul style="list-style-type: none">- Brake lever not pressed- Fuel tank is empty	<ul style="list-style-type: none">- Press brake lever- Refill with fuel
Mower does not drive forward	<ul style="list-style-type: none">- Drive Lever not pressed	<ul style="list-style-type: none">- Press Drive lever
Uneven mowing results	<ul style="list-style-type: none">- Blade is blunt- Cutting height is too low- Engine speed is too low	<ul style="list-style-type: none">- Sharpen the blade- Set correct height- Set lever to max.
Unsatisfactory bagging of the grass	<ul style="list-style-type: none">- Engine speed is too low- Cutting height is too low- Blade is worn- Basket is clogged	<ul style="list-style-type: none">- Set speed lever to max.- Set correct height- Replace the blade- Empty the collection bag

Notes

Declaration of conformity

ISC GmbH · Eschenstraße 6 · D-94405 Landau/Isar		
<h3>DECLARATION OF CONFORMITY</h3>		
<p>D erklart folgende Konformitat gema EU-Richtlinie und Normen fur Artikel</p> <p>GB explains the following conformity according to EU directives and norms for the following product</p> <p>F dclare la conformit suivante selon la directive CE et les normes concernant l'article</p> <p>I dichiara la seguente conformit secondo la direttiva UE e le norme per l'articolo</p> <p>NL verklaart de volgende overeenstemming conform EU richtlijn en normen voor het product</p> <p>E declara la siguiente conformidad a tenor de la directiva y normas de la UE para el artculo</p> <p>P declara a seguinte conformidade, de acordo com a directiva CE e normas para o artigo</p> <p>DK attesterer flgende overensstemmelse i medfr af EU-direktiv samt standarder for artikel</p> <p>S frklarar fljande verensstammelse enl. EU-direktiv och standarder fr artikeln</p> <p>FIN vakuuttaa, ett tuote tytta EU-direktiivin ja standardien vaatimukset</p> <p>EE tendab toote vastavust EL direktiivile ja standarditele</p> <p>CZ vydava nsledujc prohlaen o shod podle smrnice EU a norem pro vrobek</p> <p>SL potrjuje sledeo skladnost s smernico EU in standardi za izdelak</p> <p>SK vydava nasledujce prehlasenie o zhode podl'a smernice E a noriem pre vrobok</p> <p>H a cikkekhez az EU-irnyvonal s Normak szerint a kvetkez konformitast jelenti ki</p>	<p>PL deklaruje zgodnoc wymienionego poniej artykuu z nastpujcymi normami na podstawie dyrektywy WE.</p> <p>BG декларира съответното съответствие съгласно Директива на ЕС и норми за артикул</p> <p>LV paskaidro šdu atbilstību ES direktīvai un standartiem</p> <p>LT apibūdina šj atitikim EU reikalavimams ir preks normoms</p> <p>RO declar urmtoarea conformitate conform directivei UE și normelor pentru articolul</p> <p>GR dglnei tin aklouthe simmrfwse smfwna me tin Odgia EK kai ta prtupta ga to proon</p> <p>HR potvruje sljedeu usklaenost prema smjernicama EU i normama za artikl</p> <p>BB potvruje sljedeu usklaenost prema smjernicama EU i normama za artikl</p> <p>RS potvruje sledeu usklaenost prema smernicama EZ i normama za artikal</p> <p>RU следующим удостоверяется, что следующие продукты соответствуют директивам и нормам ЕС</p> <p>UKR проголошує про зазначену нижче вдповднсть виробу директивам та стандартам ЄС на вирб</p> <p>MK ja izjavuva slednata soobrznost согласно E-direktivata i normite za artikli</p> <p>TR rn ile ilgili AB direktifleri ve normlari gereince aaida aıklanan uygunluu belirtir</p> <p>N erklerer flgende samsvar i henhold til EU-direktivet og standarder for artikkel</p> <p>IS Lysir uppfyllingu EU-reglna og annarra stala vru</p>	
<p align="center">Petrol Lawn Mower QG-PM 51 S B&S (Qualcast)</p>		
<input type="checkbox"/> 2009/105/EC <input type="checkbox"/> 2006/95/EC <input type="checkbox"/> 2006/28/EC <input type="checkbox"/> 2005/32/EC <input checked="" type="checkbox"/> 2004/108/EC <input type="checkbox"/> 2004/22/EC <input type="checkbox"/> 1999/5/EC <input type="checkbox"/> 97/23/EC <input type="checkbox"/> 90/396/EC <input type="checkbox"/> 89/686/EC_96/58/EC	<input checked="" type="checkbox"/> 2006/42/EC <input type="checkbox"/> Annex IV <small>Notified Body: Notified Body No.: Reg. No.:</small> <input checked="" type="checkbox"/> 2000/14/EC_2005/88/EC <input type="checkbox"/> Annex V <input checked="" type="checkbox"/> Annex VI <small>Noise: measured L_{WA} = 96 dB (A); guaranteed L_{WA} = 98 dB (A) P = 3,59 kW; L/Ø = 51 cm Notified Body: TÜV Süd Industrie Service GmbH, Westendstrasse 199, 80686 Mnchen (0036)</small> <input checked="" type="checkbox"/> 2004/26/EC <small>Emission No.: e11*97/68SA*2004/26*0296*01</small>	
<p align="center">Standard references: EN 836; EN ISO 14982</p>		
<p>Landau/Isar, den 01.07.2010</p>	 _____ Weichselgartner/General Manager	 _____ Frank/Product-Management
<p>First CE: 10 Art.-No.: 34.007.44 I.-No.: 11010 Subject to change without notice</p>	<p align="right">Archive-File/Record: 3400740-39-4160705-08 Documents registrar: Mayn Robert Wiesenweg 22, D-94405 Landau/Isar</p>	

GUARANTEE CERTIFICATE



Year

Dear Customer,

In the unlikely event that your device develops a fault, please contact our Customer service department on the telephone number shown below.

1. These guarantee terms cover additional guarantee rights and do not affect your statutory warranty rights. Claims must be accompanied by Proof of Purchase. This must be in the form of a Sales receipt or Bank statement and must show that the product has been purchased within 2 years prior to the claim from the retailer that it was originally sold to.

2. Our guarantee covers problems caused by material or manufacturing defects, and will result in the repair of these defects or replacement of the device with a like for like or similar article. Please note that our devices have not been designed for use in commercial, trade or industrial applications. Consequently, the guarantee is invalidated if the equipment is used in commercial, trade or industrial applications or for other equivalent activities.

3. The following are also excluded from our guarantee:

- A) Faults due to accidents, customer misuse, or unauthorized repairs
- B) Consumable Parts such as Blades/Chains/Trimmer lines/Spooles/Vacuum bags/Spark plugs or Filters
- C) Failure due to lack of routine maintenance
- D) Failure as a result of not using the equipment in accordance with the manual and safety instructions
- E) The adjustment or lubrication cables, drive belts, or recoil starters

4. The guarantee is valid for a period of 2 years starting from the purchase date of the device. Guarantee claims should be submitted before the end of the guarantee period within two weeks of the defect being noticed. No guarantee claims will be accepted after the end of the guarantee period. The original guarantee period remains applicable to the device even if repairs are carried out or parts are replaced. In such cases, the work performed or parts fitted will not result in an extension of the guarantee period, and no new guarantee will become active for the work performed or parts fitted. This also applies when an on-site Service is used.

5. Please keep your sales receipt in a safe place. If the defect is covered by our guarantee your device will either be repaired under the terms of guarantee or we will send you a replacement device. This device may be re-conditioned or Like for like replacement.

EINHELL UK LTD HELPLINE: + 44 151 649 1500
REP. IRELAND HELPLINE: 1890 946244

HOME RETAIL GROUP
489-499 AVEBURY BOULEVARD, SAXON GATE WEST, CENTRAL MILTON KEYNES, MK9 2NW



QUALCAST

AFTER SALES SUPPORT

UK / IRELAND HELPLINE NO 0151 6491500

REP. IRELAND HELPLINE NO 1890 946244

WEB SUPPORT www.einhell-uk.co.uk

MODEL NUMBER: QG-PM 51S B&S

MANUFACTURERS ARTICLE NO: 34.007.44