

## RECIPROCATING SAW

12V Lithium Ion

### INSTRUCTION MANUAL

### SPECIFICATIONS

Input Voltage:	12V
No Load Speed:	0-2,800spm
Stroke Length:	13.78mm
Cutting Capacities:	50mm (Timber) 5mm (Steel)
Tool Weight:	1.05kg

ozito.com.au

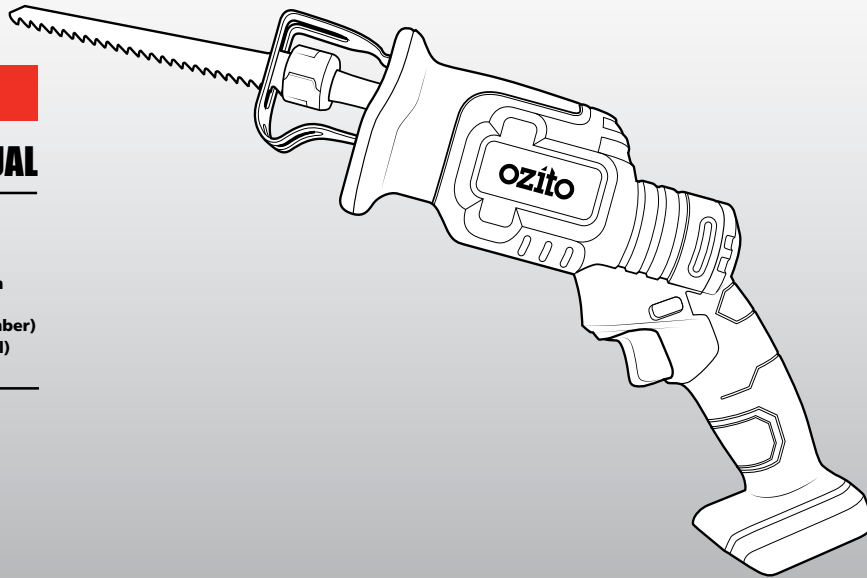

### WHAT'S IN THE BOX

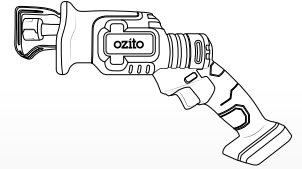

Cordless Reciprocating Saw

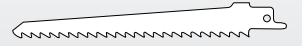

Wood Cutting Blade



Metal Cutting Blade

# 3 YEAR REPLACEMENT WARRANTY

ZLRSS-012

## WARRANTY

IN ORDER TO MAKE A CLAIM UNDER THIS WARRANTY YOU MUST RETURN THE PRODUCT TO YOUR NEAREST BUNNINGS WAREHOUSE WITH YOUR BUNNINGS REGISTER RECEIPT. PRIOR TO RETURNING YOUR PRODUCT FOR WARRANTY PLEASE TELEPHONE OUR CUSTOMER SERVICE HELPLINE:

Australia 1800 069 486  
New Zealand 0508 069 486

TO ENSURE A SPEEDY RESPONSE PLEASE HAVE THE MODEL NUMBER AND DATE OF PURCHASE AVAILABLE. A CUSTOMER SERVICE REPRESENTATIVE WILL TAKE YOUR CALL AND ANSWER ANY QUESTIONS YOU MAY HAVE RELATING TO THE WARRANTY POLICY OR PROCEDURE.

The benefits provided under this warranty are in addition to other rights and remedies which are available to you at law. Our goods come with guarantees that cannot be excluded at law. You are entitled to a replacement or refund for a major failure and for compensation for any other reasonably foreseeable loss or damage. You are also entitled to have the goods repaired or replaced if the goods fail to be of acceptable quality and the failure does not amount to a major failure.

Generally you will be responsible for all costs associated with a claim under this warranty, however, where you have suffered any additional direct loss as a result of a defective product you may be able to claim such expenses by contacting our customer service helpline above.

### 3 YEAR REPLACEMENT WARRANTY

Your product is guaranteed for a period of **36 months from the original date of purchase** and is intended for DIY (Do It Yourself) use only. If a product is defective it will be replaced in accordance with the terms of this warranty. **Lithium Ion batteries and chargers are covered by a 12 month warranty.** Warranty excludes consumable parts, for example: accessories, carbon brushes etc.

### WARNING

**The following actions will result in the warranty being void.**

- If the tool has been operated on a supply voltage other than that specified on the tool.
- If the tool shows signs of damage or defects caused by or resulting from abuse, accidents or alterations.
- Failure to perform maintenance as set out within the instruction manual.
- If the tool is disassembled or tampered with in any way.
- Professional, industrial or high frequency use.

# KNOW YOUR PRODUCT

## CORDLESS RECIPROCATING SAW

- |                   |                          |
|-------------------|--------------------------|
| 1 Shoe            | 4 Variable Speed Trigger |
| 2 Blade Holder    | 5 Sure Grip Handle       |
| 3 Lock-Off Button | 6 Battery Seating        |

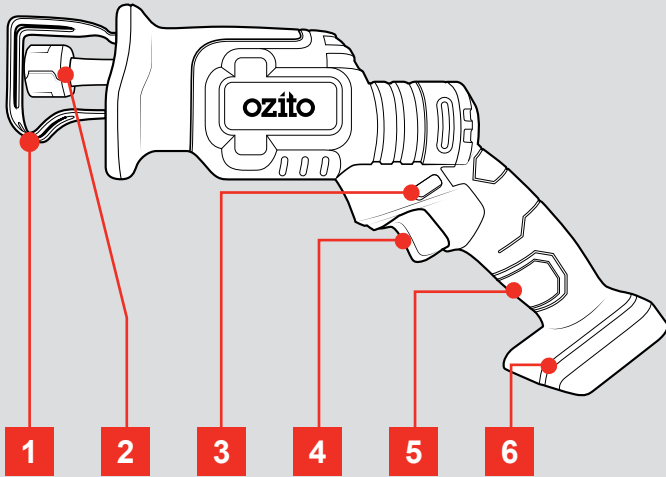

## ACCESSORIES

- 7 Timber Cutting Blade
- 8 Metal Cutting Blade

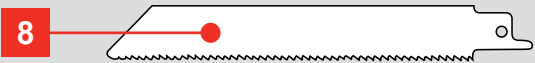

## BATTERY & CHARGER

This tool is compatible with all batteries and chargers from the Ozito Home-12volt range.

### ONLINE MANUAL

Scan this QR Code with your mobile device to take you to the online manual.



# SETUP & PREPARATION

## 1. INSERTING & REMOVING BLADES



**WARNING!** ENSURE THE TOOL IS SWITCHED OFF AND THE BATTERY IS REMOVED BEFORE PERFORMING ANY OF THE FOLLOWING TASKS.

1. Rotate the blade holder anti-clockwise.

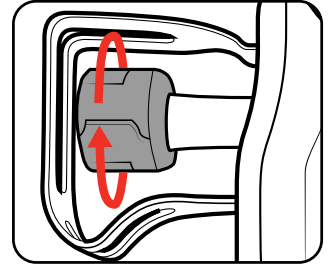

2. Insert the blade through the pivot shoe and into the blade holder.

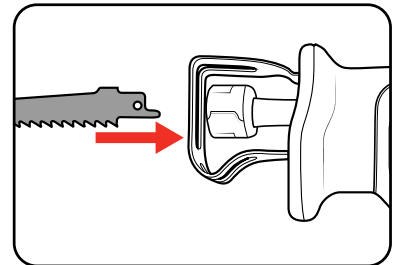

3. Release the blade holder.

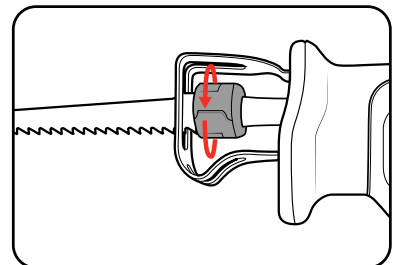

4. Pull on the blade to ensure it is properly secured.

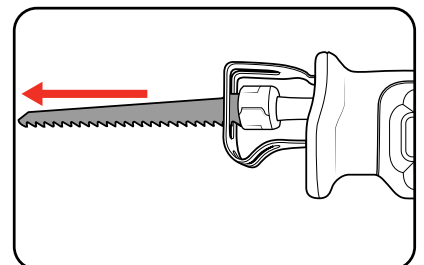

**3** YEAR REPLACEMENT WARRANTY

# OPERATION

## 2. FITTING THE BATTERY

### Inserting and Removing the Battery

1. Align the ribs of the battery with the recess at the base of the of the saws rear handle and push in until it clicks into place.

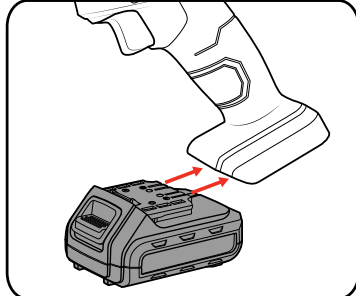

2. To remove, press and hold the battery release tab and then slide out

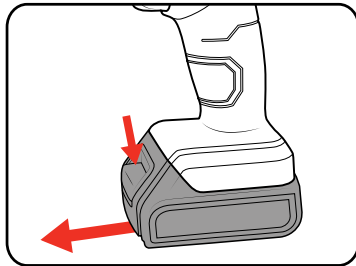

## 3. CONTROLS

### On/Off Trigger

1. Press and hold the lock-off button

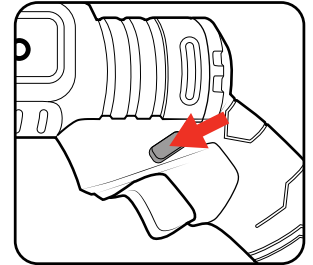

2. Squeeze the on/off Trigger

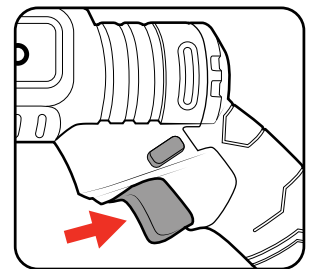

3. To stop the saw, release the on/off trigger

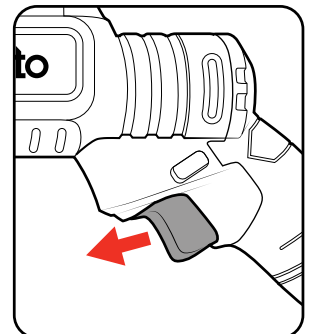

## 4. CUTTING PROCEDURE

1. Firmly press the Shoe against the work piece.

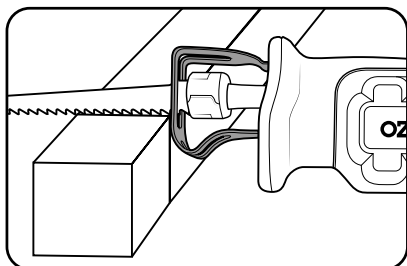

2. Turn the reciprocating saw on.

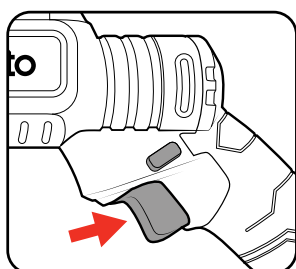

3. Hold the tool with the handles, ensuring that your hand cannot slip onto the blade. Keep the shoe firmly against the workpiece throughout the cut.

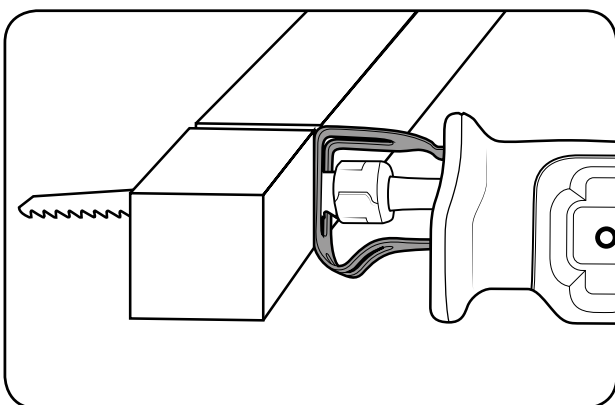

**NOTE:** KEEP BOTH HANDS AWAY FROM THE BLADE AND MOVING PARTS AT ALL TIMES. ENSURE THERE ARE NO LOOSE CLOTHING OR HAIR NEAR THE TOOL.

**NOTE:** DO NOT ALLOW THE TOOL TO BOUNCE. IF THE SHOE IS HELD AWAY FROM THE WORK PIECE DURING OPERATION, STRONG VIBRATION AND/OR TWISTING MAY OCCUR CAUSING THE BLADE TO SNAP DANGEROUSLY.

# MAINTENANCE

 **WARNING!** Always ensure the tool has completely stopped and the battery is removed prior to any maintenance

- After each use, blow air through the tool housing to ensure it is free from all dust, dirt, etc. Build up of dust, dirt particles may cause the tool to overheat and shorten the life of the tool.
- If the housing of the reciprocating saw requires cleaning, do not use solvents but a moist soft cloth or soft brush only.
- Never let any liquid get inside the tool, never immerse any part of the tool into liquid.
- When not in use, the reciprocating saw should be stored in a dry, frost free location not within the reach of children

Note: Ozito Industries will not be responsible for any damage or injuries caused by the repair of the reciprocating saw by an unauthorised person or by mishandling of the reciprocating saw..

# ELECTRICAL SAFETY

 **WARNING!** When using mains-powered tools, basic safety precautions, including the following, should always be followed to reduce risk of fire, electric shock, personal injury and material damage.

Read the whole manual carefully and make sure you know how to switch the tool off in an emergency, before operating the tool.  
Save these instructions and other documents supplied with this tool for future reference.

The charger has been designed for 230V and 240V only. Always check that the power supply corresponds to the voltage on the rating plate.

Note: The supply of 230V and 240V on Ozito tools are interchangeable for Australia and New Zealand.



This tools charger is double insulated therefore no earth wire is required.

If the supply cord is damaged, it must be replaced by an electrician or a power tool repairer in order to avoid a hazard.













**Note:** Double insulation does not take the place of normal safety precautions when operating this tool. The insulation system is for added protection against injury resulting from a possible electrical insulation failure within the tool.

## Using an Extension Lead

Always use an approved extension lead suitable for the power input of this tool. Before use, inspect the extension lead for signs of damage, wear and ageing. Replace the extension lead if damaged or defective.

When using an extension lead on a reel, always unwind the lead completely. Use of an extension lead not suitable for the power input of the tool or which is damaged or defective may result in a risk of fire and electric shock.

# DESCRIPTION OF SYMBOLS

	Volts		Hertz
	Alternating current		Amp hour
	Direct current		No load speed
	Regulator compliance mark (RCM)		Read instruction manual
	Warning		Revolutions or reciprocation per minute
	Wear eye protection		Diameter

# TROUBLESHOOTING

## Sparking visible through the housing air vents

A small amount of sparking may be visible through the housing vents. This is normal and does not indicate a problem.

## The tool loses power during use

- Battery could be low and requires charging.
- The tool could have overloaded due to excessive pressure. Turn the product back on and reduce load.

# CARING FOR THE ENVIRONMENT



Power tools that are no longer usable should not be disposed of with household waste but in an environmentally friendly way. Please recycle where facilities exist. Check with your local council authority for recycling advice.



Recycling packaging reduces the need for landfill and raw materials. Reuse of recycled material decreases pollution in the environment. Please recycle packaging where facilities exist. Check with your local council authority for recycling advice.

# SPARE PARTS

Spare parts can be ordered from the Special Orders Desk at your local Bunnings Warehouse.

For further information, or any parts not listed here, visit [www.ozito.com.au](http://www.ozito.com.au) or contact Ozito Customer Service:

Australia 1800 069 486

New Zealand 0508 069 486

E-mail: [enquiries@ozito.com.au](mailto:enquiries@ozito.com.au)



# GENERAL POWER TOOL SAFETY WARNINGS - PERSONAL SAFETY



**WARNING!** Read all safety warnings and all instructions. Failure to follow the warnings and instructions may result in electric shock, fire and/or serious injury.

Save all warnings and instructions for future reference. The term "power tool" in the warnings refers to your mains-operated (corded) power tool or battery-operated (cordless) power tool.

## 1. Work area safety

- a. **Keep work area clean and well lit.** Cluttered or dark areas invite accidents.
- b. **Do not operate power tools in explosive atmospheres, such as in the presence of flammable liquids, gases or dust.** Power tools create sparks which may ignite the dust or fumes.
- c. **Keep children and bystanders away while operating a power tool.** Distractions can cause you to lose control.

## 2. Electrical safety

- a. **Power tool plugs must match the outlet. Never modify the plug in any way. Do not use any adapter plugs with earthed (grounded) power tools.** Unmodified plugs and matching outlets will reduce risk of electric shock.
- b. **Avoid body contact with earthed or grounded surfaces, such as pipes, radiators, ranges and refrigerators.** There is an increased risk of electric shock if your body is earthed or grounded.
- c. **Do not expose power tools to rain or wet conditions.** Water entering a power tool will increase the risk of electric shock.
- d. **Do not abuse the cord. Never use the cord for carrying, pulling or unplugging the power tool. Keep cord away from heat, oil, sharp edges or moving parts.** Damaged or entangled cords increase the risk of electric shock.
- e. **When operating a power tool outdoors, use an extension cord suitable for outdoor use.** Use of a cord suitable for outdoor use reduces the risk of electric shock.
- f. **If operating a power tool in a damp location is unavoidable, use a residual current device (RCD) protected supply.** Use of an RCD reduces the risk of electric shock.

## 3. Personal safety

- a. **Stay alert, watch what you are doing and use common sense when operating a power tool. Do not use a power tool while you are tired or under the influence of drugs, alcohol or medication.** A moment of inattention while operating power tools may result in serious personal injury.
- b. **Use personal protective equipment. Always wear eye protection.** Protective equipment such as dust mask, non-skid safety shoes, hard hat, or hearing protection used for appropriate conditions will reduce personal injuries.
- c. **Prevent unintentional starting. Ensure the switch is in the off-position before connecting to power source and/or battery pack, picking up or carrying the tool.** Carrying power tools with your finger on the switch or energising power tools that have the switch on invites accidents.

- d. **Remove any adjusting key or wrench before turning the power tool on.** A wrench or a key left attached to a rotating part of the power tool may result in personal injury.
- e. **Do not overreach. Keep proper footing and balance at all times.** This enables better control of the power tool in unexpected situations.
- f. **Dress properly. Do not wear loose clothing or jewellery. Keep your hair, clothing and gloves away from moving parts.** Loose clothes, jewellery or long hair can be caught in moving parts.
- g. **If devices are provided for the connection of dust extraction and collection facilities, ensure these are connected and properly used.** Use of dust collection can reduce dust-related hazards.
- h. **Do not let familiarity gained from frequent use of tools allow you to become complacent and ignore tool safety principles.** A careless action can cause severe injury within a fraction of a second.

## 4. Power tool use and care

- a. **Do not force the power tool. Use the correct power tool for your application.** The correct power tool will do the job better and safer at the rate for which it was designed.
- b. **Do not use the power tool if the switch does not turn it on and off.** Any power tool that cannot be controlled with the switch is dangerous and must be repaired.
- c. **Disconnect the plug from the power source and/or the battery pack from the power tool before making any adjustments, changing accessories, or storing power tools.** Such preventive safety measures reduce the risk of starting the power tool accidentally.
- d. **Store idle power tools out of the reach of children and do not allow persons unfamiliar with the power tool or these instructions to operate the power tool.** Power tools are dangerous in the hands of untrained users.
- e. **Maintain power tools. Check for misalignment or binding of moving parts, breakage of parts and any other condition that may affect the power tool's operation. If damaged, have the power tool repaired before use.** Many accidents are caused by poorly maintained power tools.
- f. **Keep cutting tools sharp and clean.** Properly maintained cutting tools with sharp cutting edges are less likely to bind and are easier to control.
- g. **Use the power tool, accessories and tool bits etc. in accordance with these instructions, taking into account the working conditions and the work to be performed.** Use of the power tool for operations different from those intended could result in a hazardous situation.
- h. **Keep handles and grasping surfaces dry, clean and free from oil and grease.** Slippery handles and grasping surfaces do not allow for safe handling and control of the tool in unexpected situations.

## 5. Service

- a. **Have your power tool serviced by a qualified repair person using only identical replacement parts.** This will ensure that the safety of the power tool is maintained.



# RECIPROCATING SAW SAFETY WARNINGS



**WARNING!**

- **Hold power tool by insulated gripping surfaces, when performing an operation where the cutting accessory may contact hidden wiring or its own cord.** Cutting accessory contacting a "live" wire may make exposed metal parts of the power tool "live" and could give the operator an electric shock.
- **This appliance is not intended for use by persons** (including children) with reduced physical, sensory or mental capabilities, or lack of experience and knowledge, unless they have been given supervision or instruction concerning use of the appliance by a person responsible for their safety.
- **Recommendations for the use of a residual current device** with a rated residual current of 30mA or less.
- **Wear a safety helmet, safety glasses and/or face shield.** It is also highly recommended that you wear a dust mask, ear protection and padded gloves.
- **Check the blade carefully for cracks or damage prior to operation.** Replace cracked or damaged blades immediately.
- **Hold the tool firmly during operation. Always hold the adjustable pivoting shoe firmly against the work piece.**
- Ensure no one is below you when using the tool in elevated conditions.
- Do not point the tool at anyone in the immediate vicinity.



**WARNING!** When making a "blind" cut (you can't see behind what is being cut), be sure that hidden electrical wiring or water pipes are not in the path of the cut. If wires are present, they must be disconnected at their power source by a qualified person or avoided to prevent the possibility of lethal shock or fire.

- Water pipes in "blind" areas must be drained and capped before cutting.
- If the blade hits against objects during operation, damage to the tool or dangerous blade breakage may occur.

- **Watch out for cut-off portions** of the work piece being cut. They may fall and cause injury to you or someone near you.
- When cutting metals, be cautious of hot flying debris.
- **Do not touch the blade or the work piece immediately after operation;** they may be extremely hot and could potentially burn your skin.
- **If you withdraw the blade from the work piece during operation, a strong reaction could be produced,** which could cause the blade to snap or cause you to lose your grip and/or control of the saw. Always switch off the tool and wait until the blade has come to a complete stop before withdrawing the blade from the work piece.



**WARNING!** Some dust created by power sanding, sawing, grinding, drilling and other construction activities contains chemicals known to cause cancer, birth defects or other reproductive harm.

Some examples of these chemicals are:

- Lead from lead-based paints;
- Crystalline silica from bricks, cement and other masonry products, and;
- Arsenic and chromium from chemically-treated timber.

The risk from such exposures vary depending on how often you do this type of work. To reduce your exposure to these chemicals; work in a well ventilated area, and work with approved safety equipment, such as those dust masks that are specifically designed to filter out microscopic particles.

Always wear eye protection and a dust mask for dusty applications and when drilling/chiselling overhead. Sanding particles can be absorbed by your eyes and inhaled easily and may cause health complications.