

MAINTENANCE

5. CLEANING & STORING

IMPORTANT! BEFORE CLEANING YOUR WET & DRY VAC OR CARRYING OUT ANY MAINTENANCE PROCEDURE, MAKE SURE THAT THE MOTOR IS OFF AND THE VAC DISCONNECTED FROM THE POWER SUPPLY TO PREVENT ACCIDENTAL STARTING.

Cleaning

Keep all safety devices, air vents and the motor housing free of dirt and dust as far as possible.

We recommend that you clean the equipment immediately after you use it.

Cleaning the motor housing

Clean the appliance regularly with a damp cloth and some soft soap. Do not use cleaning agents or solvents; these may be aggressive to the plastic parts in the appliance.

Cleaning the tank

The tank can be cleaned with a damp cloth and some soft soap or under running water, depending on the amount of dirt.

Cleaning the foam filter

Clean the foam filter with a little soft soap under running water and allow it to air-dry.

Storing



Ensure the Wet & Dry Vac has been fully emptied of any dry matter or liquid before it is stored.

Wrap the power cable around the cable hooks.

Keep all the accessories with the unit to avoid losing them.

Keep in a dry place out of reach of children.

DESCRIPTION OF SYMBOLS

V	Volts	Hz	Hertz
~	Alternating current	W	Watts
l	Litres		Double insulated
		l/s	Litres per second
	Read instruction manual		Warning
IP24	Ingress protection from water	mbar	Pressure rating (millibar)

SPARE PARTS

Spare parts can be ordered from the Special Orders Desk at your local Bunnings Warehouse or Homebase store.

For further information, or any parts visit www.ozito-diy.co.uk or contact Ozito Customer Service: Great Britain: 0151 294 4488
Ireland: 1850 882711
E-mail: enquires@ozito-diy.co.uk

ELECTRICAL SAFETY

WARNING! When using mains-powered tools, basic safety precautions, including the following, should always be followed to reduce risk of fire, electric shock, personal injury and material damage. Read the whole manual carefully and make sure you know how to switch the tool off in an emergency, before operating the tool. Save these instructions and other documents supplied with this tool for future reference. Before you connect the appliance to the mains supply make sure that the data on the rating plate are identical to the mains data. The appliance may only be connected to a shockproof socket.

 This tool is double insulated therefore no earth wire is required.

If the supply cord is damaged, it must be replaced by an electrician or a power tool repairer in order to avoid a hazard.
Note: Double insulation does not take the place of normal safety precautions when operating this tool. The insulation system is for added protection against injury resulting from a possible electrical insulation failure within the tool.

Using an Extension Lead
Always use an approved extension lead suitable for the power input of this tool. Before use, inspect the extension lead for signs of damage, wear and ageing. Replace the extension lead if damaged or defective.

When using an extension lead on a reel, always unwind the lead completely. Use of an extension lead not suitable for the power input of the tool or which is damaged or defective may result in a risk of fire and electric shock.

GENERAL POWER TOOL SAFETY WARNINGS

WARNING! Read all safety warnings and all instructions. Failure to follow the warnings and instructions may result in electric shock, fire and/or serious injury. Save all warnings and instructions for future reference. The term "power tool" in the warnings refers to your mains-operated (corded) power tool or battery-operated (cordless) power tool.

- Work area safety**
 - Keep work area clean and well lit. Cluttered or dark areas invite accidents.
 - Do not operate power tools in explosive atmospheres, such as in the presence of flammable liquids, gases or dust. Power tools create sparks which may ignite the dust or fumes.
 - Keep children and bystanders away while operating a power tool. Distractions can cause you to lose control.
- Electrical safety**
 - Power tool plugs must match the outlet. Never modify the plug in any way. Do not use any adapter plugs with earthed (grounded) power tools. Unmodified plugs and matching outlets will reduce risk of electric shock.
 - Avoid body contact with earthed or grounded surfaces, such as pipes, radiators, ranges and refrigerators. There is an increased risk of electric shock if your body is earthed or grounded.
 - Do not expose power tools to rain or wet conditions. Water entering a power tool will increase the risk of electric shock.
 - Do not abuse the cord. Never use the cord for carrying, pulling or unplugging the power tool. Keep cord away from heat, oil, sharp edges or moving parts. Damaged or entangled cords increase the risk of electric shock.
 - When operating a power tool outdoors, use an extension cord suitable for outdoor use. Use of a cord suitable for outdoor use reduces the risk of electric shock.
 - If operating a power tool in a damp location is unavoidable, use a residual current device (RCD) protected supply with a rated residual current of 30 mA or less. Use of an RCD reduces the risk of electric shock.
- Personal safety**
 - Stay alert, watch what you are doing and use common sense when operating a power tool. Do not use a power tool while you are tired or under the influence of drugs, alcohol or medication. A moment of inattention while operating power tools may result in serious personal injury.
 - Use personal protective equipment. Always wear eye protection. Protective equipment such as dust mask, non-slip safety shoes, hard hat, or hearing protection used for appropriate conditions will reduce personal injuries.

- Prevent unintentional starting. Ensure the switch is in the off-position before connecting to power source and/or battery pack, picking up or carrying the tool. Carrying power tools with your finger on the switch or energising power tools that have the switch on invites accidents.
- Remove any adjusting key or wrench before turning the power tool on. A wrench or a key left attached to a rotating part of the power tool may result in personal injury.
- Do not overreach. Keep proper footing and balance at all times. This enables better control of the power tool in unexpected situations.
- Dress properly. Do not wear loose clothing or jewellery. Keep your hair, clothing and gloves away from moving parts. Loose clothes, jewellery or long hair can be caught in moving parts. If devices are provided for the connection of dust extraction and collection facilities, ensure these are connected and properly used. Use of dust collection can reduce dust-related hazards.
- Power tool use and care
 - Do not force the power tool. Use the correct power tool for your application. The correct power tool will do the job better and safer at the rate for which it was designed.
 - Do not use the power tool if the switch does not turn it on and off. Any power tool that cannot be controlled with the switch is dangerous and must be repaired.
 - Disconnect the plug from the power source and/or the battery pack from the power tool before making any adjustments, changing accessories, or storing power tools. Such preventive safety measures reduce the risk of starting the power tool accidentally.
 - Store idle power tools out of the reach of children and do not allow persons unfamiliar with the power tool or these instructions to operate the power tool. Power tools are dangerous in the hands of untrained users.
 - Maintain power tools. Check for misalignment or binding of moving parts, breakage of parts and any other condition that may affect the power tool's operation. If damaged, have the power tool repaired before use. Many accidents are caused by poorly maintained power tools.
 - Keep cutting tools sharp and clean. Properly maintained cutting tools with sharp cutting edges are less likely to bind and are easier to control.
- Use the power tool, accessories and tool bits etc. in accordance with these instructions, taking into account the working conditions and the work to be performed. Use of the power tool for operations different from those intended could result in a hazardous situation.
- Service
 - Have your power tool serviced by a qualified repair person using only identical replacement parts. This will ensure that the safety of the power tool is maintained.
 - If the supply cord is damaged, it must be replaced by the manufacturer, its service agent or similarly qualified persons in order to avoid a hazard.

WET & DRY VACUUM SAFETY WARNINGS

IMPORTANT! When using the equipment, a few safety precautions must be observed to avoid injuries and damage. Please read the complete operating manual with due care. Keep this manual in a safe place so that the information is available at all times. If you give the equipment to any other person, give them these operating instructions as well.

We cannot accept any liability for damage or accidents which arise due to a failure to follow these instructions and the safety information.

- Do not leave appliance unattended when plugged in. Unplug from outlet when not in use and before servicing and cleaning.
- To avoid electric shock, do not expose to rain. Store indoors.
- Never use in the presence of explosive liquids, vapours or explosive dust – such as coal or grain.
- Never pick up asbestos or asbestos dust.
- Wood dust and chips in a confined area can give rise to fire or an explosion. Guard against possible ignition sources.
- Do not pick up anything that is burning or smouldering – such as metal grinding dust, cigarette ends, hot coals, matches or similar.
- The appliance is not intended for use by young children or infirm persons without supervision. Young children should be supervised to ensure they do not play with the appliance.
- Use only manufacturer's recommended attachments and consumables.
- Never modify the cleaner in any way - this is dangerous and will invalidate the warranty.
- Do not use cleaner without the filter in place.
- If motor sound becomes higher pitched always check for the following:
 - Blocked hose or accessory.
 - Blocked filter.
 - Full container.
- Never try to move the cleaner by pulling with the mains lead.
- Always check that the filter is clear and not blocked. Keep all openings clear of any blockages.
- When lifting the unit, always lift it with the handle or under rim of bucket. Beware of excess weight.
- Always switch the unit off before changing attachments or connecting different power tools.
- Always disconnect equipment from the appliance when it is not in use.
- If the cordset is damaged have it repaired by an authorised service centre.
- This appliance is not intended for use by persons (including children) with reduced physical, sensory or mental capabilities, or lack of experience and knowledge, unless they have been given supervision or instruction concerning use of the appliance by a person responsible for their safety.
- Children should be supervised to ensure that they do not play with the appliance.
- The wet and dry vacuum cleaner is designed for wet and dry vacuuming using the appropriate filter. The appliance is not suitable for the vacuuming of combustible, explosive or harmful substances.
- The equipment is to be used only for its prescribed purpose. Any other use is deemed to be a case of misuse. The user / operator and not the manufacturer will be liable for any damage or injuries of any kind caused as a result of this.

ozito

WET & DRY VACUUM

1250W 20l

ORIGINAL INSTRUCTION

SPECIFICATIONS

Input Power:	1250W
Suction Power Max.:	180 mbar
Air Flow:	68 l/s
Tank Capacity:	20 l
IP Rating:	IP24
Product weight:	4.7 kg

ozito-diy.co.uk

3

YEAR REPLACEMENT WARRANTY

WHAT'S IN THE BOX

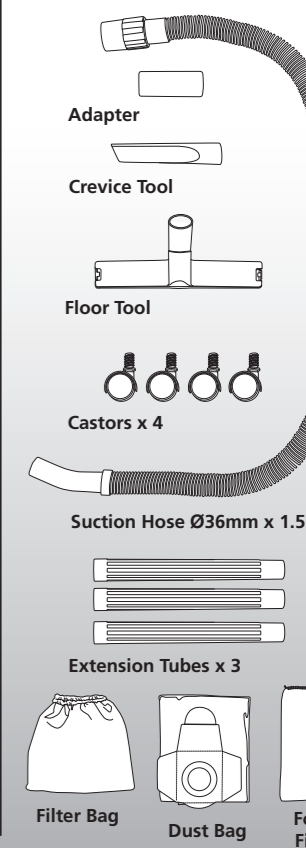

WARRANTY

All of our products undergo strict quality checks to ensure that they reach you in perfect condition. In the unlikely event that your device develops a fault, please contact our service department at the address shown on this guarantee card. You can also contact us by telephone using the customer service number shown. Please note the following terms under which guarantee claims can be made:

1. These warranty terms regulate additional warranty services, which the manufacturer mentioned below promises to buyers of its new products in addition to their statutory guarantee claims are not affected by this guarantee. Our guarantee is free of charge to you.

2. The warranty services only covers defects due to material or manufacturing faults on a product which you have bought from the manufacturer mentioned below are limited to either the rectification of said defects on the product or the replacement of the product, whichever we prefer. Please note that our devices are not designed for use in commercial, trade or professional applications. A guarantee contract will not be created if the device has been used by commercial, trade or industrial business or has been exposed to similar stresses during the guarantee period.

3. The following are not covered by our guarantee:
- Damage to the device caused by a failure to follow the assembly instructions or due to incorrect installation, a failure to follow the operating instructions (for example connecting it to an incorrect mains voltage or current type) or a failure to follow the maintenance and safety instructions or by exposing the device to abnormal environmental conditions or by lack of care and maintenance.
- Damage to the device caused by abuse or incorrect use (for example overloading the device or the use of unapproved tools or accessories), ingress of foreign bodies into the device (such as sand, stones or dust, transport damage), the use of force or damage caused by external forces (for example by dropping it).
- Damage to the device or parts of the device caused by normal or natural wear or tear or by normal use of the device.

4. Your Product is guaranteed for a period of 36 months from the original date of purchase and is intended for DIY (Do It Yourself) use only. Warranty excludes consumable parts. Guarantee claims should be submitted before the end of the guarantee period within two weeks of the defect being noticed. No guarantee claims will be accepted after the end of the guarantee period. The original guarantee period remains applicable to the device even if repairs are carried out or parts are replaced. In such cases, the work performed or parts fitted will not result in an extension of the guarantee period, and no new guarantee will become active for the work performed or parts fitted. This also applies if an on-site service is used.

IN ORDER TO MAKE A CLAIM UNDER THIS WARRANTY YOU MUST RETURN THE PRODUCT TO THE PLACE OF PURCHASE WITH YOUR REGISTER RECEIPT.

Please refer to the restrictions of this warranty concerning wearing parts, consumables and missing parts as set out in the service information in these operating instructions.

CUSTOMER SERVICE HELPLINE
GB: 0151 294 4488
IRL: 1850 882711
Ozito-diy.co.uk

KNOW YOUR PRODUCT

WET & DRY VACUUM

- | | |
|--------------------|-------------------------|
| 1. Handle | 8. Motor Securing Clips |
| 2. Motor | 9. Vacuum Inlet |
| 3. Suction Hose | 10. Tank |
| 4. Extension Tubes | 11. Adapter |
| 5. Filter Basket | 12. Blow Outlet |
| 6. Safety Float | 13. Castors |
| 7. On/Off Switch | 14. Floor Tool |

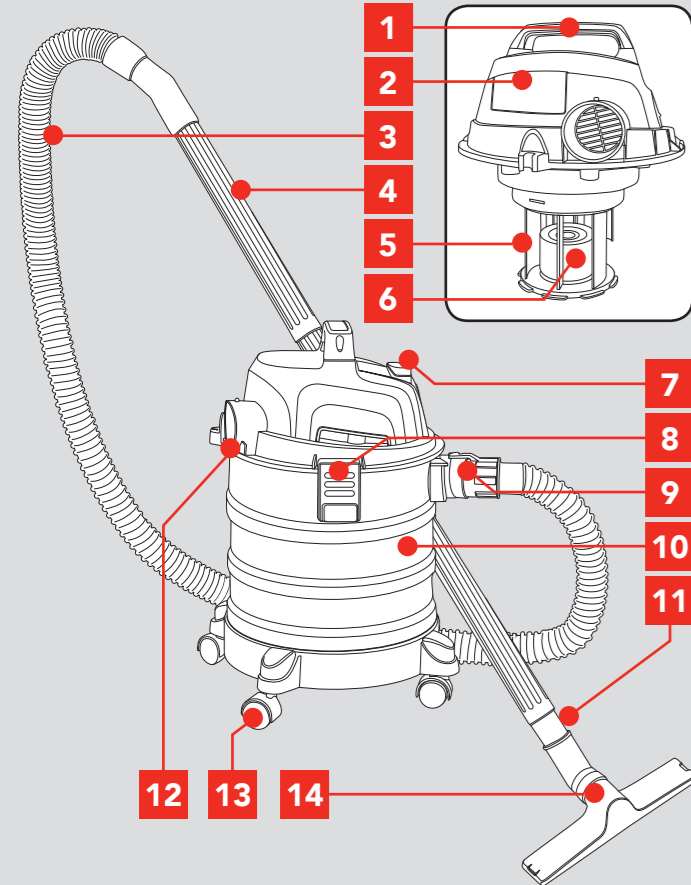

ACCESSORIES

- | | |
|-----------------|------------------|
| 15. Filter Bag | 18. Crevice Tool |
| 16. Dust Bag | 19. Cable Hook |
| 17. Foam Filter | |

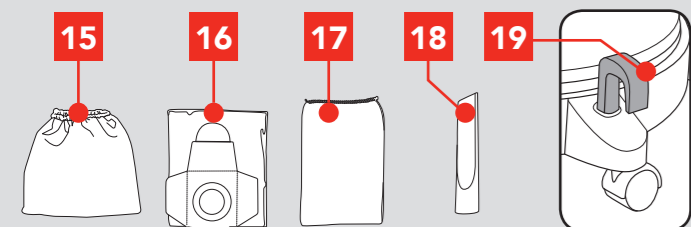

ONLINE MANUAL

Scan this QR Code with your mobile device to take you to the online manual.



SETUP & PREPARATION

1. ASSEMBLY

Assembling the Castors

- Turn the container upside down.
- Insert the castor assemblies into the base of the tank.

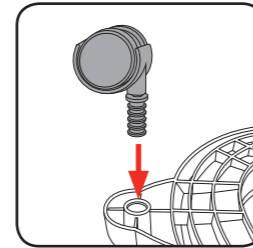
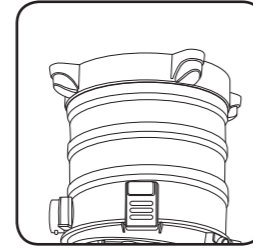

Fitting the Motor

- When fitting the motor to the tank, position it so that the motor securing clips on the tank align with the fastening points on the motor.
- Fasten the motor securing clips to the motor, making sure that they lock into place correctly.
- To remove the motor, open the motor securing clip and lift the motor out of the tank.

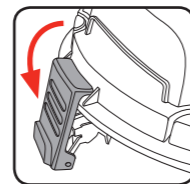
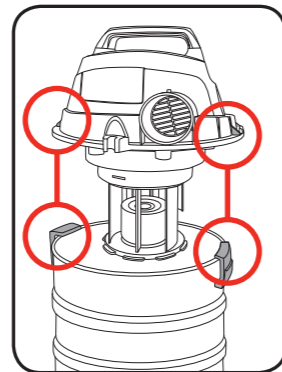

Fitting the Handle

- Align the holes on either side of the handle with the holes in the top side of the motor.
- Insert two screws (supplied) into the handle and tighten with a screwdriver (not supplied).

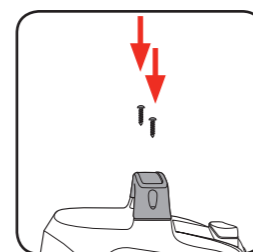
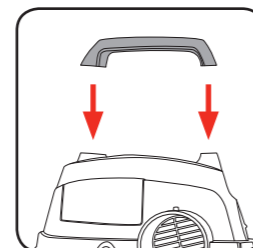

Mounting the Cable Hook

- Press the cable hook for the cable store into the mount on the base of the unit.
- After use, the power cable can be conveniently wound onto the cable hooks.

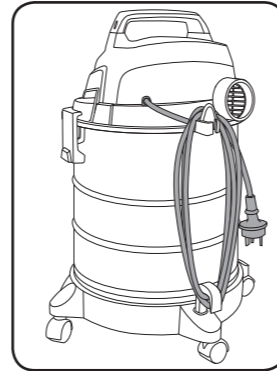
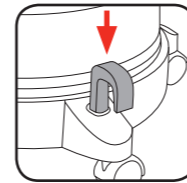

Fitting the Dust Bag

- For vacuuming fine, dry dirt it is recommended that you fit the dust bag. The dust bag is suitable for dry vacuuming only. Using the dust bag makes it easier to dispose of the dust that has been collected.
- To attach, slip the dust bag over the vacuum inlet.

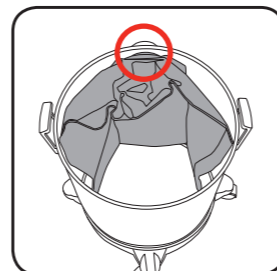
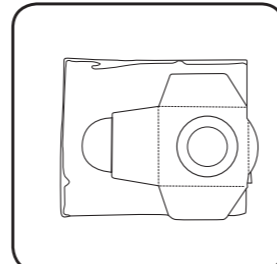

2. FITTING THE FILTER

IMPORTANT! NEVER USE THE WET AND DRY VACUUM CLEANER WITHOUT A FILTER! ALWAYS ENSURE THAT THE FILTERS ARE PERFECTLY SECURE!

Fitting the Foam Filter - Vacuuming Liquid

For wet-vacuuming, slip the supplied foam filter over the filter basket.

NOTE: Do not use the filter bag and/or dust bag when vacuuming liquid

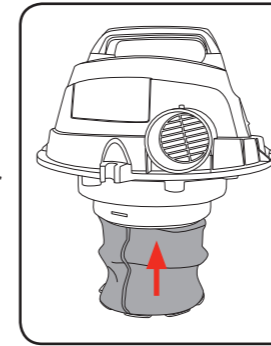

Fitting the Filter Bag - Vacuuming Dry Matter

For dry vacuum cleaning always use the filter bag. Mount the filter bag, so that no air is sucked through the filter cage without being filtered.

NOTE: Do not use the foam filter when vacuuming dry matter.

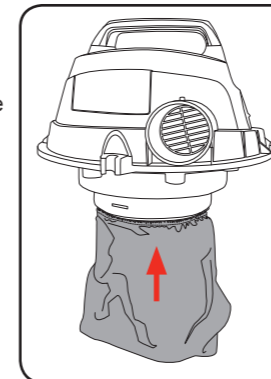

3. FITTING HOSES & NOZZLES

Connect the suction hose to the corresponding connector on the wet and dry vacuum, depending on the application required:

Vacuuming

Connect the suction hose to the vacuum inlet

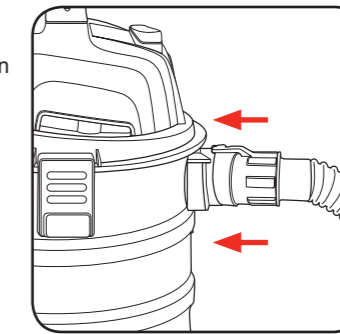

Blowing

Connect the suction hose to the blow outlet.

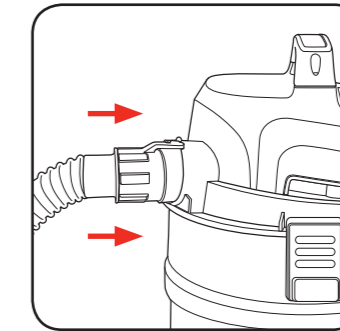

Extension Tube and Adaptor

- The suction hose can be extended by attaching one or more sections of the 3 part extension tubes.

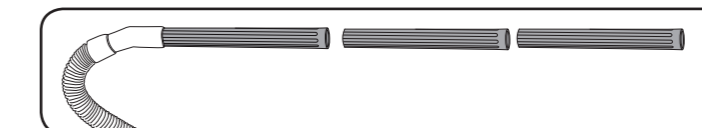

- The adaptor must be inserted between the extension tube and whichever of the nozzles is required.

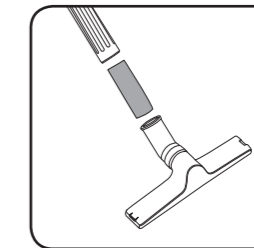

Suction Tools

Floor Tool

The floor tool is for vacuuming solids and liquids over medium to large areas.

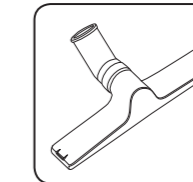

Crevice Tool

The crevice tool is designed for cleaning crevices and edges.

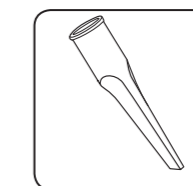

OPERATION

4. OPERATION

This vacuum must be used with a residual current device with a rated residual current of 30mA or less.

IMPORTANT! SWITCH OFF THE EQUIPMENT IF LIQUID OR FOAM IS EMITTED WITH THE EXHAUST AIR WHEN WET VACUUM CLEANING.

On/Off Switch

Switch position 0: OFF
Switch position I: ON

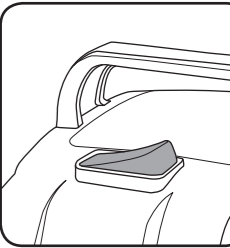

Dry Vacuuming

Use the dust bag and the filter bag for dry vacuuming (see 2. Fitting the Filter). Check that the filter is securely fitted at all times.

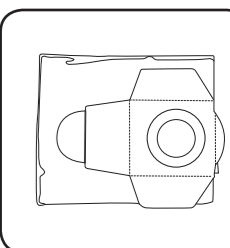

Wet Vacuuming

For wet-vacuuming, use the foam filter (see 2. Fitting the Filter). Check that the filter is securely fitted at all times.

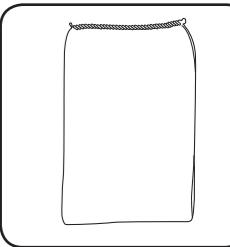

IMPORTANT! WHEN WET VACUUMING, THE SAFETY FLOAT TURNS OFF THE WET AND DRY VACUUM CLEANER AUTOMATICALLY WHEN THE MAXIMUM LEVEL IS REACHED.

IMPORTANT! THE WET AND DRY VACUUM CLEANER IS NOT SUITABLE FOR THE VACUUMING OF COMBUSTIBLE LIQUIDS.

Blowing

Connect the suction hose to the blow outlet on the wet and dry vacuum cleaner.

