

## MAINTENANCE

- When not in use, the drill should be stored in a dry, frost free location, keep out of children's reach.
- Keep ventilation slots of the drill clean at all times and prevent anything from entering.
- If the housing of the drill requires cleaning, do not use solvents. Use of a cloth only is recommended.
- Blow out the ventilation slots with compressed air periodically.

**Note:** Ozito Industries will not be responsible for any damage or injuries caused by repair of the drill by an unauthorised person or by mishandling.

## TROUBLESHOOTING

### LED lights do not illuminate on charger

Check the charging adaptor is securely plugged into the wall outlet.

Check the battery is firmly connected to the charging cradle.

Check that the charging jack is securely connected to the charging cradle.

### Variable speed trigger is locked

Ensure that the forward / reverse lever is in the correct position; pressed left for forwards direction, pressed right for backwards direction. If it is in between the two settings the variable speed trigger will be locked.

### The drill is stripping the screw head

Ensure you are starting with a low torque setting and holding the drill securely onto the screw head. Increase the torque setting as required.

### Drill has cut out during use

The battery charge could be completely depleted. Place the battery on the charging cradle for 3-5 hours.

### Battery protection system

The tool is equipped with the battery protection system, which helps to ensure a long service life.

The output power automatically cuts off during operation when the tool and/or battery are placed under the following situations:

#### • When the tool is overloaded:

If this occurs, release the trigger switch and remove causes of overload, then pull the switch trigger again to restart.

#### • When the remaining battery capacity becomes low:

Recharge the battery pack.

**Note:** The battery protection system does not in any way damage the tool.

**Note:** The indicated capacity may be lower than the actual level during use or immediately after using the tool.

## SPARE PARTS

Spare parts can be ordered from the Special Orders Desk at your local Bunnings Warehouse.

For further information, or any parts not listed here, visit

[www.ozito-diy.co.uk](http://www.ozito-diy.co.uk) or contact Ozito Customer Service:

GB: 0151 294 4488

IRL: 1850 882711

E-mail: [info@ozito-diy.co.uk](mailto:info@ozito-diy.co.uk)

## BATTERY AND CHARGER SAFETY WARNINGS

**!** THIS MANUAL CONTAINS IMPORTANT SAFETY AND OPERATING INSTRUCTIONS FOR YOUR BATTERY CHARGER.

- Before using the charger read all instructions and cautionary markings on the charger, battery pack and the product using the battery pack.
- This charger is not intended for any uses other than charging rechargeable batteries. Any other use may result in risk of fire, electric shock or electrocution.
- Do not place any object on top of the charger or place the charger on a soft surface that may result in excessive internal heat. Place the charger in a position away from any heat source.
- To reduce risk of damage to the electric plug and cord, pull by the plug rather than the cord when disconnecting the charger.
- Make sure the cord is located so that it will not be stepped on, tripped over, or otherwise subjected to damage or stress.
- An extension cord should not be used unless absolutely necessary. Use of an improper extension cord could result in the risk of fire, electric shock or electrocution.
- Do not operate the charger if it has received a sharp blow, been dropped or otherwise damaged in any way. Have it checked by an electrician or power tool repairer.
- Do not disassemble charger. Take it to an electrician or power tool repairer when service or repair is required. Incorrect reassembly may result in a risk of electric shock, electrocution or fire.
- To reduce risk of electric shock, unplug the charger from the outlet before attempting any cleaning. Removing the battery pack will not reduce this risk.
- Never attempt to connect 2 chargers together.
- DO NOT store or use the tool and battery pack in locations where the temperature may reach or exceed 40°C (such as inside sheds or metal buildings in summer).
- The charger is designed to operate on standard household electrical power (240 Volts). Do not attempt to use it on any other voltage!
- The battery pack is not fully charged out of the carton. First read the safety instructions and then follow the charging notes and procedures.
- The longest life and best performance can be obtained if the battery pack is charged when the air temperature is between 18 - 24°C. Do not charge the battery pack in an air temperature below 10°C or above 40°C. This is important and will prevent damage to the battery pack.
- Do not incinerate the battery pack even if it is seriously damaged or is completely worn out. The battery can explode in a fire.
- Never attempt to open the battery pack for any reason. If the plastic housing of the battery pack breaks or cracks, immediately discontinue use and do not recharge.
- During charging, the battery must be placed in a well ventilated area.

## DESCRIPTION OF SYMBOLS

V	Volts	Hz	Hertz
ac/~	Alternating current	W	Watts
dc/—	Direct current	Ø	Diameter
mA	Milliamperes	Ah	Amp hour
Nm	Newton Meters	No	No load speed
/min	Revolutions or reciprocation per minute		
	Warning		Read instruction manual
	Double insulated		Indoor use only
	Thermal cut-out protection		Polarity
	Lithium Ion battery		Do not use or store battery in temperatures exceeding 50°C
	Recycle battery		Do not put in the rubbish
	Do not incinerate		Do not get battery wet

## ELECTRICAL SAFETY

**!** **WARNING!** When using mains-powered tools, basic safety precautions, including the following, should always be followed to reduce risk of fire, electric shock, personal injury and material damage.

Read the whole manual carefully and make sure you know how to switch the tool off in an emergency, before operating the tool.

Save these instructions and other documents supplied with this tool for future reference.

Before you connect the charger to the mains supply make sure that the data on the rating plate are identical to the mains data.

This tools charger is double insulated, therefore no earth wire is required.

If the supply cord is damaged, it must be replaced by an electrician or a power tool repairer in order to avoid a hazard.

**Note:** Double insulation does not take the place of normal safety precautions when operating this tool. The insulation system is for added protection against injury resulting from a possible electrical insulation failure within the tool.

The power supply for this products charger should be protected by a residual current device (rated at 30mA or less). A residual current device reduces the risk of electric shock.

## GENERAL POWER TOOL SAFETY WARNINGS

**!** **WARNING!** Read all the safety information, instructions, illustrations and technical data provided on or with this power tool. Failure to adhere to the following instructions may result in electric shock, fire and/or serious injury. Keep all the safety information and instructions in a safe place for future use.

The term „power tool“ used in the safety information and instructions refers to power tools operated from the mains power supply (with a power cable) and to battery operated power tools (without a power cable).

### 1. Workplace safety

a) **Keep your work area clean and well illuminated.** Untidy or unlit work areas can result in accidents.

b) **Do not operate the electric tool in an environment where there is a risk of explosions and where there are inflammable liquids, gases or dust.** Electric tools produce sparks which could set the dust or vapours alight.

c) **Keep children and other people away from the power tool while you are using it.** If you are distracted you may lose control of the power tool.

### 2. Electrical safety

a) **The connector plug from this electric tool must fit into the socket. The plug should never be altered in any way. Never use adapter plugs together with earthed electric tools.** Unaltered plugs and correct sockets reduce the risk of an electric shock.

b) **Avoid bodily contact with earthed surfaces such as pipes, heating, ovens and fridges.** The risk of electric shock is increased if your body is earthed.

c) **Keep the tool out of the rain and away from moisture.** The ingress of water into an electric tool increases the risk of an electric shock.

d) **Do not use the power cable for a purpose for which it is not designed, for example to carry the power tool, hang it up or to pull the plug out of the socket. Keep the power cable away from heat, oil, sharp edges and moving parts.** Power cables that are damaged or tangled increase the risk of an electric shock.

e) **If you use an electric power tool outdoors, use only extension cables that are suitable for outdoor use.** The use of an extension cable which is suitable for outdoor use reduces the risk of an electric shock.

f) **If operation of the electric tool in a damp environment can not be avoided, use a earth-leakage circuit-breaker.** The earth-leakage circuit-breaker reduces the risk of an electric shock.

### 3. Safety of persons

a) **Be careful, watch what you are doing and use an electric tool sensibly. Do not use the tool if you are tired or under the influence of drugs, alcohol or medication.** A moment of inattention when using the electric tool can result in serious injuries.

b) **Wear personal protection equipment and always wear safety goggles.** Wearing personal protection (such as dust masks, non-slip safety shoes, safety helmet or ear protection, depending upon the type and use of the electric tool) reduces the risk of injury.

c) **Make sure that the appliance cannot start up accidentally. Ensure that the electric tool is switched off before you connect it to the power supply and/or insert the battery, or pick up or carry the tool.** If your finger is on the switch whilst carrying the electric tool or if you connect the appliance to the mains when it is switched on, this can lead to accidents.

d) **Remove all adjusting tools or wrenches before you switch on the power tool. Any tool or wrench in a rotating part of the power tool could cause injuries.**

e) **Avoid abnormal working postures. Make sure you stand squarely and keep your balance at all times.** This will enable you to control the power tool better in unexpected situations.

f) **Wear suitable clothes. Never wear loose fitting clothes or jewelry.** Keep hair, clothing and gloves away from moving parts. Loose clothing, jewelry or long hair can be caught by moving parts.

g) **If dust extraction devices and dust collection devices can be fitted, they must be connected and must be used correctly.** The use of a dust extractor can reduce the dangers posed by dust.

h) **Do not allow yourself to be lulled into a false sense of security and do not**

ignore the safety regulations covering electric power tools, even if you are familiar with the power tool after having used it many times. Carelessness can lead to serious injuries in just a fraction of a second.

### 4. Using and handling the power tool

a) **Do not overload your power tool. Use the correct electric tool for the job in hand.** The correct tool will enable you to work better and more safely within the specific performance range.

b) **Do not use an electric power tool if the switch is defective.** An electric power tool that cannot be switched on or off is dangerous and must be repaired.

c) **Pull the plug out of the socket and/or remove the battery pack before making any adjustments to the tool, changing accessories or putting the power tool down.** These precautions will prevent the power tool starting accidentally.

d) **Keep unused electric tools out of the reach of children. Do not allow people who are not familiar with the power tool or who have not read these instructions to use the tool.** Electric tools are dangerous if they are used by inexperienced people.

e) **Look after power tools plug-in tools with care. Check that moving parts function correctly and do not jam, and whether any parts are broken or damaged such that they adversely affect the function of the power tool. Have damaged parts repaired before you use the power tool.** Many accidents are caused by poorly maintained electric tools.

f) **Keep cutting tools sharp and clean.** Carefully maintained cutting tools with sharp cutting edges will jam less and are easier to control.

g) **Use the power tool, accessories, plug-in tools, etc. as set out in these instructions. Take account of the conditions in your work area and the job in hand.** Using electric tools for purposes other than the one for which they are designed can result in dangerous situations.

h) **Keep the handles and grip surfaces dry, clean and free from oil and grease.** If the handles and grip surfaces are slippery, it will not be possible to operate and control the power tool safely in unforeseen situations.

### 5. Using and handling the cordless tool

a) **Only charge the batteries in chargers that are recommended by the manufacturer.** A charger that is designed for a certain type of battery may pose a fire risk if it is used with other types of battery.

b) **Use only the correct batteries in the electric tools.** The use of other batteries may result in injuries and a fire risk.

c) **Keep unused batteries away from paper clips, coins, keys, nails, screws and other metallic objects that could cause a short circuit between the contacts.** A short circuit between the battery contacts may cause burns or a fire.

d) **In case of incorrect use, fluid may escape from the battery. Avoid contact with it. If you touch it by accident, rinse the affected area with water. If you get the fluid in your eyes, also seek medical advice.** Leaking battery fluid can cause skin irritation or burns.

e) **Never use damaged or altered rechargeable batteries.** Damaged or altered rechargeable batteries can behave unpredictably and lead to a risk of fire, explosion or injury.

f) **Never expose a rechargeable battery to fire or high temperatures.** Fire or temperatures over 130°C pose a risk of explosion.

g) **Follow all the instructions on charging and never charge the rechargeable battery or cordless tool outside the specified allowable charging temperature range.** Incorrect charging or charging outside the allowable charging temperature range could cause irreparable damage to the battery and increase the risk of fire.

### 6. Service

a) **Have your electric tool repaired only by trained personnel using only genuine spare parts.** This will ensure that your electric tool remains safe to use.

b) **Never perform maintenance work on damaged rechargeable batteries.** All maintenance work on rechargeable batteries should only be performed by the manufacturer or authorized after sales service outlets.



18V LITHIUM ION

## BRUSHLESS DRILL DRIVER

### ORIGINAL INSTRUCTIONS

### SPECIFICATIONS

Input: 18V  
Chuck Size: 13mm Keyless  
No Load Speed: 0-400 / 0-1,500/min  
Torque Setting: 21  
Max. Torque: 40Nm  
Max. Drilling Ø: 32mm Wood  
10mm Metal

Weight: 1.1kg

[ozito-diy.co.uk](http://ozito-diy.co.uk)

5 YEAR  
REPLACEMENT WARRANTY

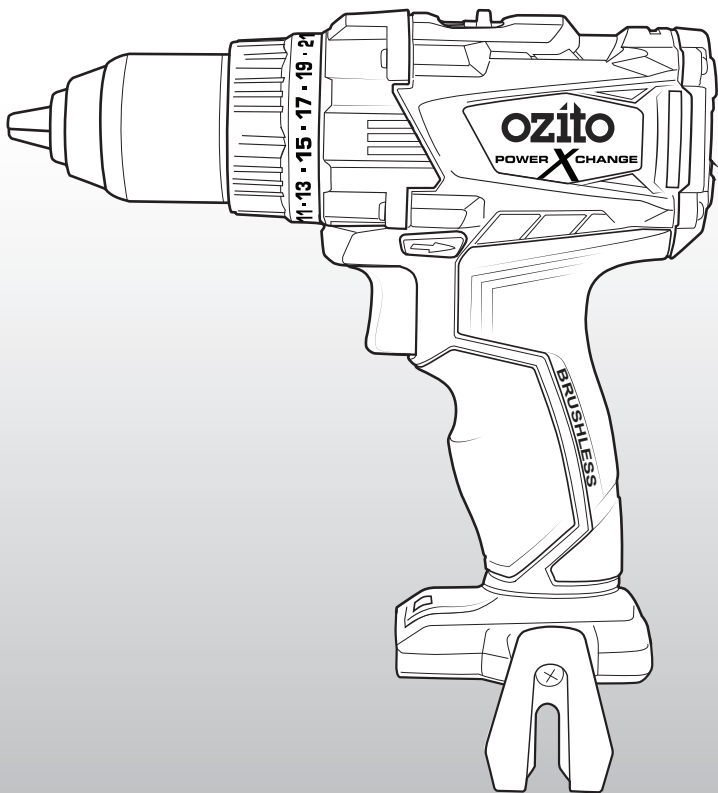

### WHAT'S IN THE BOX

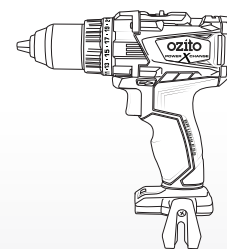

Brushless Drill Driver

PXBDS-220U

## WARRANTY

All of our products undergo strict quality checks to ensure that they reach you in perfect condition. In the unlikely event that your device develops a fault, please contact our service department at the address shown on this guarantee card. You can also contact us by telephone using the customer service number shown. Please note the following terms under which guarantee claims can be made:

1. These warranty terms regulate additional warranty services, which the manufacturer mentioned below promises to buyers of its new products in addition to their statutory guarantee claims are not affected by this guarantee. Our guarantee is free of charge to you.

2. The warranty services only covers defects due to material or manufacturing faults on a product which you have bought from the manufacturer mentioned below are limited to either the rectification of said defects on the product or the replacement of the product, whichever we prefer.

Please note that our devices are not designed for use in commercial, trade or professional applications. A guarantee contract will not be created if the device has been used by commercial, trade or industrial business or has been exposed to similar stresses during the guarantee period.

3. The following are not covered by our guarantee:

- Damage to the device caused by a failure to follow the assembly instructions or due to incorrect installation, a failure to follow the operating instructions (for example connecting it to an incorrect mains voltage or current type) or a failure to follow the maintenance and safety instructions or by exposing the device to abnormal environmental conditions or by lack of care and maintenance.

- Damage to the device caused by abuse or incorrect use (for example overloading the device or the use of unapproved tools or accessories), ingress of foreign bodies into the device (such as sand, stones or dust, transport damage), the use of force or damage caused by external forces (for example by dropping it).

- Damage to the device or parts of the device caused by normal or natural wear or tear or by normal use of the device.

4. Your Product is guaranteed for a period of 60 months from the original date of purchase and is intended for DIY (Do It Yourself) use only. Lithium Ion batteries and chargers are covered by a 12 month warranty. Warranty excludes consumable parts, for example: grinding discs. Guarantee claims should be submitted before the end of the guarantee period within two weeks of the defect being noticed. No guarantee claims will be accepted after the end of the guarantee period. The original guarantee period remains applicable to the device even if repairs are carried out or parts are replaced. In such cases, the work performed or parts fitted will not result in an extension of the guarantee period, and no new guarantee will become active for the work performed or parts fitted. This also applies if an on-site service is used.

IN ORDER TO MAKE A CLAIM UNDER THIS WARRANTY YOU MUST RETURN THE PRODUCT TO THE PLACE OF PURCHASE WITH YOUR REGISTER RECEIPT.

Please refer to the restrictions of this warranty concerning wearing parts, consumables and missing parts as set out in the service information in these operating instructions.

CUSTOMER SERVICE HELPLINE

GB: 0151 294 4488

IRL: 1850 882711

Ozito-diy.co.uk



## KNOW YOUR PRODUCT

### BRUSHLESS DRILL DRIVER

- 1 Metal Ratcheting Chuck
- 2 Torque Adjustment Collar
- 3 Variable Speed Trigger
- 4 Forward/ Reverse Lever
- 5 LED Light
- 6 Battery Seating
- 7 Belt Clip
- 8 Sure Grip Handle
- 9 Gear Selector

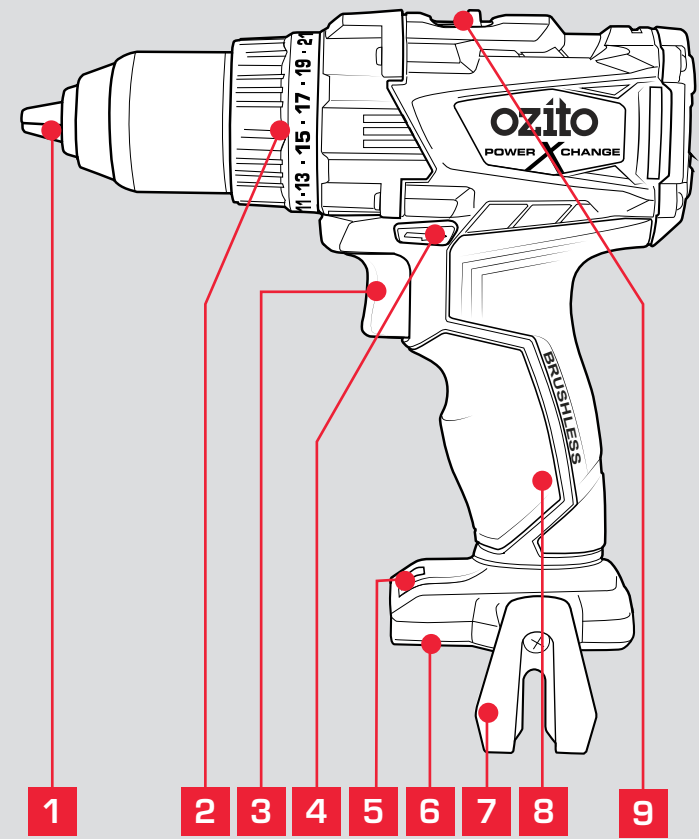

### BATTERY & CHARGER (sold separately)

This tool is compatible with all battery and chargers from the Ozito Power X Change Range.

**ONLINE MANUAL**  
Scan this QR Code with your mobile device to take you to the online manual.



## SETUP & PREPARATION

### 1. BATTERY & CHARGING

**CAUTION** THE CHARGER FOR THIS PRODUCT SHOULD BE PROTECTED BY A RESIDUAL CURRENT DEVICE (RATED AT 30mA OR LESS).

The purchased battery will be shipped in a low charge condition, and requires charging prior to use. Allow several cycles of charging and discharging (through use of the tool) for the battery to reach its optimum performance / runtime.

#### Charging your lithium ion battery - Fast Charger

- 1 Connect the charger into a mains power outlet.

The charger LED will flash green showing power is being supplied to the charger.

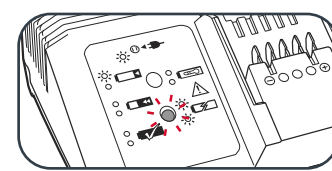

- 3 With the charger sitting on a flat surface, align the raised ribs on the battery with the recess in the charger and slide onto the charger ensuring a firm connection.

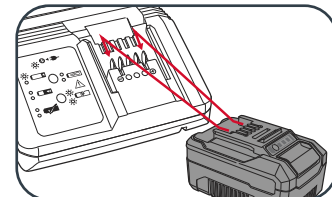

- 4 The charger LED will illuminate red signifying that the battery is charging.

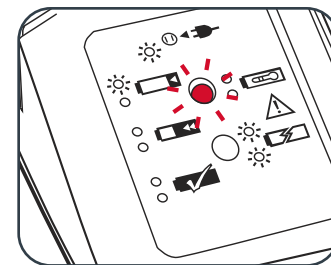

- 5 The charger LED will illuminate green once the battery is charged.

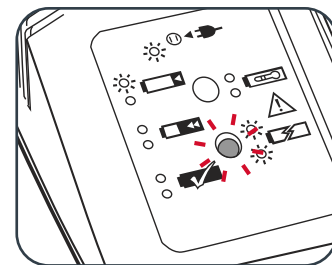

#### Charger LED Indicator

LED Indicator	Situation
GREEN (Flashing)	Stand By (no battery pack is inserted)
RED (Flashing)	Battery is charging (low charge)
RED (Illuminated)	Battery is charging (mid charge)
GREEN (Illuminated)	Battery is 85% - 100% charged and ready for use
BOTH (Illuminated)	Battery pack is too hot or too cold (charging will begin automatically when battery reaches correct charging temperature).
BOTH (Flashing)	Defective battery. Never charge a defective battery pack! Remove battery pack from charger.

#### Charging your lithium ion battery - Eco Charger

- 1 Connect the charger into a mains power outlet.

- 2 The charger LED will flash green showing power is being supplied to the charger.

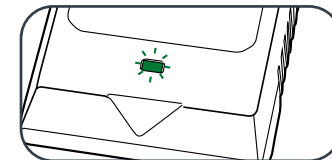

- 3 With the battery sitting on a flat surface, align the raised ribs on the battery with the recess in the charger and slide onto the battery ensuring a firm connection.

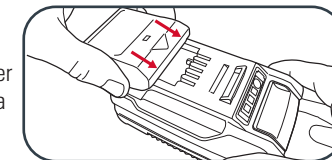

- 4 The charger LED will illuminate red signifying that the battery is charging.

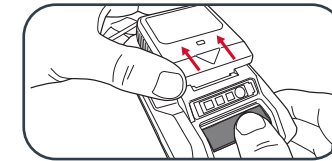

- 5 When removing the charger from the battery, first press the battery release tab, then slide the charger from its position.

#### Charger LED Indicator

LED Indicator	Situation
GREEN (Flashing)	Stand By (no battery pack is inserted)
RED (Illuminated)	Battery is charging (low charge)
GREEN (Illuminated)	Battery is Charged and ready for use
RED (Flashing)	Battery or Charger fault
RED & GREEN (Flashing)	Battery pack is too hot or too cold (remove battery from charger and store at room temperature 20°C. Insert battery again when at correct charging temperature). If this happens again, the battery is defective and needs to be replaced.

#### Battery Charge Indicator

The purchased battery is equipped with a battery charge indicator to show the state of the battery charge. Press the charge indicator button and look to see which LED lights.

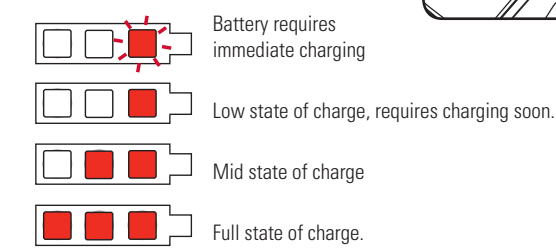

**Note:** The battery needs to be removed from the tool to check the state of charge.

### 2. BATTERY INSTALLATION

#### Installing the Battery Pack

- 1 Slide the battery into the drill base until it clicks into place.

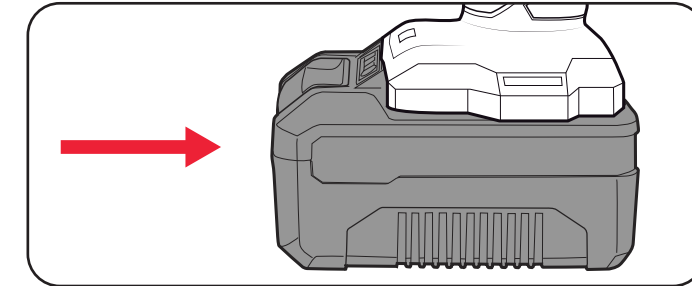

#### Removing the Battery Pack

- 1 Hold down the battery release button.

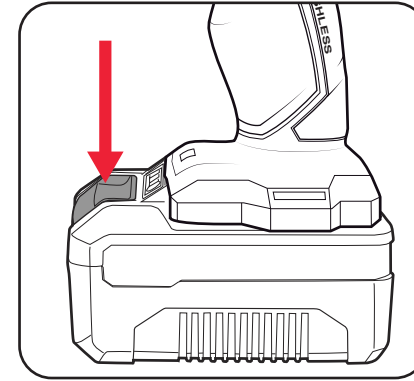

- 2 Slide the battery out.

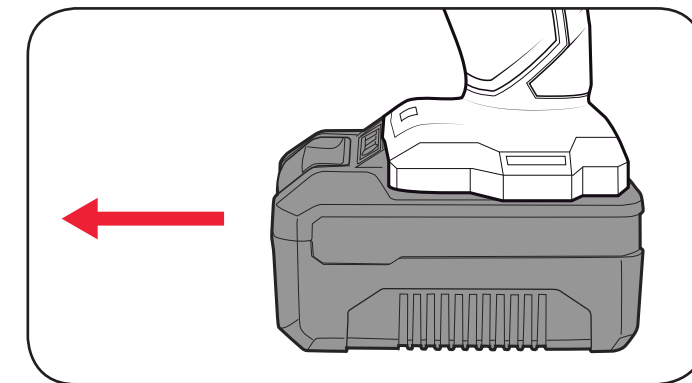

### 3. KEYLESS CHUCK

**CAUTION** ENSURE THE TOOL IS SWITCHED OFF AND DISCONNECTED FROM THE POWER SUPPLY BEFORE PERFORMING ANY OF THE FOLLOWING TASKS.

#### Installing a Drill Bit

- 1 Rotate the chuck collar anti-clockwise to open the chuck.

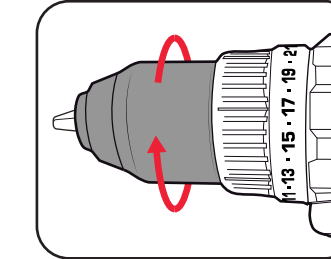

- 2 Insert the drill bit, making sure it is centred in the chuck.

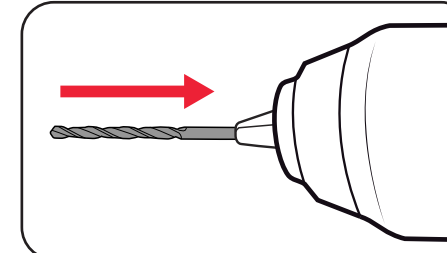

- 3 Tighten the chuck by turning clockwise.

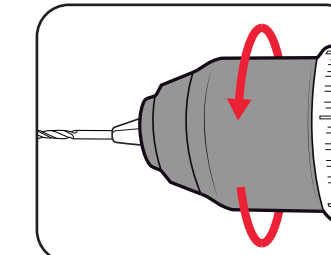

- 4 Pull on the bit to ensure it is firmly secured.

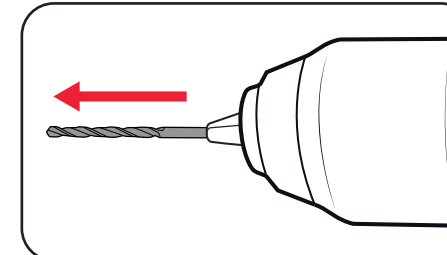

#### Removing a Drill Bit

- 1 Open the chuck by rotating the chuck collar and remove the drill bit.

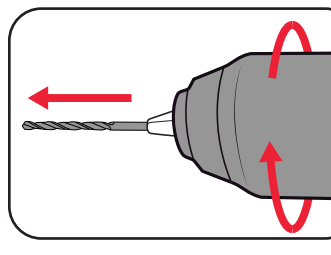

## OPERATION

### 4. CONTROLS

#### Forward/ Reverse Lever

- 1 For forward rotation, push the fwd/rev lever towards the left side of the drill. For reverse rotation push fwd/rev lever to the right.

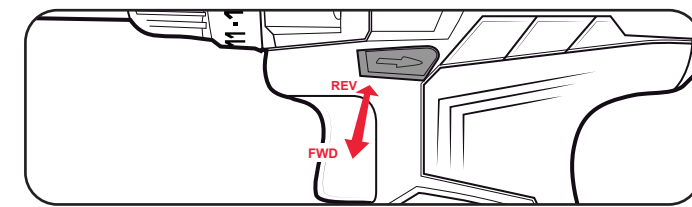

#### Variable Speed Trigger

- 1 To start drilling squeeze the variable speed trigger.
- 2 To stop drilling release the trigger.

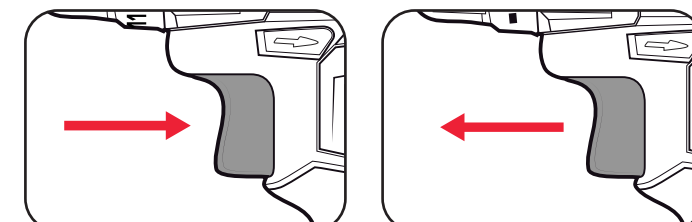

**Note:** The more the variable speed trigger is depressed, the faster the drill bit will rotate.

#### Adjusting Torque

- 1 Rotate the torque collar to the desired setting.

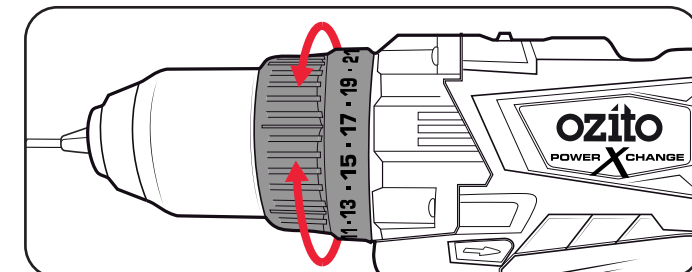

**Note:** Selecting a higher torque setting will allow the drill to use more torque to drive the screw in or out. To prevent damaging the screw head, it is recommended to start at a low torque setting and increase when necessary.

#### Speed Control

The gear selector controls the speed of the drill. First gear allows slower drilling with more torque, while second gear is suitable when less torque but higher speed is required.

- 1 Slide the switch forward to select first gear.
- 2 Slide the switch backward to select second gear.

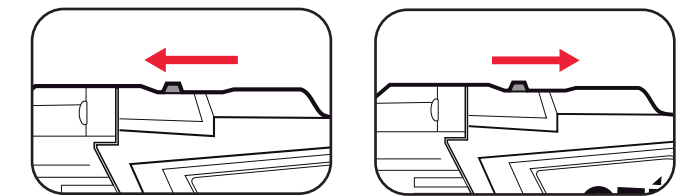

### 5. DRILLING

Before starting to drill, perform a few simple checks.

- 1 Depress and release the variable speed trigger to ensure it is not locked on.
- 2 Check the forward/reverse lever is on desired setting.

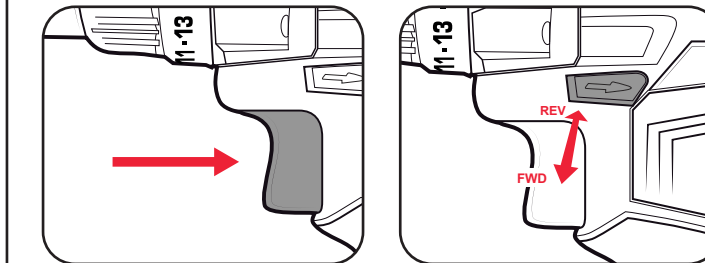

- 3 Secure the material to be drilled in a vice or clamp to stop it turning whilst drilling.

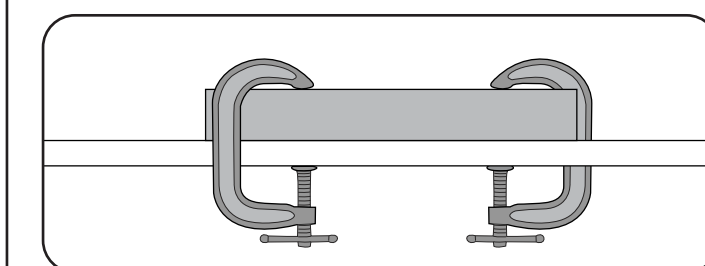

- 4 Hold the drill firmly and place the bit at the point to be drilled.
- 5 Depress the variable speed trigger to start the drill.

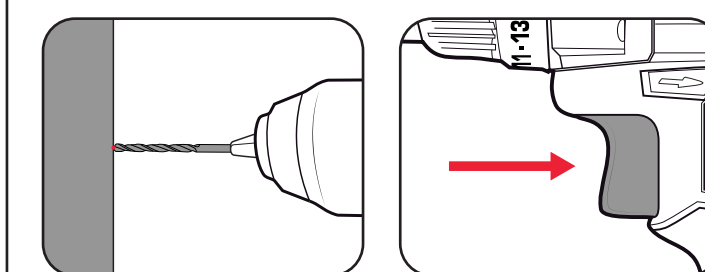

- 6 Move the drill bit into the workpiece.

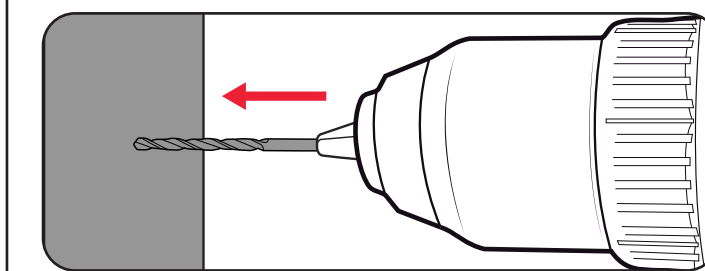

**Note:** Do not force the drill or apply side pressure to elongate the hole. Let the drill do all the work.

### 6. HELPFUL TIPS

#### Drilling to a Preset Depth

A simple way of achieving a hole at a desired depth is to use masking tape.

- 1 Measure along the drill bit to indicate the desired depth.
- 2 Wrap a small piece of masking tape tightly around the drill bit.

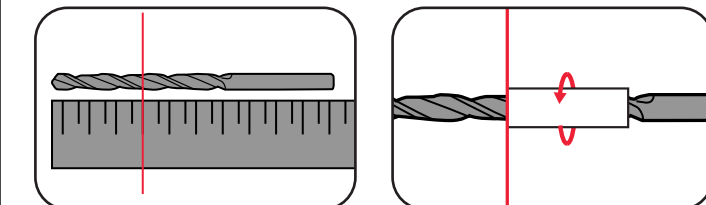

- 3 Drill into the material until the surface reaches the start of the tape.

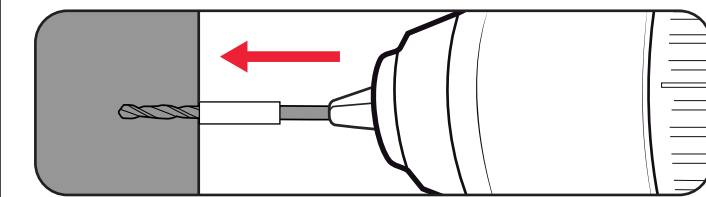

#### Torque Settings

Torque settings can alter the depth to which you can drill or drive into a surface. To determine the torque setting required to drive a screw perfectly flush to the work surface, follow the below steps.

- 1 Set the torque collar to lowest setting and tighten the first screw.

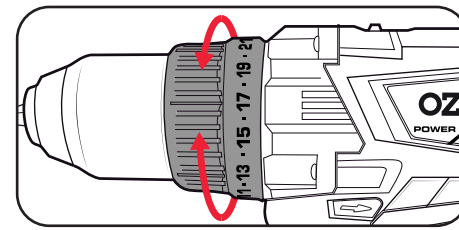

- 2 If the clutch ratchets and makes a clicking sound before screw is flush, increase the collar setting and continue tightening.

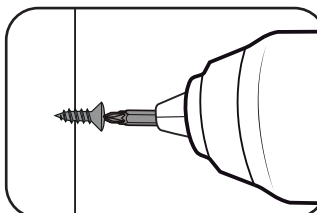

- 3 Repeat until you reach the correct setting/ screw depth. Use this setting for the remaining screws.

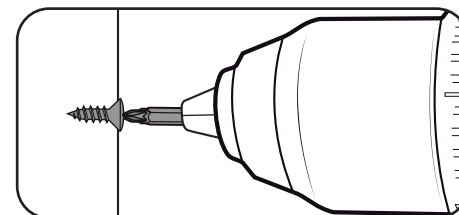

When drilling hard, smooth surfaces, use a centre punch to mark the desired hole location. This measure will prevent the drill bit from slipping off centre as you start the hole.

When drilling metals, use light oil on the drill bit to keep it from overheating. The oil will prolong the life of the bit and increase drilling action.

**5 YEAR**  
REPLACEMENT WARRANTY