



FULL BOAR

DRYWALL SANDER KIT

- **600W MOTOR**
- **PIVOTING SANDING HEAD**
- **HOOK & LOOP SYSTEM**
- **6 SANDING SHEETS & KIT BOX INCLUDED**



INSTRUCTION MANUAL



WARNING: Read all safety warnings and instructions before use. Failure to follow the warnings and instructions may result in electric shock, fire and/or serious injury. Save these instructions for future reference.

SPECIFICATIONS - MODEL NO. FBDWS-6100U

Voltage:	230-240V ~ 50Hz
Power:	600W
Sanding Paper Size:	Ø225mm
Paper Fitment:	Hook & Loop
No Load Speed:	600-1500/min
Weight (Tool Only):	3.2kg

KNOW YOUR PRODUCT

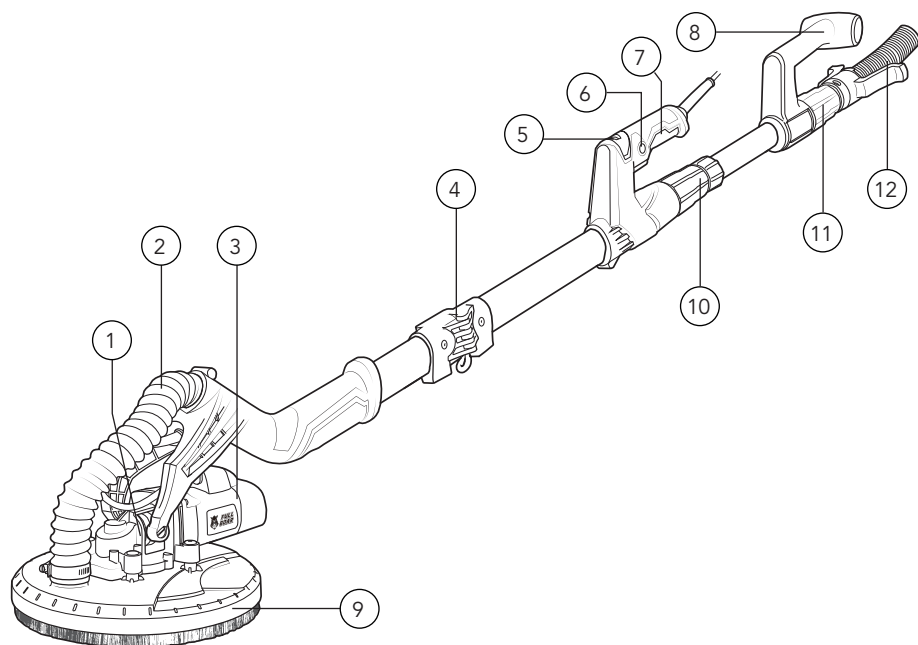

- | | |
|---------------------------|---------------------------|
| 1. Pivoting head | 7. Soft grip main handle |
| 2. Extraction hose | 8. Adjustable rear handle |
| 3. Motor housing | 9. Sanding head |
| 4. Collapsible handle | 10. Extension handle lock |
| 5. Variable speed control | 11. Extraction hose lock |
| 6. Lock-on button | 12. Extraction hose |

TABLE OF CONTENTS

SPECIFICATIONS.....	Page 02
KNOW YOUR PRODUCT.....	Page 02
INTRODUCTION.....	Page 04
SAFETY INSTRUCTIONS.....	Page 04
ASSEMBLY.....	Page 08
CONTROLS.....	Page 10
OPERATION.....	Page 11
MAINTENANCE.....	Page 12
TROUBLE SHOOTING	Page 13
DESCRIPTION OF SYMBOLS.....	Page 14
CONTENTS.....	Page 15
WARRANTY.....	Page 16

INTRODUCTION

Congratulations on purchasing a Full Boar drywall sander kit. It will make quick work of sanding plasterboards to achieve a smooth finish, ready for paint.

Read and understand the instruction manual before operating the demolition hammer. Failure to do so could result in personal injury or equipment damage.

ELECTRICAL SAFETY

 **WARNING!** When using mains-powered tools, basic safety precautions, including the following, should always be followed to reduce risk of fire, electric shock, personal injury and material damage.

Read the whole manual carefully, and make sure you know how to switch the tool off in an emergency, before operating the tool. Save these instructions and other documents supplied with this tool for future reference. The manufacturer cannot accept any liability for damage or accidents which arise due to a failure to follow these instructions and the safety information.

Before you connect the equipment to the mains supply make sure that the data on the rating plate is identical to the mains data.



This tool is double insulated therefore no earth wire is required.

The power supply for this product should be protected by a residual current device (rated at 30mA or less). A residual current device reduces the risk of electric shock.

If the supply cord of this power tool is damaged, it must be replaced by a specially prepared cord available through the service organisation.

Note: Double insulation does not take the place of normal safety precautions when operating this tool. The insulation system is for added protection against injury resulting from a possible electrical insulation failure within the tool.

Using an extension lead

Always use an approved extension lead suitable for the power input of this tool. Before use, inspect the extension lead for signs of damage, wear and ageing. Replace the extension lead if damaged or defective.

When using an extension lead on a reel, always unwind the lead completely. Use of an extension lead not suitable for the power input of the tool or which is damaged or defective may result in a risk of fire and electric shock.

GENERAL SAFETY INSTRUCTIONS



WARNING! Read all safety warnings and all instructions. Failure to follow the warnings and instructions may result in electric shock, fire and/or serious injury.

Save all warnings and instructions for future reference. The term 'power tool' in the warnings refers to your mains-operated (corded) power tool or battery-operated (cordless) power tool.

1. WORK AREA SAFETY

- a. **Keep work area clean and well lit.** Cluttered or dark areas invite accidents.
- b. **Do not operate power tools in explosive atmospheres, such as in the presence of flammable liquids, gases or dust.** Power tools create sparks, which may ignite the dust or fumes.
- c. **Keep children, pets and bystanders away while operating a power tool.** Distractions can cause you to lose control.

2. ELECTRICAL SAFETY

- a. **Power tool plugs must match the outlet. Never modify the plug in any way. Do not use any adapter plugs with earthed (grounded) power tools.** Unmodified plugs and matching outlets will reduce risk of electric shock.
- b. **Avoid body contact with earthed or grounded surfaces, such as pipes, radiators, ranges and refrigerators.** There is an increased risk of electric shock if your body is earthed or grounded.
- c. **Do not expose power tools to rain or wet conditions.** Water entering a power tool will increase the risk of electric shock.
- d. **Do not abuse the cord. Never use the cord for carrying, pulling or unplugging the power tool. Keep cord away from heat, oil, sharp edges or moving parts.** Damaged or entangled cords increase the risk of electric shock.
- e. **When operating a power tool outdoors, use an extension cord suitable for outdoor use.** Use of a cord suitable for outdoor use reduces the risk of electric shock.
- f. **If operating a power tool in a damp location is unavoidable, use a residual current device (RCD) protected supply.** Use of an RCD reduces the risk of electric shock.

3. PERSONAL SAFETY

- a. **Stay alert, watch what you are doing and use common sense when operating a power tool. Do not use a power tool while you are tired or under the influence of drugs, alcohol or medication.** A moment of inattention while operating power tools may result in serious personal injury.
- b. **Use personal protective equipment. Always wear eye protection.** Protective equipment such as dust mask, non-skid safety shoes, hard hat, or hearing protection used for appropriate conditions will reduce personal injuries. Wear ear protectors when impact drilling. Exposure to noise can cause hearing loss.
- c. **Prevent unintentional starting. Ensure the switch is in the off-position before connecting to power source and/or battery pack, picking up or carrying the tool.** Carrying power tools with your finger on the switch, or energising power tools that have the switch on, invites accidents.
- d. **Remove any adjusting key or wrench before turning the power tool on.** A wrench or a key left attached to a rotating part of the power tool may result in personal injury.
- e. **Do not overreach. Keep proper footing and balance at all times.** This enables better control of the power tool in unexpected situations.
- f. **Dress properly. Do not wear loose clothing or jewellery. Keep your hair, clothing and gloves away from moving parts.** Loose clothes, jewellery or long hair can be caught in moving parts.
- g. **If devices are provided for the connection of dust extraction and collection facilities, ensure these are connected and properly used.** Use of dust collection can reduce dust-related hazards.

4. POWER TOOL USE AND CARE

- a. **Do not force the power tool. Use the correct power tool for your application.** The correct power tool will do the job better and safer at the rate for which it was designed.
- b. **Do not use the power tool if the switch does not turn it on and off.** Any power tool that cannot be controlled with the switch is dangerous and must be repaired.

GENERAL POWER TOOL SAFETY WARNINGS

- c. **Disconnect the plug from the power source and/or the battery pack from the power tool before making any adjustments, changing accessories, or storing power tools.** Such preventive safety measures reduce the risk of starting the power tool accidentally.
 - d. **Store idle power tools out of the reach of children and do not allow persons unfamiliar with the power tool or these instructions to operate the power tool.** Power tools are dangerous in the hands of untrained users.
 - e. **Maintain power tools. Check for misalignment or binding of moving parts, breakage of parts and any other condition that may affect the power tool's operation. If damaged, have the power tool repaired before use.** Many accidents are caused by poorly maintained power tools.
 - f. **Keep cutting tools sharp and clean.** Properly maintained cutting tools with sharp cutting edges are less likely to bind and are easier to control.
 - g. **Use the power tool, accessories and tool bits, etc. in accordance with these instructions, taking into account the working conditions and the work to be performed.** Use of the power tool for operations different from those intended could result in a hazardous situation.
- 5. SERVICE**
- a. **Have your power tool serviced by a qualified repair person using only identical replacement parts.** This will ensure that the safety of the power tool is maintained.

DRYWALL SANDER SAFETY WARNINGS

 **WARNING!** This appliance is not intended for use by persons (including children) with reduced physical, sensory or mental capabilities, or lack of experience and knowledge, unless they have been given supervision or instruction concerning use of the appliance by a person responsible for their safety.

Safety warnings common for sanding operations:

- a) **This power tool is intended to function as a sander. Read all safety warnings, instructions, illustrations and specifications provided with this power tool.** Failure to follow all instructions listed below may result in electric shock, fire and/or serious injury.
- b) **Operations such as grinding, wire brushing or cutting-off are not recommended to be performed with this power tool.** Operations for which the power tool was not designed may create a hazard and cause personal injury.
- c) **Do not use accessories which are not specifically designed and recommended by the tool manufacturer.** Just because the accessory can be attached to your power tool, it does not assure safe operation.
- d) **The rated speed of the accessory must be at least equal to the maximum speed marked on the power tool.** Accessories running faster than their rated speed can break and fly apart.
- e) **The outside diameter and the thickness of your accessory must be within the capacity rating of your power tool.** Incorrectly sized accessories cannot be adequately guarded or controlled.
- f) **Threaded mounting of accessories must match the spindle thread.** Accessories that do not match the mounting hardware of the power tool will run out of balance, vibrate excessively and may cause loss of control.
- g) **Do not use a damaged accessory. Before each use inspect the accessory such as a backing pad for cracks, tears or excess wear. If the power tool or accessory is dropped, inspect for damage or install an undamaged accessory. After inspecting and installing an accessory, position yourself and bystanders away from the plane of the rotating accessory and run the power tool at maximum no-load speed for one minute.** Damaged accessories will normally break apart during this test time.
- h) **Wear personal protective equipment. Depending on application, use a face shield, safety goggles or safety glasses. As appropriate, wear a dust mask, hearing protectors, gloves and workshop apron capable of stopping small abrasive or workpiece fragments.** The eye protection must be capable of stopping flying debris generated by various operations. The dust mask or respirator must be capable of filtering particles generated by your operation. Prolonged exposure to high intensity noise may cause hearing loss.
- i) **Keep bystanders a safe distance away from the work area. Anyone entering the work area must wear personal protective equipment (PPE).** Fragments of workpiece or of a broken accessory may fly away and cause injury beyond immediate area of operation.
- k) **Position the cord clear of the spinning accessory.** If you lose control, the cord may be cut or snagged, and your hand or arm may be pulled into the spinning accessory.
- l) **Never lay the power tool down until the accessory has come to a complete stop.** The spinning accessory may grab the surface and pull the power tool out of your control.
- m) **Do not run the power tool while carrying it at your side.** Accidental contact with the spinning accessory could snag your clothing, pulling the accessory into your body.
- n) **Regularly clean the power tool's air vents.** The motor's fan will draw the dust inside the housing and excessive accumulation of powdered metal may cause electrical hazards.
- o) **Do not operate the power tool near flammable materials.** Sparks could ignite these materials.
- p) **Do not use accessories that require liquid coolants.** Using water or other liquid coolants may result in electrocution or shock.

DRYWALL SANDER SAFETY WARNINGS

Kickback and related warnings

Kickback is a sudden reaction to a pinched or snagged rotating wheel, backing pad, brush or any other accessory. Pinching or snagging causes rapid stalling of the rotating accessory, which, in turn, causes the uncontrolled power tool to be forced in the direction opposite of the accessory's rotation at the point of the binding.

For example, if an abrasive wheel is snagged or pinched by the workpiece, the edge of the wheel that is entering into the pinch point can dig into the surface of the material, causing the wheel to climb out or kick out. The wheel may either jump toward or away from the operator, depending on direction of the wheel's movement at the point of pinching. Abrasive wheels may also break under these conditions.

Kickback is the result of power tool misuse and/or incorrect operating procedures or conditions and can be avoided by taking proper precautions as given below.

- a) **Maintain a firm grip on the power tool and position your body and arm to allow you to resist kickback forces. Always use the auxiliary handle, if provided, for maximum control over kickback or torque reaction during start-up.** The operator can control torque reactions or kick back forces if proper precautions are taken.
- b) **Never place your hand near the rotating accessory.** Accessory may kickback over your hand.
- c) **Do not position your body in the area where the power tool will move if kickback occurs.** Kickback will propel the tool in the direction opposite to the wheel's movement at the point of snagging.
- d) **Use special care when working corners, sharp edges, etc. Avoid bouncing and snagging the accessory.** Corners, sharp edges or bouncing have a tendency to snag the rotating accessory and cause loss of control or kickback.
- e) **Do not attach a saw chain woodcarving blade or toothed saw blade.** Such blades create frequent kickback and loss of control.

Safety warnings specific for sanding operations

- a) **Do not use excessively oversized sanding disc paper. Follow manufacturer's recommendations when selecting sanding paper.** Larger sanding paper extending beyond the sanding pad presents a laceration hazard and may cause snagging, tearing of the disc or kickback.

Unplug the sander before changing accessories. Accidental start-ups may occur if the sander is plugged in while changing an accessory.

Disposing of dust. Be extremely careful of dust disposal, materials in fine particle form may be explosive. Do not throw sanding dust on an open fire. Spontaneous combustion may, in time, result from a mixture of oil or water with dust particles.

 **WARNING!** Some dust created by power sanding, sawing, grinding, drilling and other construction activities, contain chemicals known to cause cancer, birth defects or other reproductive harm.

Some examples of these chemicals are:

- Lead from lead-based paints;
- Crystalline silica from bricks, cement and other masonry products, and;
- Arsenic and chromium from chemically-treated timber.

The risk from such exposures vary depending on how often you do this type of work. To reduce your exposure to these chemicals, work in a well-ventilated area, and work with approved safety equipment, such as those dust masks that are specifically designed to filter out microscopic particles.

ASSEMBLY

WARNING! Ensure the tool is turned off and disconnected from the power supply before performing any of the following operations.

Assembling the handle

The Full Boar Drywall Sander features a collapsible handle to enable compact storage inside the kitbox. To operate the sander, this handle will have to be locked into the operating position.

1. Unfold the collapsible handle so that the shaft is in a continuous straight line (Fig. 1).
2. Secure in place using the collapsible handle lock (Fig. 2).
3. To collapse the handle again for storage, unlock the collapsible handle lock.
4. Then fold the handle and place back inside the kitbox.

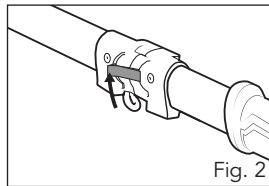
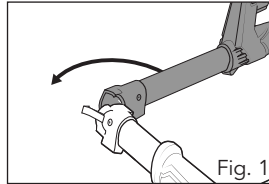

Fitting the rear extension handle

The rear extension handle can provide additional support when sanding surfaces high above your head or far away from your body.

1. Loosen the extension handle lock by rotating it anti-clockwise (Fig. 3).
2. Insert the extension handle into the extension handle lock (Fig. 4).
3. Rotate the extension handle clockwise to secure the rear extension handle.

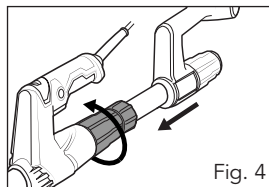
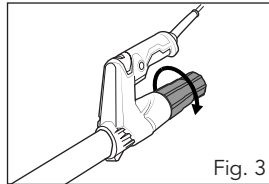

Adjusting the rear extension handle

The rear extension handle can be adjusted or rotated to suit a range of desired positions.

1. Rotate the rear extension handle lock by rotating it anti-clockwise.
2. Adjust the length of the extension handle or rotate into the desired position (Fig. 5).

Note: Ensure that you do not extend the extension handle beyond the 'Max' mark indicated on the shaft.

3. Secure in place by rotating the extension handle lock clockwise.

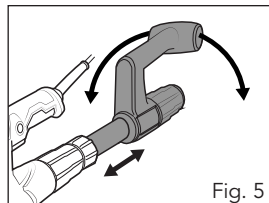

ASSEMBLY

CAUTION! For health and safety reasons, this drywall sander should be used with a dust extraction unit or vacuum at all times.

Connecting the dust extraction hose

The Full Boar Drywall Sander comes complete with a dust extraction hose that can be fitted to the tool and used with a dust extraction unit or vacuum to minimise the amount of dust in the air and on the working surface. Please note that the vacuum or dust extraction unit should have a self-cleaning filtration system to prevent clogging the filter and potentially overheating the unit.

1. Loosen the extraction hose lock by rotating it anti-clockwise.
2. Insert the extraction hose into the hose lock (Fig. 6).
3. Rotate the extraction hose lock clockwise to secure the extraction hose (Fig. 6).
4. Connect the other end of the dust extraction hose to your dust extraction unit or vacuum.

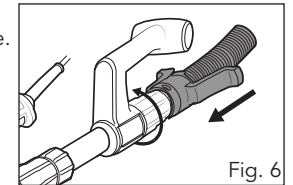

Fitting/removing sanding paper

The sanding head features a 'hook & loop' paper fitment to allow quick and easy sand paper changes. Only use the drywall sander with 225mm diameter sanding paper.

1. Place the sanding sheet onto the sanding pad, ensuring the extraction holes align with the holes in the sand paper (Fig. 7).
2. Push the entire sanding sheet firmly onto the sanding pad to ensure it is secured correctly.
3. To remove the sanding sheet, peel off the sheeting starting at the edge.

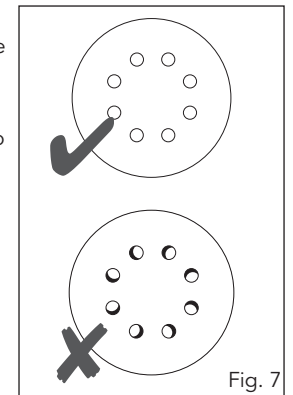

CONTROLS

Variable speed control

1. To increase the speed of the sander, rotate the variable speed control to the right.
2. To decrease the speed of the sander, rotate the variable speed control to the left.

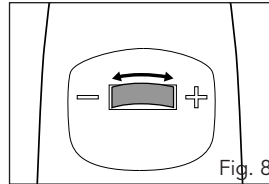

On/off trigger

1. To start the tool, squeeze the on/off trigger.
2. To stop the drywall sander, release the on/off trigger.

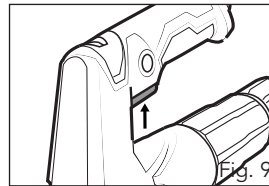

Lock-on button

The drywall sander features a lock-on button to allow you to continue operation without having to hold down the on/off trigger.

1. Press and hold the on/off trigger to start the tool.
2. Press the lock-on button and then release the trigger.
3. To stop the sander, press and release the on/off trigger.

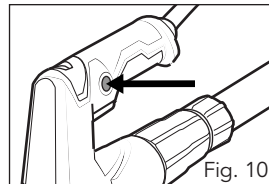

Pivoting sanding head

The drywall sander sanding head has a 2 axis pivoting feature, which allows greater user comfort in any sanding position.

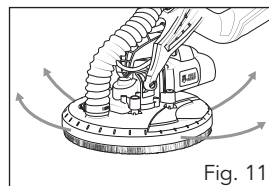

OPERATION

WARNING! To reduce the risk of electric shock, a residual current device rated at 30mA or less must be used.

1. Select the desired speed using the variable speed control and then hold the drywall sander securely.
2. Place the sanding surface area flat onto the working surface and start the sander by squeezing the on/off trigger.
3. Move the sander smoothly with gentle pressure in circular or transverse movements.
4. Once the job is complete, stop the sander and wait for the disc to completely stop before sitting the tool down.

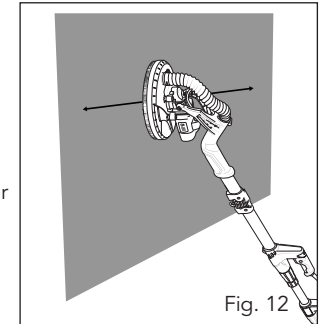

Sand paper selection

Selecting the correct grit of sandpaper is an important step in achieving optimum results. Coarse grit will remove the most material. Finer grit will produce a smoother finish. The higher the grit number, the finer the grade of sandpaper.

If the surface is rough, start with a coarse grit and sand until the surface is uniform. Medium grit may then be used to remove scratches left by the coarser grit. Finer grit is then used to finish the surface. Always continue sanding with each grade of sandpaper until the surface is uniform.

Note: If intermediate sanding is required, choose a grit rating between coarse and fine. To ensure a satisfactory result, a small, inconspicuous area should first be tested to ensure the grit of sandpaper chosen is suitable for the desired finish.

Sanding tips

Never force the sander. Applying excessive pressure will slow the motor, rapidly wear the sandpaper, and greatly reduce the sander speed. This will slow the removal rate and produce an inferior quality surface.

CAUTION: Excessive pressure will overload the motor, causing possible damage to the sander by overheating the motor, or damage to the working surface.

Be sure to check your working surface often. The sander is capable of removing material rapidly, especially with coarse paper. Do not sand on one spot for too long. The sander's rapid action may remove too much material, creating an uneven surface.

MAINTENANCE

- Keep the ventilation vents of the drywall sander clean at all times.
- After each use, blow air through the drywall sander housing to ensure it is free from all dust particles that may build up. Build up of dust particles may cause the sander to overheat and fail.
- If the enclosure of the drywall sander requires cleaning, do not use solvents but a moist, soft cloth only. Never let any liquid get inside the tool; never immerse any part of the sander into a liquid.

Carbon brushes

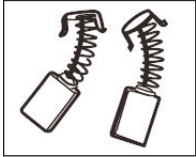

When the carbon brushes wear out, the drywall sander will spark and/or stop. Discontinue use as soon as this happens. They should be replaced prior to recommencing use of the sander. Carbon brushes are a wearing component of the drywall sander and, therefore, not covered under warranty. Continuing to use the tool when carbon brushes need to be replaced may cause permanent damage to the sander. Carbon brushes will wear out after many





uses but when the carbon brushes need to be replaced, take the drywall sander to an electrician or a power tool repairer for a quick and low cost replacement. Always replace both carbon brushes at the same time.

Note: Ozito Industries will not be responsible for any damage or injuries caused by the repair of the drywall sander by an unauthorised person or by mishandling of the sander.

TROUBLESHOOTING

Problem	Cause	Remedy
Drywall sander is not working	No power supplied.	Make sure the power plug is connected and power outlet is in working order.
Sparking visible through the housing air vents	A small amount of sparking may be visible through the housing vents. This is normal and does not indicate a problem.	This is normal and does not indicate a problem.
Excessive sparking visible through air vents	May indicate the carbon brushes have worn out and need to be replaced.	Get a qualified electrician or power tool repairer to replace carbon brushes.

DESCRIPTION OF SYMBOLS

V	Volts	Hz	Hertz
~	Alternating current	W	Watts
/min	Revolutions or reciprocation per minute	n_0	No load speed
mm	Millimetres	∅	Diameter
	Double insulated		Read instruction manual
	Warning		Wear eye protection
	Wear ear protection		

CONTENTS

- | | |
|--------------------------|--------------------|
| 1 x Drywall sander | 6 x Sanding sheets |
| 1 x Extension handle | 1 x Carry case |
| 1 x Dust extraction hose | |

Note: The manufacturer's liability shall be deemed void if the machine is modified in any way, and the manufacturer shall, therefore, accept no liability for any damages arising as a result of modifications.

WARRANTY

All of our products undergo strict quality checks to ensure that they reach you in perfect condition. In the unlikely event that your device develops a fault, please contact our service department at the address shown on this guarantee card. You can also contact us by telephone using the customer service number shown. Please note the following terms under which guarantee claims can be made:

1. These warranty terms regulate additional warranty services, which the manufacturer (mentioned below) promises to buyers of its new products. In addition to their statutory guarantee, claims are not affected by this guarantee. Our guarantee is free of charge to you.
2. The warranty services only covers defects due to material or manufacturing faults on this product which you have bought from the manufacturer (mentioned below) and are limited to either the rectification of said defects on the product or the replacement of the product, whichever we prefer.
3. The following are not covered by our guarantee:
 - Damage to the device caused by a failure to follow the assembly instructions or due to incorrect installation; a failure to follow the operating instructions (for example, connecting it to an incorrect mains voltage or current type) or a failure to follow the maintenance and safety instructions; or by exposing the device to abnormal environmental conditions, or by lack of care and maintenance.
 - Damage to the device caused by abuse or incorrect use (for example, overloading the device, or the use of unapproved tools or accessories), ingress of foreign bodies into the device (such as sand, stones or dust, transport damage), the use of force or damage caused by external forces (for example, by dropping it).
 - Damage to the device or parts of the device caused by normal or natural wear or tear, or by normal use of the device.
4. Your product is guaranteed for a period of 12 months from the original date of purchase. Warranty excludes consumable parts. Guarantee claims should be submitted before the end of the guarantee period and within two weeks of the defect being noticed. No guarantee claims will be accepted after the end of the guarantee period. The original guarantee period remains applicable to the device even if repairs are carried out or parts are replaced. In such cases, the work performed or parts fitted will not result in an extension of the guarantee period, and no new guarantee will become active for the work performed or parts fitted. This also applies if an on-site service is used.

Your statutory rights remain unaffected, in particular, any rights you have under the Consumer Rights Act 2015.

IN ORDER TO MAKE A CLAIM UNDER THIS WARRANTY, YOU MUST RETURN THE PRODUCT TO THE PLACE OF PURCHASE WITH YOUR RECEIPT.

Please refer to the restrictions of this warranty concerning wearing parts, consumables and missing parts, as set out in the service information in these operating instructions.

CUSTOMER SERVICE HELPLINE

GB: 0151 294 4488

IRL: 1850 882711

OZITO UK

Unit 9 Stadium Court, Wirral International Business Park, Plantation Road,
Bromborough, Wirral, CH62 3QG