

**GB** **Operating Instructions for the  
Indoor and Outdoor Device**

**Einhell**<sup>®</sup>  
**NEW GENERATION**

**Split-system Air Conditioner**



**Important note:**

**This high-quality product will only offer optimum service if installed correctly and in the right place, and is put into operation for the first time by a suitably competent person. Avoid malfunctions by seeking competent advice from an expert with regards to the location, installation and starting up of the system.**

**We shall accept no liability for malfunctions or inadequate cooling performance resulting from the improper handling of the product.**

**Only a suitably qualified firm is permitted to undertake any work of making the electrical and cooling system connections and putting the system into operation for the first time.**

**If the system is to be moved to another location or disposed of, only a suitably qualified electrician's/cooling system firm is permitted to undertake any work of disassembly or disposal.**



**Art.-Nr.: 23.658.10**

**I.-Nr.: 01015**

**NSK 3500 C+H**

## 1. Safety instructions

- Read the safety instructions before you start to use the device.
- These points set out extremely important precautionary measures that you must comply with.
- Keep the Operating Instructions in a safe place once you have read them.
- Check that the drainage line is correctly connected. If not, water will escape.
- **Warning!**  
Do not extend the cable and never use multiple plugs. A poor electrical connection, poor insulation or voltage which is higher than permitted can cause fire.
- **Remove all dirt from the power plug and plug it in firmly. Soiled plugs can cause fire or an electric shock.**
- **Warning!**
- Never pull out the plug while the device is in use.
- Never permit cool air to be blown directly at you for any lengthy period of time.
- In the event of any abnormalities (e.g. smell of burning), immediately switch off the device and pull the plug. Contact your service partner.
- Never poke fingers or sticks in the air inlet and outlet vents.
- Never attempt to repair the air conditioner yourself. Always contact your service partner if it requires repair.
- Never pull the plug out by pulling on the cable. Hold the plug firmly and pull it out of the plug socket, otherwise there is a risk of damaging the cable.
- Always switch off the device and pull the plug before you start to clean it.
- Never actuate any switches with wet hands.
- Never clean the air conditioner with water.
- Never place any plants or animals under a location to which cool air flows as this could have an undesirable affect on them.
- Never use combustible cleaning agents as these could cause a fire or deformation.
- If the air conditioner is to be used in conjunction with other heaters, the air should be refreshed periodically, otherwise there is a risk of lack of oxygen.
- Never use the device for any other purpose than the intended use. Never place food, precision instruments, plants, animals, paint, etc. on the device.
- Never hold any burning objects close to the device if they could be directly affected by the emitted air.

- Always pull out the power plug if the device is not going to be used for any lengthy period of time. Collections of dust can cause fire.
- Never step onto the outdoor device and never place anything on it.
- Never use an unsteady or rusty base.
- Never allow the device to run for too long with the doors or windows open, or if the humidity is very high. If the air conditioner runs for a long time in cooling mode and the humidity is high (over 80%), condensed water may drip out of the device.
- Never stand on an unsteady base when you remove the device from the holder on the wall.
- Check that the condensation water can run off unhindered. Water damage can result if the condensation water cannot run off properly.
- Never touch any metal parts on the indoor device when removing the air filter. You may injure yourself.
- Never install the device in a room in which combustible gases can be emitted. Emitted gases may collect and cause an explosion.
- Always switch off the device and pull out the power plug during a storm. Electrical parts may get damaged.
- Earthing connection!  
The power cable (plug) comes with an earthing wire. Do not, therefore, change the plug.
- For electrical safety purposes we recommend that you install an earth-leakage circuit-breaker.
- Have all electrical installation work performed by a qualified electrician.
- Ask a service partner or specialist cooling system firm to undertake all work of cooling system-related installation.
- Incorrect installation may cause injury or damage to the device.

## 2. Items supplied

- 1 indoor device (box 1, art. no. 23.653.94)
- 1 outdoor device (box 2, art. no. 23.653.95)
- 1 set of installation accessories (for details, see page 14)

### 3. Technical data

Cooling capacity	3,500 watts
Heating capacity	3,700 watts
Energy efficiency	A (EER 3.27/COP 3.46)
Air capacity	500 m <sup>3</sup> /h
Absorbed humidity	1.0 l/h
Timer	24 h
Operating voltage	220 - 240/50 V ~ Hz
Nominal power consumption, cooling	1,440 watts
Nominal current consumption, cooling	6.26 A
Nominal power consumption, heating	1,440 watts
Nominal current consumption, heating	6.26 A
Compressor	Rotary piston
Starting current	30 A
Outdoor temperature, cooling operation °C	+21 - +43 (DB)
Outdoor temperature, heating operation °C	0 - + 24 (DB)
Fluid line Ø A	6 mm
Suction pipe Ø A	12 mm
Length of refrigerant line supplied	4 m
Length of refrigerant line, max.	10 m
Max. difference in height between indoor/outdoor device	5 m
Refrigerant	R 410 A
Refrigerant filling capacity	1,400 g
Refrigerant refill quantity from 5 m	20 g/m
Sound pressure level	
Inside	≤ 40 dB (A)
Outside	≤ 54 dB (A)
Dimensions	
Inside	100,5 x 29 x 15 cm
Outside	84,8 x 54 x 32 cm
Weight	
Inside	11 kg
Outside	36 kg

#### Note:

The specified capacities and performances are based on the following conditions (ISO 5151):

#### Cooling:

Air temperature at the inlet on the indoor device: 27°C for dry thermometer bulb (DB), 19°C for wet thermometer bulb (WB). Outdoor air temperature: 35°C for dry thermometer bulb (DB), 24°C for wet thermometer bulb (WB).

#### Heating:

Air temperature at the inlet on the indoor device: 20°C for dry thermometer bulb (DB), 15°C for wet thermometer bulb (WB). Outdoor air temperature: 7°C for dry thermometer bulb (DB), 6°C for wet thermometer bulb (WB).

#### 4. Description of parts

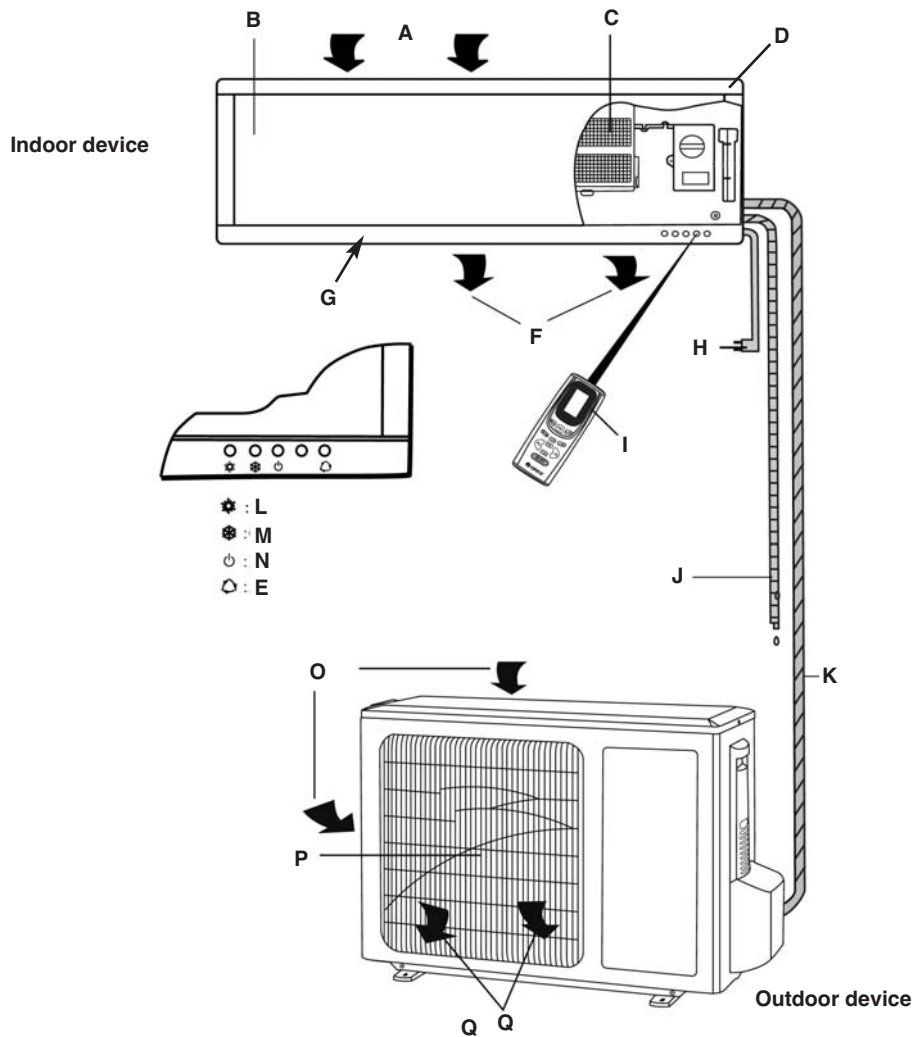

#### Legend for parts description figure:

- |   |                          |
|---|--------------------------|
| A: Air inlet                                | L: Heating               |
| B: Cover                                    | M: Cooling/dehumidifying |
| C: Air filter                               | N: Operating display     |
| D: Housing                                  | O: Air inlet             |
| E: Emergency switch for automatic operation | P: Air outlet grille     |
| F: Air outlet                               | Q: Air outlet            |
| G: Slat                                     |                          |
| H: Power cable                              |                          |
| I: Infrared remote control                  |                          |
| J: Condensation water hose                  |                          |
| K: Refrigerant line                         |                          |

## 5. Setting up the remote control

### Insert batteries

1. Open the battery compartment cover.
  2. Insert two new batteries. Be sure to observe the correct polarity (+/-) of the batteries.
  3. Close the battery compartment cover.
- The radio signal has a range of approx. 8 m.
  - When the ON/OFF button is pressed, the indoor device will emit an audio signal once or twice to indicate that the device has received the signal.
  - Handle the remote control with care and, in order to avoid malfunctions, never drop it or leave it in a damp location.
  - If the signal on the remote control becomes weak or the indicator on the remote control becomes difficult to read, replace the batteries **immediately**.
  - It is important that the + and – terminals on the batteries are correctly positioned in the remote control.
  - Both batteries should always be new and of the same make.

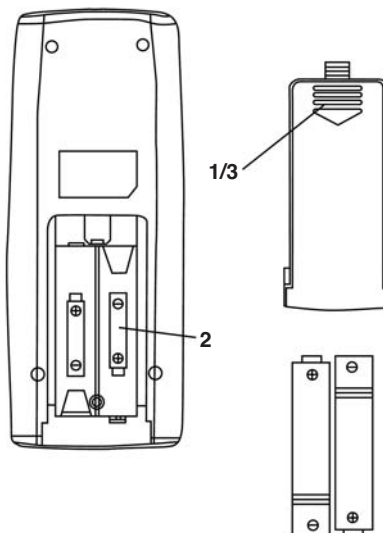

## 6. Functional description of the remote control

### Key assignment

- 1 "Mode" (operating mode) key
  - 2 "Fan" (fan speed) key
  - 3 "Sleep" (sleep function) key
  - 4 "Swing" (automatic, horizontal slat adjustment) key
  - 5 "+ °C" (temperature increase) key
  - 6 "- °C" (temperature decrease) key
  - 7 "T-ON" (device ON timer) key
  - 8 "T-OFF" (device OFF timer) key
  - 9 "ON-OFF" (device ON/OFF) key
- "AIR" and "LIGHT" keys are not assigned

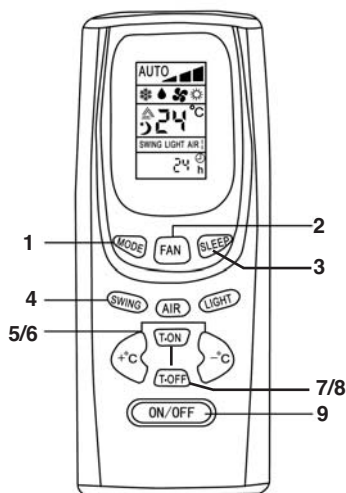

**Display**

- 1 "Fan speed" display
- 2 "Mode" display
- 3 "Temperature" display
- 4 "Sleep mode" display
- 5 "Slat adjustment" display
- 6 "Timer" display

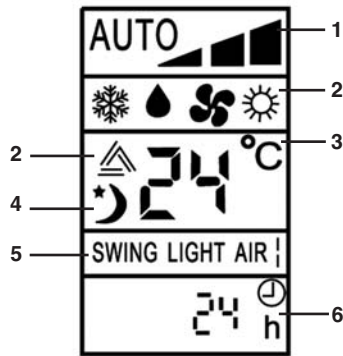

**Remote control brief description**

**1 "Mode" (operating mode) key**

This key is used to select one of the available operating modes. The operating mode changes in the following sequence per key press:

**Automatic -> Cooling -> Dehumidifying -> Fan -> Heating**

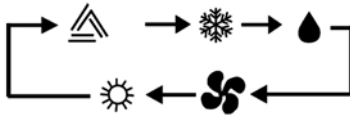

**2 "Swing" (automatic, horizontal slat adjustment) key**

Press this key once for electric, horizontal slat adjustment. The air flow is adjusted upwards/downwards. Press the key twice to lock the slats in their current position.

**3 "+ °C" (temperature increase) and "- °C" (temperature decrease) keys**

Press the "+ °C" key once to increase the set temperature by 1 °C. Press the "- °C" key once to decrease the set temperature by 1 °C.

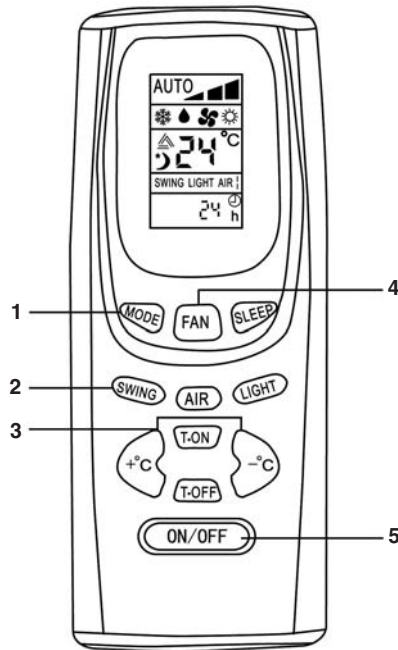

The temperature can be set from 16 °C to 30 °C on the remote control via the "Cooling", "Dehumidifying" and "Heating" operating modes.

The temperature cannot be set in the "Automatic" and "Fan" modes.

**4 "Fan" (fan speed) key**

The fan speed changes in the following sequence per key press:

**Automatic -> Slow -> Medium -> Fast**



**5 "ON-OFF" (device ON/OFF) key**

This key is pressed to switch the device on and off.

### 6 LCD display

All settings are displayed.

### 7 "Sleep" (sleep function) key

Press this key once to activate the sleep function.  
Press the key twice to switch the function back off.

### 8 "T-ON" (device ON timer) key

Press this key to automatically switch on the device within a 0.5 and 24 hour range.

### 9 "T-OFF" (device OFF timer) key

Press this key to automatically switch off the device within a 0.5 and 24 hour range.

### Note:

The "AIR" and "LIGHT" keys are not assigned and do not influence the device when pressed.

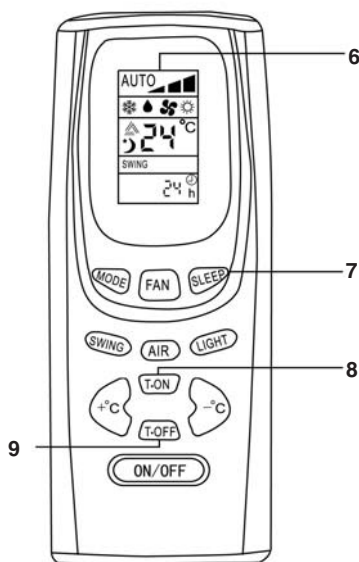

## Operating modes

### A) Cooling mode

1. Press the "ON/OFF" key to switch on the device.
2. Press the "MODE" key until the "Cooling" mode icon appears in the display.
3. Press the "Swing" key. The air flow is adjusted upwards/downwards. Press the key twice to lock the slats in their current position.
4. Press the "FAN" key to select the fan speed: Automatic -> Slow -> Medium -> Fast
5. Press the "+ °C" or "- °C" key to set the desired temperature.

### Notes!

- The cooling mode will only work if the room temperature set is lower than the current room temperature. When the set room temperature is reached, the outdoor compressor stops. The centrifugal fan of the indoor device circulates the air in the room.
- The set room temperature should not be more than 5 °C below the outdoor temperature (example: outdoor temperature 30 °C, ideal room temperature 25 °C).
- The room temperature can be set between 16 °C and 30 °C with the remote control.
- The higher the outdoor temperature, the higher the attainable indoor temperature

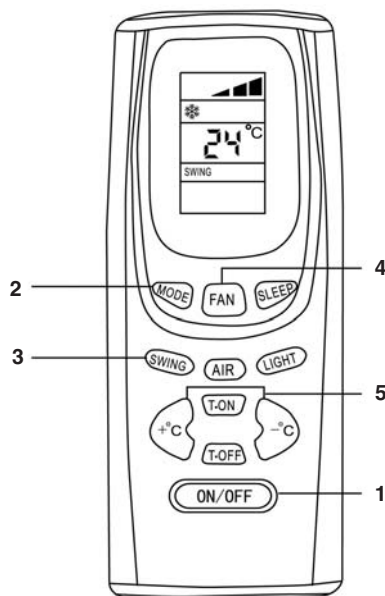

**B) Heating mode**

1. Press the "ON/OFF" key to switch on the device.
2. Press the "MODE" key until the "Heating" mode icon appears in the display.
3. Press the "Swing" key. The air flow is adjusted upwards/downwards. Press the key twice to lock the slats in their current position.
4. Press the "FAN" key to select the fan speed: Automatic -> Slow -> Medium -> Fast
5. Press the "+ °C" or "- °C" key to set the desired temperature.

**Notes!**

- The heating mode will only work if the room temperature set is higher than the current room temperature. When the set room temperature is reached, the outdoor compressor stops. The centrifugal fan of the indoor device circulates the air in the room.
- The room temperature can be set between 16 °C and 30 °C with the remote control.
- The attainable room temperature is a factor of local conditions and the outdoor temperature. The cooler the outdoor temperature, the lower the attainable room temperature.

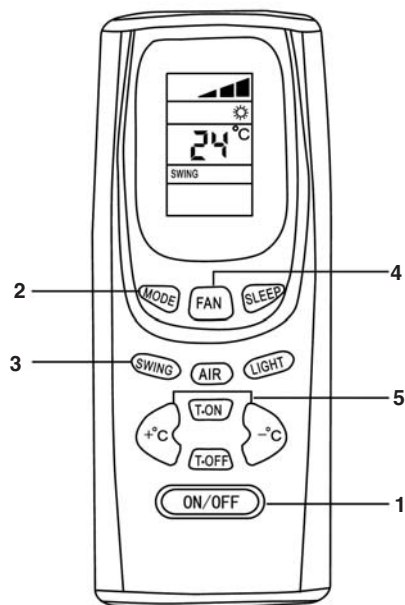
**C) Dehumidifying mode**

1. Press the "ON/OFF" key to switch on the device.
2. Press the "MODE" key until the "Dehumidifying" mode icon appears in the display.
3. Press the "Swing" key. The air flow is adjusted upwards/downwards. Press the key twice to lock the slats in their current position.
4. Press the "+ °C" or "- °C" key to set the desired temperature.

**Notes!**

- The "Dehumidifying" mode only works if the difference between the set room temperature and the current room temperature is within +/- 2 °C.
- If the room temperature set for the "Dehumidifying" mode is more than 2 °C higher than the current room temperature, the compressor stops along with the fan in the outdoor device. The centrifugal fan of the indoor device is also switched off.
- If the room temperature set for the "Dehumidifying" mode is more than 2 °C below the current room temperature, the device runs in cooling mode.
- The room temperature can be set between 16 °C and 30 °C with the remote control.

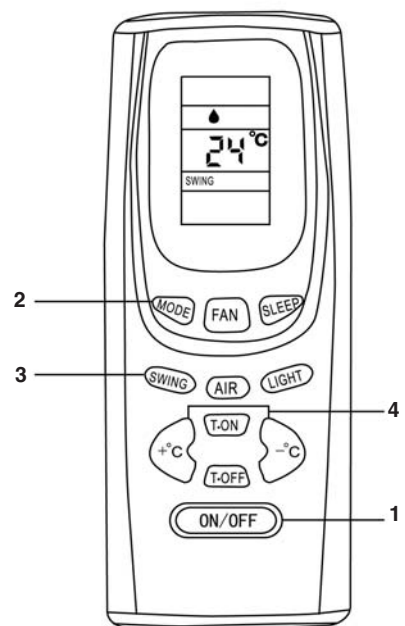



**D) Automatic mode**

1. Press the "ON/OFF" key to switch on the device.
2. Press the "MODE" key until the "Automatic" mode icon appears in the display. The device automatically switches to cooling, fan or heating mode, depending on the current room temperature.
3. Press the "FAN" key to select the fan speed: Automatic -> Slow -> Medium -> Fast

**Notes!**

- When "Automatic" mode is selected, the room temperature is fixed at 25 °C for cooling and 20 °C for heating. These temperatures cannot be changed.
- When the current room temperature is between 23 °C and 26 °C in "Automatic" mode, the device runs as a fan without the effect of heating or cooling.
- When the current room temperature is greater than 26 °C in "Automatic" mode, the device runs with a cooling effect.
- When the current room temperature is below 22 °C in "Automatic" mode, the device runs with a heating effect.

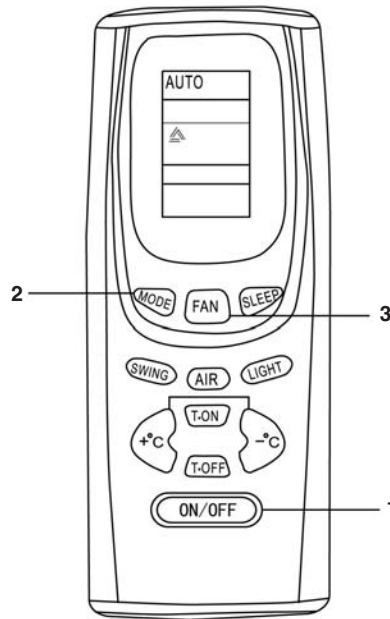

**E) Sleep function**

1. Press the "ON/OFF" key to switch on the device.
2. Press the "MODE" key until the "Cooling", "Dehumidifying" or "Heating" mode icon appears in the display.
3. Press the "Swing" key. The air flow is adjusted upwards/downwards. Press the key twice to lock the slats in their current position.
4. Press the "FAN" key to select the fan speed: Automatic -> Slow -> Medium -> Fast
5. Press the "+ °C" or "- °C" key to set the desired temperature.
6. Press the "Sleep" key to activate the sleep function.

**Notes!**

- If the cooling or dehumidifying mode is set in conjunction with the sleep function, the set room temperature increases (1 °C during the first hour and 2 °C during the second hour) in order to prevent overcooling.
- If the heating mode is set in conjunction with the sleep function, the set room temperature decreases (1 °C during the first hour and 2 °C during the second hour) in order to prevent overheating.

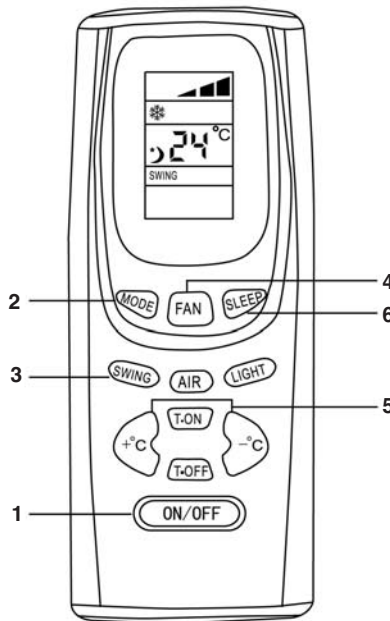

## F) Timer settings (for automatically switching the device on/off)

### 1. "T-ON" (device ON timer) key

This key is pressed to automatically switch on the unit. The only requirement is that the unit be connected to a power supply. Each time the key is pressed, the time setting changes by an increment of 0.5 hours within a 0.5 and 24 hour range. To switch the "Device ON timer" back off, press the key again after "24h" is displayed or switch off the device by pressing the "ON/OFF" key.

### 2. "T-OFF" (device OFF timer) key

This key is pressed to automatically switch off the unit. The only requirement is that the unit be in operation. Each time the key is pressed, the time setting changes by an increment of 0.5 hours within a 0.5 and 24 hour range. To switch the "Device OFF timer" back off, press the key again after "24h" is displayed or switch off the device by pressing the "ON/OFF" key.

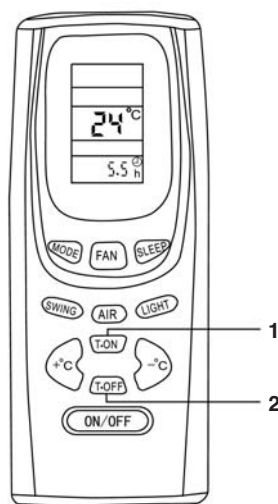

## 7. Indoor device settings

The left-hand and right-hand side flow directions can be adjusted manually.

Perform these adjustments before you start the device because once it has been started the slats vibrate and there is a risk of your fingers getting caught.

### Remote control fails to work (emergency operation)

If the remote control fails to work (empty batteries or malfunction), use the emergency switch (A).

- The device is off: After the emergency stop switch has been pressed the device switches to automatic mode. The slat adjuster also operates in automatic mode.
- The device is on: The device switches off if the emergency switch is pressed.

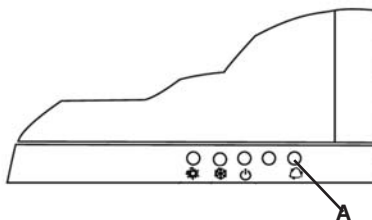

## 8. Cleaning notes

### Important!

Switch the device off and pull the mains plug each time before cleaning.

### Note!

The time intervals at which the device should be cleaned are a factor of the area of installation. The time intervals listed below should be maintained in most cases.

Keep the outdoor device and the area around the outdoor device clean. Regularly remove leaves, etc. which can collect around the outdoor device.

### Cleaning the housing of the indoor device

- Clean the housing of the indoor device using only a soft, wet cloth when necessary.
- In order to avoid damaging the housing and electronics, avoid the use of gasoline, thinners, scouring powder, cleaners and the like when cleaning.

### Cleaning the air filters of the indoor device

Make sure that the air filters are clean! Soiled air filters reduce the air output of the device. The air filters of the indoor device should be checked and, if necessary, cleaned on a monthly basis.

1. Pull on the recess at the right and left by the panel and open. The opening angle is limited by the lateral guides.
2. Carefully pull the panel up out of the brackets and fold the brackets back down.
3. Now lift the panel a little and remove the air filters below.
4. Carefully vacuum off the air filters or wash them using a neutral soap solution. Note that the water temperature must not exceed 45 °C, as the air filters would then change in color and could become distorted. Let the air filters dry in the shade.
5. To reinstall the air filters in the indoor device, lift the panel a little and reinsert.
6. Lower the panel back down until it latches into the panel brackets on the inner housing. Close the panel. Replace the air filters once annually. Replacement air filters can be obtained from your service partner.

### Cleaning the heat exchanger of the indoor device

The heat exchanger must be cleaned at least once annually. To do this, remove the air filters from the indoor device as described above.

- Using a vacuum cleaner or a long-bristled brush,

carefully remove any dirt deposits on the heat exchanger; this will avoid damaging the heat exchanger fins. A damaged heat exchanger will lead to higher operating costs.

- Take steps to ensure that you do not injure yourself on the fin edges!

## 9. General notes

Problem	Cause
After pressing the start key the device is not started by the microprocessor for 3 minutes.	This is not a fault, it is for the protection of the compressor. Please have a little patience.
Crackling noises can be heard.	This is not a fault. These tension noises are caused by the contraction and expansion of the front panel in response to temperature differences.
There is an odd smell in the room.	This is not a fault. The air conditioner also circulates the transpiration from the walls, carpets, smoke, furniture and clothing in the air.
You can hear moving water.	This is not a fault. The coolant in the air conditioner may have expanded.
The air conditioner switches off during heat mode. Heat mode is not possible if the outdoor temperature is below approx. 0°C.	The outdoor device freezes if the outdoor temperature is low (below approx. +0°C).

### Care precautions

If the air conditioner is not going to be used for some period of time:

1. Let the fans run for 3 - 4 hours to allow the device to completely dry out. Set the highest possible temperature level while the fans are running.

2. Switch off the device and pull the power plug.

#### Important:

Always pull out the power plug if the device is not going to be used for some time. Collections of dust pose a fire hazard.

3. Take the batteries out of the remote control.

## 10. Troubleshooting

### Device does not start. Check the following:

1. Is voltage present at the plug socket outlet?
2. Check the plug fuse!
3. Is the timer set?

### The device does not provide satisfactory cooling!

#### Check the following:

1. Has an appropriate temperature been set?

2. Is the air filter soiled? Clean and fit back in place.
3. Are the inlets and outlets on the outdoor device blocked?
4. Has the sleep mode been set during the day?
5. Are the connections between the indoor and outdoor device adequately sealed? There may not be enough coolant? If so, please contact your service company.

### The remote control does not work! (Important! It only works within a range of 8 m from the indoor device.)

1. Are the batteries still OK? Replace if necessary!
2. Have the batteries been inserted correctly? Check that the + and – terminals are correct!

### In the event of a power failure, check the following:

Press the ON/OFF key after a power failure.

If the problems remain after checking through the above points, switch off the device and contact your service company.

The following pages are intended for professional installers.

## 11. Important installation instructions

### Selecting the place to install the indoor device

- The air flow must never be blocked.
- The cooled air should be capable of being distributed to all parts of the room.
- The maximum distance between the indoor and outdoor device for standard versions is 4 m.
- Mount on a solid wall to prevent vibrations.
- Avoid direct sunlight.
- Take into account a slight condensate run-off.

### Selecting the place to install the outdoor device

- The device must not be exposed to strong gusts of wind.
- Make sure that the device is well ventilated and kept free of dust. Avoid direct exposure to rain and sunlight.
- Make sure that the operational noises and air emissions do not cause a nuisance for neighbours.
- Install on a firm base, avoiding excessive noise or vibrations.
- Avoid locations where combustible gas or leakage can be emitted.
- Fix the device's installation feet with care if the device is to be installed well above them.

### Important

Do not hesitate to contact our service partners. They will be able to give you a speedy response to all your questions so that your system can be installed correctly.

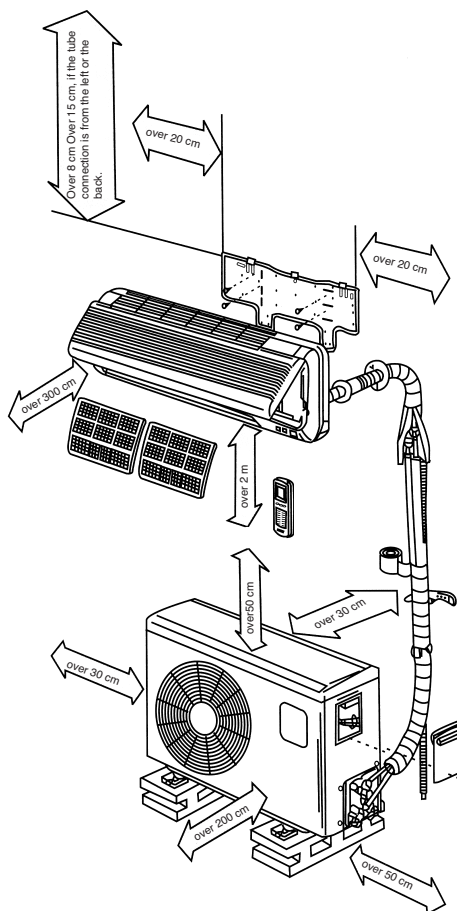

## 12. Installation accessories

Please check that all the installation accessories have been supplied prior to carrying out the installation work.

1 mounting plate for the indoor device



1 infrared remote control



2 batteries (type AAA, 1.5 V)

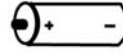

10 screws (4.2 x 25)



1 condensed water hose (L = 2 m)



1x sealing compound

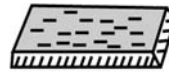

1 wall hole cap



1 roll of plastic wrapping tape



1 set of refrigerant lines (L = 4 m)



1x pipe insulation (Ø 35 x 500 mm)



### 13. Installation instructions:

**Check that the actual mains voltage is the same as the mains voltage specified on the rating plate.**

- The device must have separate protection against short-circuits.
- Have all work of electrical installation performed by an electrician.
- Ask a service partner or specialist cooling system firm to undertake all work of installing the cooling system.
- Incorrect installation can lead to injury or damage to property.
- Always wear ear muffs, goggles and work gloves when performing work of installation.

#### Notes on electrical connection!

All electrical connection work must be performed by a qualified electrician authorized to do so such work by the applicable electricity supply company. The system must have separate protection against short-circuits. Select a suitably large cable cross-section. The yellow/green wire is to be used as a protective conductor only and under no circumstances as a voltage carrying conductor. The fixed electrical connection of the device must be capable of being isolated from the mains power supply by a device with an isolating distance of at least 3mm (e.g. circuit-breaker). Connect the electrical connections of the indoor and outdoor devices together first and then connect to the mains power supply. Check first that the entire system is voltage-free. Secure the system from being switched on again.

#### 1. Selecting the place of installation

##### Indoor device

1. The openings for the inlet and outlet air must never be covered, otherwise the air will not be distributed throughout the entire room.
2. Install the indoor device in a location which ensures that the distance through the wall to the outdoor device is as short as possible.
3. Make sure that the drainage hose does not have any kinks or upward inclines when you connect it with the outside.
4. Do not select a location adjacent to a source of heat, high humidity or inflammable gas.
5. Select a location which is firm enough for installation so that the device is not subjected to vibrations.
6. Check that the device has been installed correctly and exactly.

7. Make sure that there is sufficient space available for later repair and service work.
8. The device should be installed at a distance of at least 1 m from all other electrical devices and installations, e.g. TV, radio, computer, etc.
9. Select a location for the device which is easily accessible so that the filter can be cleaned or replaced without difficulty.

##### Outdoor device

1. Select a location which avoids causing a nuisance to neighbours from noise and air emissions from device.
2. Select a location which is sufficiently well ventilated.
3. Never cover the air inlets and outlets.
4. The location must be sufficiently firm for installation and the prevention of vibrations.
5. There must be no risk presented by combustible gas or gas escaping as a result of corrosion.
6. Check that the device is installed in accordance with regulations.

#### Important:

**The following could cause malfunctions.**

**Check with your service company in order to prevent possible malfunctions at a later date.**

#### The following locations should be avoided for installation:

- A location where oil (machine oil) is stored.
- A location where there is a high salt content.
- A location with numerous sulphurous sources, e.g. spa zones.
- A location where radio transmitters or amplifier aerials, welding equipment or medical equipment are in use.
- A location where the outdoor device is exposed to direct sunlight. If necessary the device must be protected with a sun-shade. Such a sun-shade must not interfere with the air flow, however.
- A location in the vicinity of heat or steam generators.
- A location which is heavily exposed to dust.
- A location to which the general public have access.
- A location with any other unusual characteristics.

#### Important!

- The direction in which the air is blown should correspond with the prevailing direction of the wind.
- Never install in locations exposed to aggressive air.
- Comply with all specified minimum distances

(see Important notes on installation).

- The indoor and outdoor devices must only ever be installed in a vertical position.

## 2. Installing the indoor device

It is imperative that you comply with the installation instructions.

### 2.1 Before you start installation

- Select the location for the indoor device (follow the previous notes on selecting the location for installation).
- Check that the available mains voltage is the same as the voltage specified on the rating plate.
- Fit appropriate insulation, supplied by the customer, to the coolant tubes.

### 2.2 Fitting the mounting plate

- The mounting plate for the indoor device must be fitted horizontally to the wall. In doing so, it is imperative that you comply with all specified distances. Mark and drill the holes for fastening the mounting plate, and then firmly fasten with dowels and screws. In order to prevent vibrations on the indoor device, make sure that there are no gaps between the wall and the mounting plate.

### 2.3 Drilling a hole through the wall

- Drill a hole through the wall for the lines/hoses using a 65 mm drill bit, drilling from the inside to the outside at a downwards angle of approx. 5°.

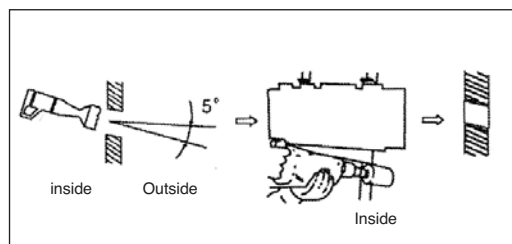

### 2.4 Fitting the condensation water drainage hose

- The drainage water hose must be run to the outside with a drop. It is imperative that there are no bends or kinks. The end of the drainage hose must not be situated in a container of any kind in which water can collect. Any water held back in the drainage water hose could lead to water damage.
- Slide the additional drainage hose onto the mounts on the drainage hose already fixed to the indoor device. Fasten this connection point with adhesive tape, checking that it is fully sealed as you do so. Wrap the section of the drainage hose

in the hole in the wall, plus approx. 10 cm in front of the wall on both the inside and outside, in insulation material.

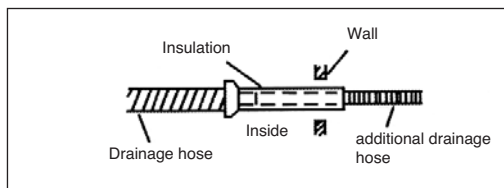

### 2.5 Making the electrical connection to the indoor device

Note that only a qualified electrician approved by the local electricity supply company may make the electrical connection.

- Open the panel of the indoor device.
- Remove the power connection cover (1).
- Connect the connection cables (mains supply and signal cables) for the indoor and outdoor devices as shown. Now pull the connection cables back to the rear of the inner housing and reinstall the power connection cover.
- Close the panel of the indoor device.

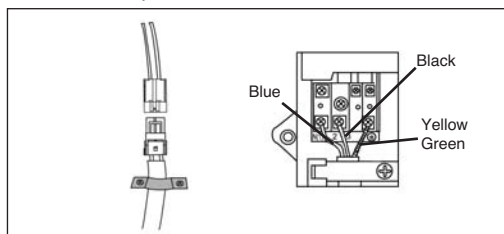

### 2.6 Connecting the refrigerant lines to the indoor device

Route the refrigerant lines from the indoor device to the outdoor device.

- Remove the plastic seals on the refrigerant connection coupling on the indoor device and on the respective refrigerant line.
- Fit the gland on the coolant tube straight on the thread on the indoor device.
- Screw the first turns of the thread by hand in a counterclockwise direction.
- Then use suitably sized open-ended wrenches to tighten the glands. Please refer to the following table for the applicable torque. Check the torque using a torque wrench.

Ø 6 mm tube = 15 - 20 Nm

Ø 12 mm tube = 50 - 55 Nm



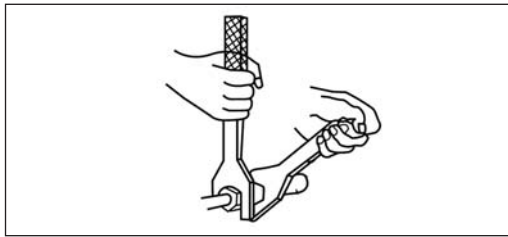

### 2.7 Wrapping the lines/hoses in protective tape

- Please note that the power cable is not to be fed through to the outside. All tubes, electric cables and the drainage water hose have to be wrapped with the supplied protective tape. Depending on whether the lines are right-hand or left-hand versions, the corresponding bushing preparations must be removed from the indoor device.

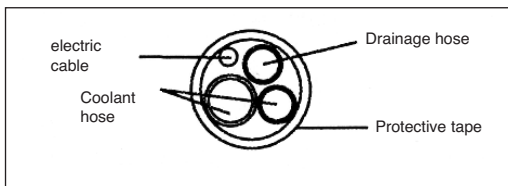

### 2.8 Final installation of the indoor device

- Feed the package of lines/hoses through the hole in the wall.
- Fit the indoor device to the hook at the top of the mounting plate and let it lock into place at the bottom.
- The package of lines/hoses is to be laid between the housing of the indoor device and the wall. In order to prevent condensation water, insulate the package of lines/hoses with heat insulation material.
- Apply the sealing compound between the masonry and the ductwork.
- Fit the wall hole cap over the bundle of lines from the outside.

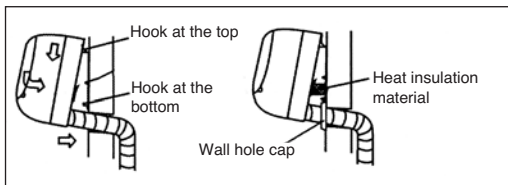

### 3. Installing the outdoor device

It is imperative that you follow the installation instructions.

#### 3.1 Before you start installation

- Select the location for installation (follow the previous notes on selecting the location).
- Check that the available mains voltage is the same as the voltage specified on the rating plate.
- The maximum possible distance between the indoor and the outdoor device using the supplied accessories is 4 m.
- If the outdoor device is higher than the indoor device, make sure that a curve is made in the coolant tube which is lower than the bottom edge of the indoor device.
- Fasten the condensation water drain to the base of the outdoor device.

#### 3.2 Mounting the outdoor device

- The outdoor device can be fastened to the ground or to a wall bracket (e.g. special accessory Art. No. 23.651.55) with dowels and screws. To do so, use the holes on the device.

### 4. Connecting the coolant tubes

#### 4.1 Important notes

- Please make sure that coolant is never allowed to enter the environment.
- Improper handling of coolant may be harmful to health. Always wear work gloves and goggles when handling coolant.
- Make sure that the work place is well ventilated at all times. Smoking is prohibited.
- The device must never be operated without the coolant tubes connected, otherwise the device will be damaged immediately.
- Ask one of our service partners or a specialist cooling system firm to connect the coolant lines and put the system into operation for the first time.

#### Important

1. Have all service work performed by a specialist firm only. Request a copy of our list of service partners for any such work.
2. If ever the voltage carrying cable between the indoor device and the outdoor device should be damaged, contact a specialist firm.
3. If the power cable should ever be damaged, have it replaced by an electrician.
4. Important note:
  - a) The maximum length of the coolant line in the basic version is 4 meters.

b) If the outdoor device is higher than the indoor device, a curve will be required in the coolant tube which is positioned below the height of the indoor device.

## 5. Electrical connection

Important note: All work of making the electrical connection of the system must be undertaken by an electrician.

- Remove the connection cover on the outdoor device.
- Connect the electric cable as shown in the illustration; take account of the ground terminal as you do so.
- Also connect the signal cable and secure to the outdoor device using a cord grip.
- Fit the connection cover back on the outdoor device.

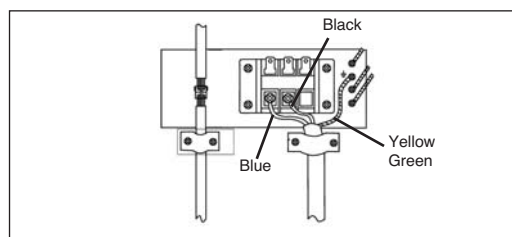

## 14. Initial startup

Initial startup must be performed by an authorized specialist and documented.

### Function check and trial run

The function check is started via the indoor device, which runs in normal cooling mode.

- The following items are checked:
- Tightness of the refrigerant lines
- Steady running of the compressor and fans.
- Output of cold air at the indoor device and warm air at the outdoor section.
- Function check of the indoor device and all program sequences.

ISC GmbH  
Eschenstraße 6  
D-94405 Landau/Isar

## Konformitätserklärung



- (D)** erklärt folgende Konformität gemäß EU-Richtlinie und Normen für Artikel
- (GB)** declares conformity with the EU Directive and standards marked below for the article
- (F)** déclare la conformité suivante selon la directive CE et les normes concernant l'article
- (NL)** verklaart de volgende conformiteit in overeenstemming met de EU-richtlijn en normen voor het artikel
- (E)** declara la siguiente conformidad a tenor de la directiva y normas de la UE para el artículo
- (P)** declara a seguinte conformidade de acordo com a directiva CE e normas para o artigo
- (S)** förklarar följande överensstämmelse enl. EU-direktiv och standarder för artikeln
- (FIN)** ilmoittaa seuraavaa Euroopan unionin direktiivien ja normien mukaista yhdenmukaisuutta tuotteelle
- (DK)** erklærer herved følgende samsvar med EU-direktiv og standarder for artikkel
- (RUS)** заявляет о соответствии товара следующим директивам и нормам ЕС
- (HR)** **izjavljuje sljedeću uskladenost s odredbama i normama EU za artikl.**
- (RO)** declară următoarea conformitate cu linia directoare CE și normele valabile pentru articolul.

- (TR)** ürün ile ilgili olarak AB Yönetmelikleri ve Normları gereğince aşağıdaki uygunluk açıklama masını sunar.
- (GR)** δηλώνει την ακόλουθη συμφωνία σύμφωνα με την Οδηγία ΕΕ και τα πρότυπα για το προϊόν
- (I)** dichiara la seguente conformità secondo la direttiva UE e le norme per l'articolo
- (DK)** attesterer følgende overensstemmelse i henhold til EU-direktiv og standarder for produkt
- (CZ)** **prohlašuje následující shodu podle směrnice EU a norem pro výrobek.**
- (H)** **a következő konformitást jelenti ki a termék-re vonatkozó EU-irányvonalak és normák szerint**
- (SLO)** **pojasnjuje sledečo skladnost po smernici EU in normah za artikel.**
- (PL)** **deklaruje zgodność wymienionego poniżej artykułu z następującymi normami na podstawie dyrektywy WE.**
- (SK)** **vydáva nasledujúce prehlásenie o zhode podľa smernice EÚ a noriem pre výrobok.**
- (BG)** декларира следното съответствие съгласно директивите и нормите на ЕС за продукта.

### Klima-Splitanlage NSK 3500 C+H

- |  |   |
|--|---|
| <input type="checkbox"/> 98/37/EG                        | <input type="checkbox"/> 87/404/EWG       |
| <input checked="" type="checkbox"/> 73/23/EWG_93/68/EEC  | <input type="checkbox"/> R&TTED 1999/5/EG |
| <input type="checkbox"/> 97/23/EG                        | <input type="checkbox"/> 2000/14/EG:      |
| <input checked="" type="checkbox"/> 89/336/EWG_93/68/EEC | <input type="checkbox"/> 95/54/EG:        |
| <input type="checkbox"/> 90/396/EWG                      | <input type="checkbox"/> 97/68/EG:        |
| <input type="checkbox"/> 89/686/EWG                      |   |

**EN 55014-1+A1+A2; EN 55014-2+A1; EN 61000-3-2; EN 61000-3-11;  
EN 60335-1+A11+A1; EN 60335-2-40+A11+A12; EN 50366**

Landau/Isar, den 20.12.2005

  
Weichspilgartner  
Leiter QS Konzern

  
Ensing  
Leiter Technik EC

Art.-Nr.: 23.658.10 I.-Nr.: 01015  
Subject to change without notice

Archivierung: 2365810-14-4155050

# GARANTIEURKUNDE

Auf das in der Anleitung bezeichnete Gerät geben wir 2 Jahre Garantie, für den Fall, dass unser Produkt mangelhaft sein sollte. Die 2-Jahres-Frist beginnt mit dem Gefahrenübergang oder der Übernahme des Gerätes durch den Kunden. Voraussetzung für die Geltendmachung der Garantie ist eine ordnungsgemäße Wartung entsprechend der Bedienungsanleitung sowie die bestimmungsgemäße Benutzung unseres Gerätes.

**Selbstverständlich bleiben Ihnen die gesetzlichen Gewährleistungsrechte innerhalb dieser 2 Jahre erhalten.** Die Garantie gilt für den Bereich der Bundesrepublik Deutschland oder der jeweiligen Länder des regionalen Hauptvertriebspartners als Ergänzung der lokal gültigen gesetzlichen Vorschriften. Bitte beachten Sie Ihren Ansprechpartner des regional zuständigen Kundendienstes oder die unten aufgeführte Serviceadresse.

ISC GmbH · International Service Center  
Eschenstraße 6 · D-94405 Landau/Isar (Germany)  
Info-Tel. 0180-5 120 509 · Telefax 0180-5 835 830  
Service- und Infoserver: <http://www.isc-gmbh.info>

## ® WARRANTY CERTIFICATE

The product described in these instructions comes with a 2 year warranty covering defects. This 2-year warranty period begins with the passing of risk or when the customer receives the product.

For warranty claims to be accepted, the product has to receive the correct maintenance and be put to the proper use as described in the operating instructions.

**Your statutory rights of warranty are naturally unaffected during these 2 years.**

This warranty applies in Germany, or in the respective country of the manufacturer's main regional sales partner, as a supplement to local regulations. Please note the details for contacting the customer service center responsible for your region or the service address listed below.

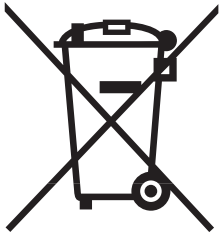

Ⓢ For EU countries only

Never place any electric tools in your household refuse.

To comply with European Directive 2002/96/EC concerning old electric and electronic equipment and its implementation in national laws, old electric tools have to be separated from other waste and disposed of in an environment-friendly fashion, e.g. by taking to a recycling depot.

Recycling alternative to the demand to return electrical devices:

As an alternative to returning the electrical device, the owner is obliged to cooperate in ensuring that the device is properly recycled if ownership is relinquished. This can also be done by handing over the used device to a returns center, which will dispose of it in accordance with national commercial and industrial waste management legislation. This does not apply to the accessories and auxiliary equipment without any electrical components which are included with the used device.





Lined writing area consisting of 25 horizontal lines.

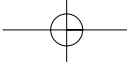
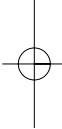
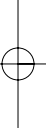



©

The reprinting or reproduction by any other means, in whole or in part, of documentation and papers accompanying products is permitted only with the express consent of ISC GmbH.

EH 12/2005

