

Original operating instructions
Cordless Drill

Einhell®

7



Art.-Nr.: 45.133.63

I.-Nr.: 01019

RT-CD **18 Li**



Change the gear only when the drill is at a standstill. If you fail to observe this point, the gearing may be damaged.

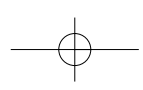
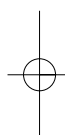
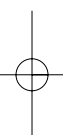

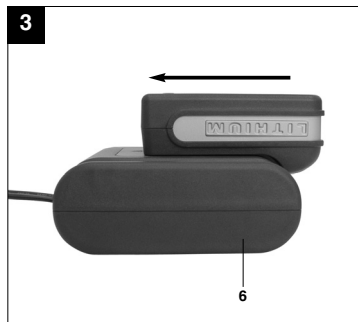

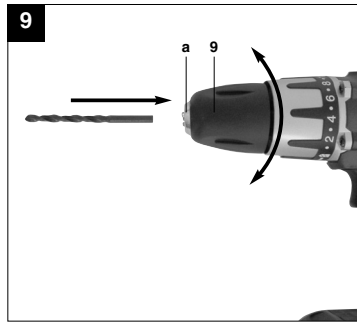
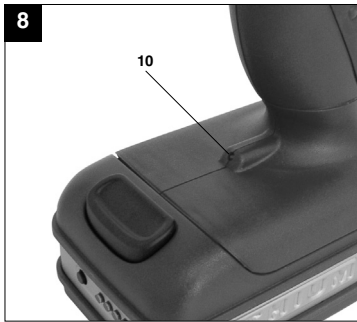
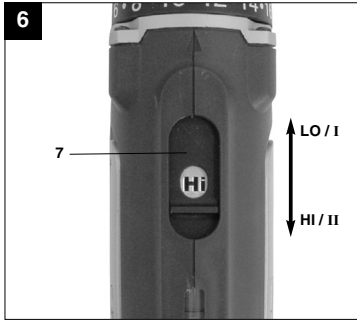
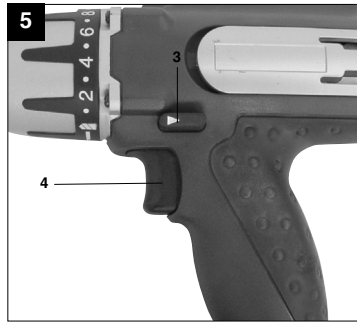



"Caution - Read the operating instructions to reduce the risk of injury"



Wear ear-muffs.
The impact of noise can cause damage to hearing.



Wear a breathing mask.
Dust which is injurious to health can be generated when working on wood and other materials.
Never use the device to work on any materials containing asbestos!



Wear safety goggles.
Sparks generated during working or splinters, chips and dust emitted by the device can cause loss of sight.

GB**⚠ Important!**

When using equipment, a few safety precautions must be observed to avoid injuries and damage. Please read the complete operating manual with due care. Keep this manual in a safe place, so that the information is available at all times. If you give the equipment to any other person, give them these operating instructions as well. We accept no liability for damage or accidents which arise due to non-observance of these instructions and the safety information.

1. Safety information

Please refer to the booklet included in delivery for the safety instructions.

⚠ CAUTION!

Read all safety regulations and instructions.

Any errors made in following the safety regulations and instructions may result in an electric shock, fire and/or serious injury.

Keep all safety regulations and instructions in a safe place for future use.

2. Layout (Fig. 1)

1. Torque selector
2. Battery capacity indicator
3. Changeover switch
4. ON/OFF switch
5. Battery pack
6. Battery charger
7. Selector switch for 1st/2nd gear
8. Pushlock button
9. Quick-change drill chuck
10. LED lamp

3. Proper use

The cordless drill/screwdriver is designed for tightening and undoing screws, as well as for drilling in wood, metal and plastic.

The machine is to be used only for its prescribed purpose. Any other use is deemed to be a case of misuse. The user / operator and not the manufacturer will be liable for any damage or injuries of any kind caused as a result of this.

Please note that our equipment has not been designed for use in commercial, trade or industrial

applications. Our warranty will be voided if the machine is used in commercial, trade or industrial businesses or for equivalent purposes.

4. Technical data

Voltage supply	18 V d.c.
Idling speed:	0-280/0-1200 rpm
Torque settings:	23+1
Forward and reverse rotation	yes
Chuck clamping width	max. 13 mm
Battery charging voltage	21 V d.c.
Battery charging current	450 mA
Mains voltage for charger	230 V ~ 50 Hz
Weight	1.73 kg

Sound and vibration

Sound and vibration values were measured in accordance with EN 60745.

L_{pA} sound pressure level	73 dB(A)
K_{pA} uncertainty	3 dB
L_{WA} sound power level	84 dB(A)
K_{WA} uncertainty	3 dB

Wear ear-muffs.

The impact of noise can cause damage to hearing.

Total vibration values (vector sum of three directions) determined in accordance with EN 60745.

Drilling in metal

Vibration emission value $a_h \leq 2,5 \text{ m/s}^2$

K uncertainty = 1,5 m/s^2

Screwing without hammer action

Vibration emission value $a_h \leq 2,5 \text{ m/s}^2$

K uncertainty = 1,5 m/s^2

⚠ Important!

The vibration value changes according to the area of application of the electric tool and may exceed the specified value in exceptional circumstances.

Keep the noise emissions and vibrations to a minimum.

- Only use appliances which are in perfect working order.
- Service and clean the appliance regularly.
- Adapt your working style to suit the appliance.
- Do not overload the appliance.
- Have the appliance serviced whenever necessary.
- Switch the appliance off when it is not in use.
- Wear protective gloves.

5. Before starting the equipment

Be sure to read the following information before you use your cordless screwdriver for the first time:

1. Charge the battery pack with the charger supplied. An empty battery pack requires a charging period of approximately 3 hours.
2. Only ever use sharp drill bits and screwdriver bits which are suitable for the purpose and in faultless condition.
3. Always check for concealed electric cables and gas and water pipes when drilling and screwing in walls.

6. Operation**6.1 Charging the LI battery pack (Fig. 2-3)**

1. Remove the battery pack (5) from the handle, pressing the pushlock buttons (8) downwards to do so.
2. Check that your mains voltage is the same as that marked on the rating plate of the battery charger. Plug the mains plug of the charger (6) into the mains socket outlet.
3. Push the battery pack onto the battery charger. The flashing green LED will come on to indicate that the battery pack is being charged. When the charging process is finished, the green LED will be permanently lit. The time it takes to fully recharge an empty battery is approximately 3 hours. The temperature of the battery pack may rise slightly during the charging operation. This is normal. If the red LED on the charger is permanently lit, the temperature is either above or below the perfect charging temperature. In this case, pull the plug of the charger and charge the battery in an environment in which the temperature is either warmer or colder. The flashing red LED on the charger indicates that the battery is defective. In this case pull the charger plug immediately and remove the

defective battery. Do not use the defective battery again.

If the battery pack fails to become charged, please check

- whether there is voltage at the socket-outlet
- whether there is proper contact at the charging contacts on the charger.

If the battery still fails to become charged, please return

- the charger
 - the battery pack
- to our Customer Service Department.

To ensure that the LI battery pack provides long service you should take care to recharge it promptly. You must recharge the battery pack when you notice that the power of the cordless screwdriver drops.

6.2 Torque setting (Fig. 4 / Item 1)

The cordless screwdriver is fitted with a mechanical torque selector.

The torque for a specific size of screw is selected with the set-collar (1). The correct torque depends on several factors:

- on the type and hardness of material in question
- on the type and length screws used
- on the requirements needing to be met by the screwed joint.

The clutch disengages with a grating sound to indicate when the set torque is reached.

Important! The tool must be at a standstill when you set the torque with the setting ring.

6.3 Drilling (Fig. 4 / Item 1)

For drilling purposes, move the set-collar to the last step „Drill“. In this setting the slip clutch is inactive. The maximum torque is available in drilling mode.

6.4 Forward/Reverse switch (Fig. 5 / Item 3)

With the slide switch above the On/Off switch you can select the direction of rotation of the battery-powered drill/screwdriver and secure it against being switched on accidentally. You can choose between clockwise and anticlockwise rotation. To avoid causing damage to the gearing it is advisable to change the direction of rotation only when the tool is at a standstill. The On/Off switch is blocked when the slide switch is in centre position.

GB**6.5 On/Off switch (Fig. 5 / Item 4)**

Infinitely variable speed control is possible with the On/Off switch. The further you press the switch, the higher the speed of the battery-powered drill/screwdriver.

6.6 Changing over from 1st gear to 2nd gear (Fig. 6 / Item 7)

You can work at a higher or lower speed depending on the position of the selector switch. To avoid damaging the gear unit you should only change over gears when the tool has stopped.

6.7 Battery capacity indicator (Fig. 7 – Item 2)

Press the battery capacity indicator switch (a). The battery capacity indicator (2) shows the charge status of the battery using 4 LEDs.

All LEDs are lit:

The battery is fully charged.

2 or 3 LEDs are lit:

The battery has an adequate remaining charge.

One LED is lit:

The battery is discharged, it requires charging. If the battery is being charged, the indicator lights will flash on and off.

Description of the indicator during operation:

L1-L4 flash:

- The overload guard on the battery has tripped. In this case release the ON/OFF switch (4) and then press it again.
- Or the battery is discharged. Recharge the battery.

L2 and L4 flash alternately:

The battery temperature is too high. In this case switch off the cordless screwdriver and allow the tool to cool. The tool can then be used again.

L4 flashes:

The battery capacity is less than 10%.

6.8 LED lamp (Fig. 8)

The LED lamp (10) can be used in poor lighting conditions to illuminate the area where you want to drill or screw. The LED lamp (10) will be lit automatically as soon as you press the ON/OFF switch (4).

6.9 Changing the tool (Fig. 9)

Important. Set the changeover switch (3) to its centre position whenever you carry out any work (for example changing the tool, maintenance work, etc.) on the cordless screwdriver.

- The cordless screwdriver is fitted with a quick-action chuck (9) with an automatic spindle stop.
- Open the chuck (9). The chuck opening (a) must be large enough to hold the tool (drill bit or screwdriver bit).
- Select the suitable tool. Push the tool as far as possible into the chuck opening (a).
- Tighten the chuck (9) and then check that the tool is secure.

6.10 Screwdriving

We recommend using self-centering screws (e.g. Torx screws, recessed head screws) designed for reliable working. Be sure to use a bit that matches the screw in shape and size. Set the torque, as described elsewhere in these operating instructions, to suit the size of screw.

7. Cleaning, maintenance and ordering of spare parts

Always pull out the mains power plug before starting any cleaning work.

7.1 Cleaning

- Keep all safety devices, air vents and the motor housing free of dirt and dust as far as possible. Wipe the equipment with a clean cloth or blow it with compressed air at low pressure.
- We recommend that you clean the device immediately each time you have finished using it.
- Clean the equipment regularly with a moist cloth and some soft soap. Do not use cleaning agents or solvents; these could attack the plastic parts of the equipment. Ensure that no water can seep into the device.

7.2 Maintenance

There are no parts inside the equipment which require additional maintenance.



7.3 Ordering replacement parts

Please quote the following data when ordering replacement parts:

- Type of machine
- Article number of the machine
- Identification number of the machine
- Replacement part number of the part required

For our latest prices and information please go to www.isc-gmbh.info

8. Disposal and recycling

The unit is supplied in packaging to prevent its being damaged in transit. This packaging is raw material and can therefore be reused or can be returned to the raw material system.

The unit and its accessories are made of various types of material, such as metal and plastic. Defective components must be disposed of as special waste. Ask your dealer or your local council.

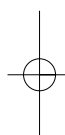
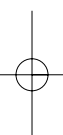

©

The reprinting or reproduction by any other means, in whole or in part, of documentation and papers accompanying products is permitted only with the express consent of ISC GmbH.

• Technical changes subject to change

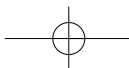



Multiple horizontal lines, likely representing a list or a structured text area, spanning most of the width of the page.

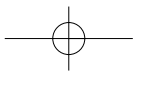
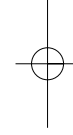

GUARANTEE CERTIFICATE

Dear Customer,

All of our products undergo strict quality checks to ensure that they reach you in perfect condition. In the unlikely event that your device develops a fault, please contact our service department at the address shown on this guarantee card. Of course, if you would prefer to call us then we are also happy to offer our assistance under the service number printed below. Please note the following terms under which guarantee claims can be made:

1. These guarantee terms cover additional guarantee rights and do not affect your statutory warranty rights. We do not charge you for this guarantee.
2. Our guarantee only covers problems caused by material or manufacturing defects, and it is restricted to the rectification of these defects or replacement of the device. Please note that our devices have not been designed for use in commercial, trade or industrial applications. Consequently, the guarantee is invalidated if the equipment is used in commercial, trade or industrial applications or for other equivalent activities. The following are also excluded from our guarantee: compensation for transport damage, damage caused by failure to comply with the installation/assembly instructions or damage caused by unprofessional installation, failure to comply with the operating instructions (e.g. connection to the wrong mains voltage or current type), misuse or inappropriate use (such as overloading of the device or use of non-approved tools or accessories), failure to comply with the maintenance and safety regulations, ingress of foreign bodies into the device (e.g. sand, stones or dust), effects of force or external influences (e.g. damage caused by the device being dropped) and normal wear resulting from proper operation of the device. This applies in particular to rechargeable batteries for which we nevertheless issue a guarantee period of 12 months.

The guarantee is rendered null and void if any attempt is made to tamper with the device.
3. The guarantee for the rechargeable battery is valid for a period of 1 year, and the guarantee for the tool itself is valid for a period of 2 years starting from the purchase date of the device. Guarantee claims should be submitted before the end of the guarantee period within two weeks of the defect being noticed. No guarantee claims will be accepted after the end of the guarantee period. The original guarantee period remains applicable to the device even if repairs are carried out or parts are replaced. In such cases, the work performed or parts fitted will not result in an extension of the guarantee period, and no new guarantee will become active for the work performed or parts fitted. This also applies when an on-site service is used.
4. In order to assert your guarantee claim, please send your defective device postage-free to the address shown below. Please enclose either the original or a copy of your sales receipt or another dated proof of purchase. Please keep your sales receipt in a safe place, as it is your proof of purchase. It would help us if you could describe the nature of the problem in as much detail as possible. If the defect is covered by our guarantee then your device will either be repaired immediately and returned to you, or we will send you a new device.

Of course, we are also happy offer a chargeable repair service for any defects which are not covered by the scope of this guarantee or for units which are no longer covered. To take advantage of this service, please send the device to our service address.

Poweron Imports Limited
17 Lorien Place
East Tamaki
Manukau City 2161
Auckland
Telephone (09) 2746950