

ozito

SPRAY GUN

500W

INSTRUCTION MANUAL

SPECIFICATIONS

Voltage:	220-240V ~ 50Hz
Power:	500W
Max. Flow Rate:	550ml/min
Max Viscosity:	60 DIN-sec
Container Capacity:	1000ml
Nozzle:	ø2.0 / ø2.5mm
Weight:	1.45kg

ozito.com.au

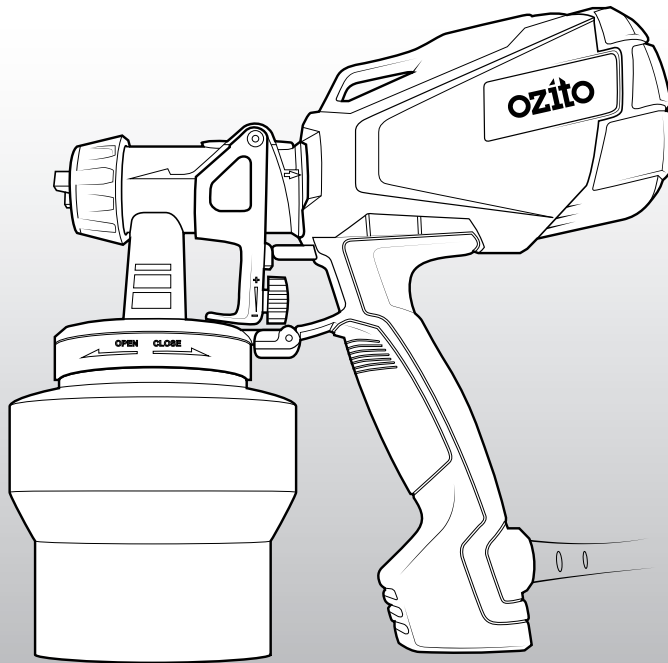

WHAT'S IN THE BOX



Spray Gun



Viscosity Cup

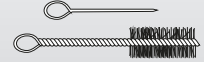

Cleaning Needle & Brush

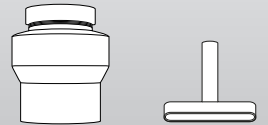

Paint Pot & Needle Tool

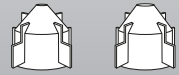

2 x Nozzles

1 YEAR REPLACEMENT WARRANTY

SGP-5000

WARRANTY

IN ORDER TO MAKE A CLAIM UNDER THIS WARRANTY YOU MUST RETURN THE PRODUCT TO YOUR NEAREST BUNNINGS WAREHOUSE WITH YOUR BUNNINGS REGISTER RECEIPT. PRIOR TO RETURNING YOUR PRODUCT FOR WARRANTY PLEASE TELEPHONE OUR CUSTOMER SERVICE HELPLINE:

Australia 1800 069 486

New Zealand 0508 069 486

TO ENSURE A SPEEDY RESPONSE PLEASE HAVE THE MODEL NUMBER AND DATE OF PURCHASE AVAILABLE. A CUSTOMER SERVICE REPRESENTATIVE WILL TAKE YOUR CALL AND ANSWER ANY QUESTIONS YOU MAY HAVE RELATING TO THE WARRANTY POLICY OR PROCEDURE.

The benefits provided under this warranty are in addition to other rights and remedies which are available to you at law.

Our goods come with guarantees that cannot be excluded at law. You are entitled to a replacement or refund for a major failure and for compensation for any other reasonably foreseeable loss or damage. You are also entitled to have the goods repaired or replaced if the goods fail to be of acceptable quality and the failure does not amount to a major failure.

Generally you will be responsible for all costs associated with a claim under this warranty, however, where you have suffered any additional direct loss as a result of a defective product you may be able to claim such expenses by contacting our customer service helpline above.

1 YEAR REPLACEMENT WARRANTY

Your product is guaranteed for a period of **12 months from the original date of purchase** and is intended for DIY (Do It Yourself) use only. If a product is defective it will be replaced in accordance with the terms of this warranty. Warranty excludes consumable parts, for example: viscosity cup, cleaning needle, nozzle, paint pot.

WARNING

The following actions will result in the warranty being void.

- If the tool has been operated on a supply voltage other than that specified on the tool.
- If the tool shows signs of damage or defects caused by or resulting from abuse, accidents or alterations.
- Failure to perform maintenance as set out within the instruction manual.
- If the tool is disassembled or tampered with in any way.
- Professional, industrial or high frequency use.

KNOW YOUR PRODUCT

SPRAY GUN

- | | |
|------------------------|--------------------|
| 1 Nozzle | 6 Paint Pot |
| 2 Air Cap | 7 Locking Lever |
| 3 Paint Head | 8 Soft Grip Handle |
| 4 On/Off Trigger | 9 Spray Gun Body |
| 5 Spray Regulator Dial | 10 Air filter |

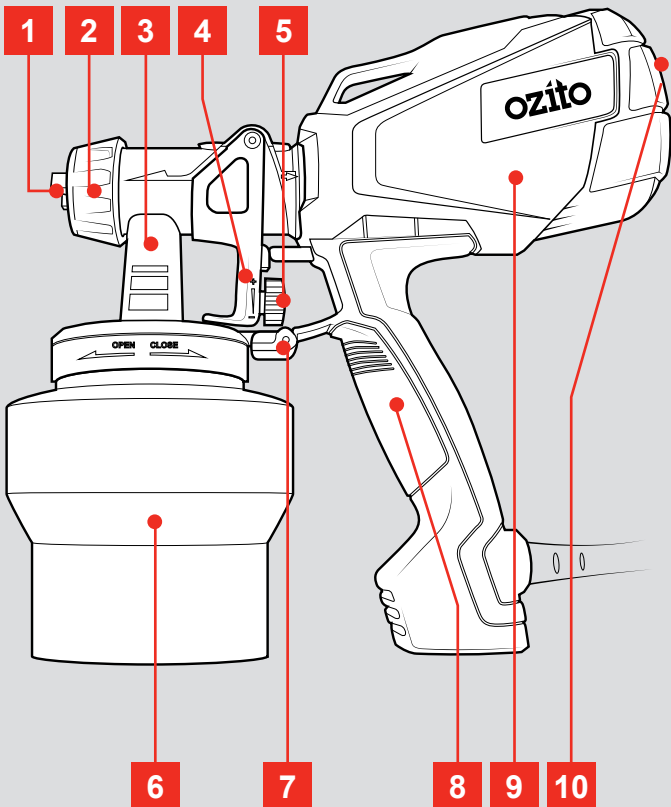

ACCESSORIES

- | | |
|--------------------|------------------------------|
| 11 Cleaning Needle | 14 Nozzles x 2 |
| 12 Cleaning Brush | 15 Paint Pot Lid |
| 13 Viscosity Cup | 16 Fluid Needle Removal Tool |

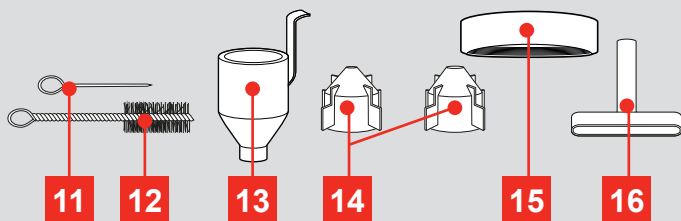

ONLINE MANUAL

Scan this QR Code with your mobile device to take you to the online manual.



SETUP & PREPARATION

1. ASSEMBLY

WARNING! ENSURE THE TOOL IS DISCONNECTED FROM THE POWER SUPPLY BEFORE PERFORMING ANY OF THE FOLLOWING OPERATIONS.

Inserting the Paint Head

- 1 Insert the paint head into the gun body by aligning the arrows on the neck of the paint head and body.

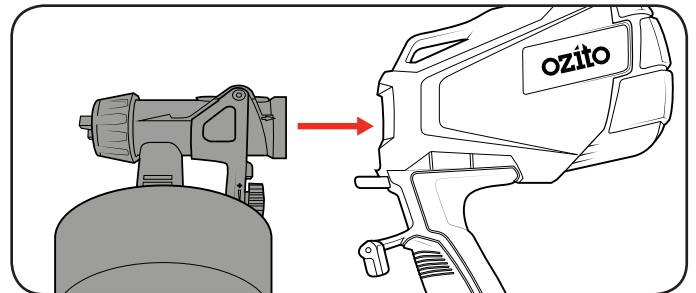

Note: Ensure the locking lever is rotated out of the way to avoid damaging the locking lever.

- 2 Rotate the paint head clockwise into the correct orientation.
- 3 Rotate the locking lever forward to secure the paint head.

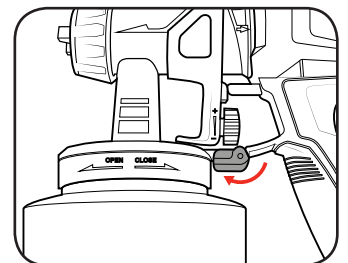
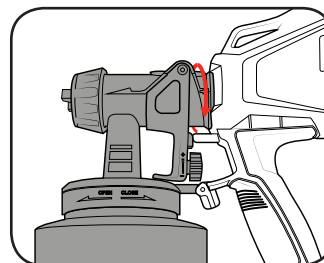

Aligning the Suction Tube

- 1 When spraying horizontal or low objects turn the suction tube to the front.
- 2 When spraying overhead objects turn the suction tube to the back.

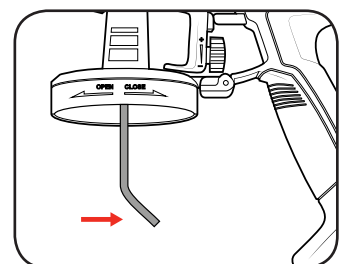
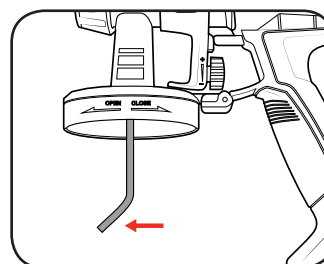

1 YEAR WARRANTY

OPERATION

2. PREPARATION

NOTE: FOR BEST RESULTS, SURFACE PREPARATION AND PAINT THINNING ARE THE TWO MOST IMPORTANT AREAS. ENSURE ALL SURFACES ARE FREE OF DUST, DIRT AND GREASE.

Thinning

Thinning is particularly important when spraying. Most paints are supplied ready for brush application and need to be diluted sufficiently for spraying purposes.

Note: Water based paints can be thinned using water.

Follow the manufacturers guide for thinning ratios which should be labelled on the paint container.

- 1 Before pouring any paint or thinners, work out how much of each substance is needed.
- 2 Pour the required paint and thinners using a filter into a mixing cup and mix thoroughly.

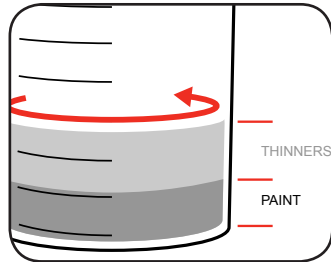
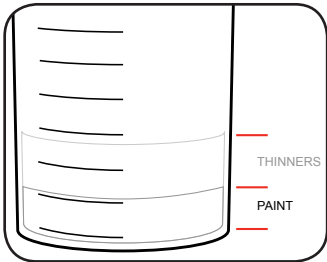

Determining Viscosity

It is vital to determine the viscosity of the coating material to see if it is suitable to be used in the spray gun.

- 1 Submerge the viscosity cup into the material to fill.
- 2 Raise the cup out of the material and start timing.

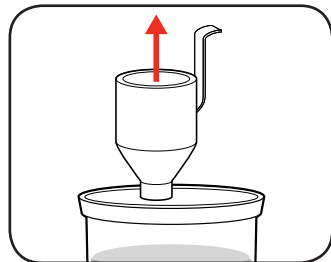
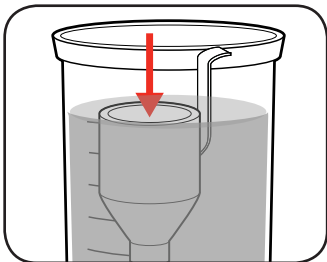

- 3 Time how long it takes to empty the cup. This is referred to as DIN seconds.
- 4 If the material is above 60 DIN-sec the material will need to be thinned more and retested.

(IMPORTANT!) THE SPRAY GUN CANNOT BE USED WITH MATERIALS CONTAINING ABRASIVE SUBSTANCES, GLAZES, DISPERSION PAINTS, CAUSTIC AND ALKALINE SUBSTANCES, TEXTURED COATINGS OR TOXIC SPRAYS.

3. CONTROLS



CAUTION: TO REDUCE THE RISK OF ELECTRICAL SHOCK, A RESIDUAL CURRENT DEVICE (RATED 30MA OR LESS) MUST BE USED.

On/Off Trigger

- 1 Squeeze the on/off trigger to start spraying.
- 2 Release the on/off trigger to stop spraying.

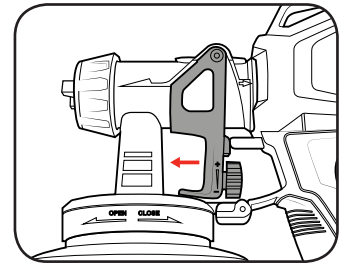
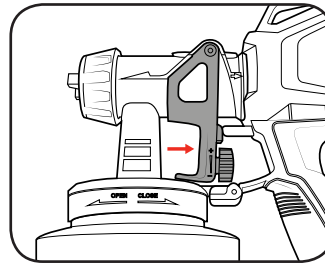

Spray Regulator Dial

The regulator dial is a stop that limits the distance the trigger can be pressed. This results in less material being sprayed.

- 1 Squeeze the trigger while aiming at a piece of cardboard or scrap.
- 2 Rotate the regulator dial to the required position for optimal results.

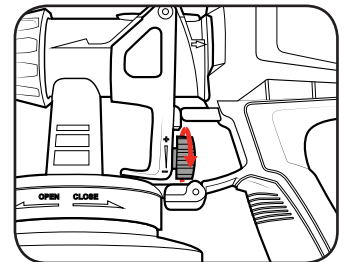
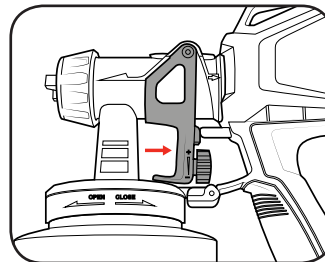

Replacing Air Filter

- 1 Remove the filter cover by removing the 4 screws with a screwdriver.
- 2 Wash or replace the dirty filter and place inside the inner cover.

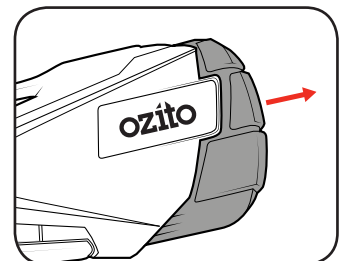
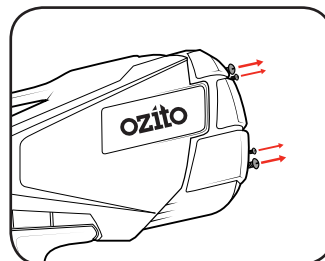

- 3 Secure the filter cover back onto the spray gun with the 4 screws.



WARNING! NEVER OPERATE THE SPRAY GUN WITHOUT A FILTER. DIRT COULD BE SUCKED IN AND DAMAGE THE OPERATION OF THE UNIT.

4. ADJUSTING THE SPRAY GUN

Choosing Spray Patterns

To change spray patterns simply loosen the air cap and rotate to the desired position. Ensure that the air cap is tightened again to secure in place.

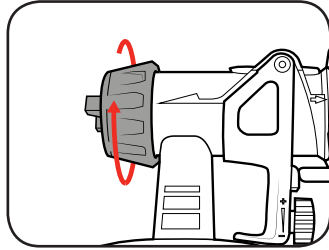

1 For vertical surfaces use a horizontal fan. This is done by rotating the air cap into the position shown to the right.

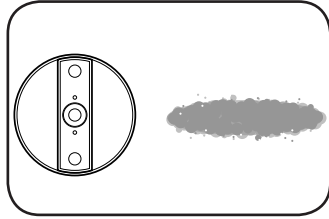

2 For horizontal surfaces use a vertical fan. This is done by rotating the air cap into the position shown to the right.

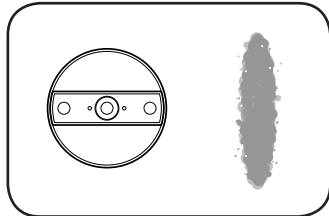

3 For corners, edges and other hard to access places use a round fan. This is done by rotating the air cap into the position shown to the right.

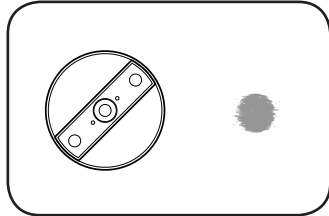

Changing Nozzles

2 sized nozzles are provided with this spray gun. The 2mm diameter nozzle (colour: red) should be used for lower viscosity materials. The 2.5mm diameter nozzle (colour: black) should be used for higher viscosity materials.

1 Unscrew and remove the air cap from the paint head.

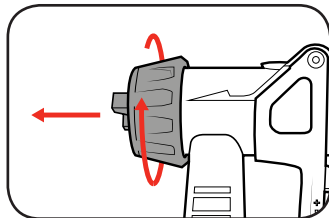

2 Remove the nozzle and replace with the desired size. Screw the air cap onto the paint head to secure the nozzle.

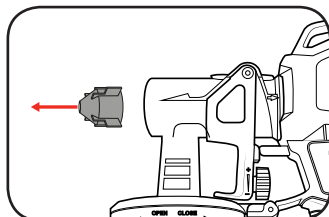

5. HOW TO SPRAY

WARNING: NEVER UNDER ANY CIRCUMSTANCES AIM THE NOZZLE AT ANOTHER PERSON OR ANIMAL. THE HIGH PRESSURE AT THE NOZZLE COULD CAUSE INJURY.

CAUTION: PROTECTIVE CLOTHING SHOULD BE WORN DURING OPERATION TO AVOID INJURY.

1 Ensure the paint and thinners has been thoroughly mixed.

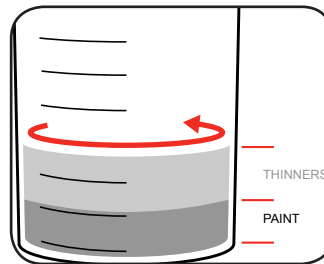

2 Ensure the viscosity of the mixture is less than 60 DIN-S.

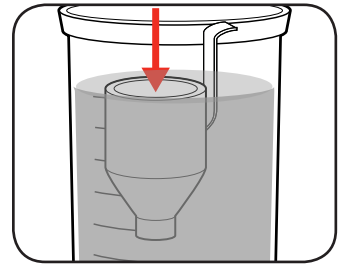

3 Adjust the suction tube and air cap into the desired position for the job.

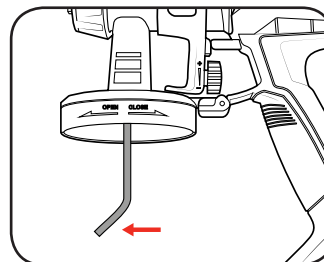

4 Spray onto scrap material to check that the spray pattern is correct.

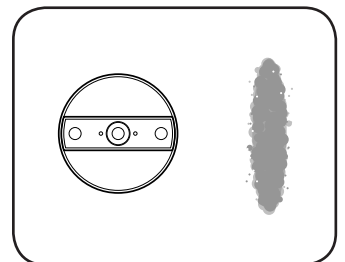

5 Start away from your workpiece and evenly control the speed of movement while maintaining distance and angle to the piece.

6 Overlap each stroke by 2cm to achieve an even coat.

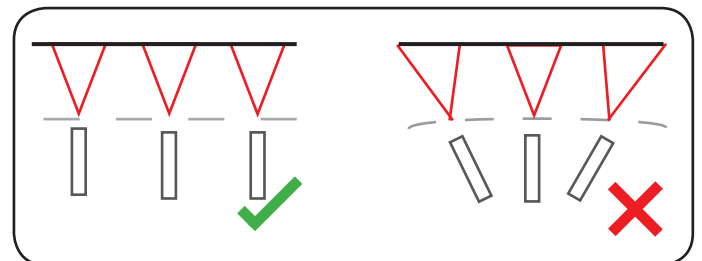

MAINTENANCE

WARNING! ENSURE THE TOOL IS DISCONNECTED FROM THE POWER SUPPLY BEFORE PERFORMING ANY OF THE FOLLOWING OPERATIONS.

After each use it is essential that the spray gun is cleaned thoroughly. This will prevent any blockages occurring and provide reliable performance when you next come to use it.

Cleaning

1 Unscrew the paint pot and return remaining material into a container.

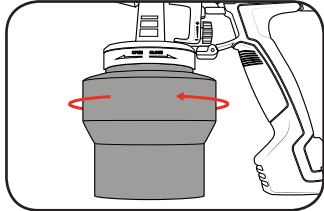

2 Fill the paint pot with solvent or water. *Note: Use only non-flammable liquids*

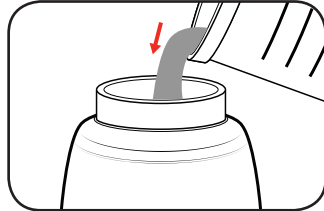

3 Clean the paint pot and suction tube with a brush and then screw the pot back into the gun.

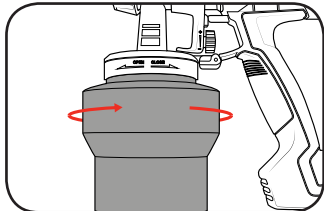

4 Plug the gun back in and spray the solvent into a container. Repeat until clear solvent comes out.

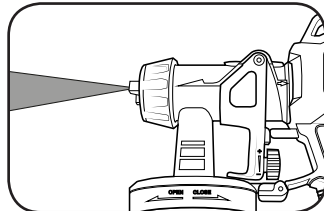

5 Remove the paint pot and empty any remaining solvent.

Cleaning Parts

1 Unscrew the air cap nut to remove the air cap and nozzle.

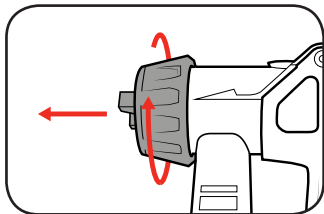

2 Insert the fluid needle removal tool over the needle. Rotate 90 degrees and then pull firmly to remove the needle.

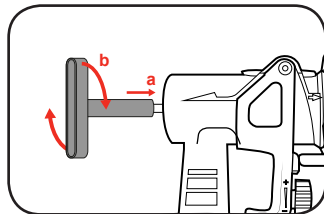

3 Unlock the locking lever and rotate the paint head anti-clockwise until the arrows on the neck of the paint head and body align.

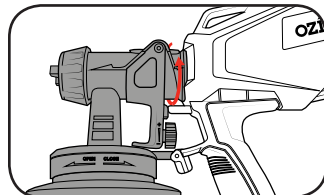

4 Remove the paint head from the body and dismantle the paint pot and suction tube.

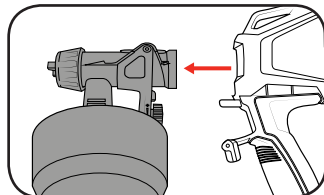

5 Dip a cloth in solvent or water and clean the air cap, nozzle, rear of the paint head and suction tube.

6 Take note of the holes on the air cap and nozzle, if blocked clean using the provided cleaning needle.

7 Prior to storing the spray gun, ensure it is completely dry.

- Keep the vents of the spray gun clean at all times. If possible, prevent foreign matter from entering the vents.
- If the body of the spray gun requires cleaning, do not use solvents but a moist soft cloth only. Never let any liquid get inside the gun body; never immerse any part of the spray gun into a liquid.

Note: Ozito Industries will not be responsible for any damage or injuries caused by the repair of the sander by an unauthorised person or by mishandling of the spray gun.

TROUBLE SHOOTING

Problem	Cause	Remedy
Little or no material flow	Nozzle / Suction tube clogged Spray regulator dial to low Suction tube loose No pressure build up in paint pot Air filter clogged	Clean Increase regulator dial Insert Tighten paint pot Clean or replace
Material leaking	Nozzle loose Nozzle worn Material build up on air cap and nozzle	Tighten Replace Clean
Atomization is too coarse	Viscosity of material too high Material volume too large Nozzle clogged Air filter clogged Too little pressure build up in container	Thin material Decrease spray regulator dial Clean Clean or replace Tighten paint pot
Spray jet pulsates	Material in paint pot running out Air filter clogged	Refill Clean or replace
Pattern runs or sags	Applying to much material	Decrease spray regulator dial or increase movement speed
Too much overspray	Gun too far from spray object Too much material applied	Reduce distance Decrease spray regulator dial
Pattern is very light and splotchy	Moving the spray gun to fast	Decrease spray regulator dial or decrease movement speed

DESCRIPTION OF SYMBOLS

V	Volts	Hz	Hertz
~	Alternating current	W	Watts
°C	Degrees Celsius	BAR	Pressure rating
/min	Revolutions or reciprocation per minute		
	Regulatory Compliance Mark (RCM)		Double insulated
	Do not use in raining		Wear eye, breathing, ear protection
	Read instruction manual		Warning

SPARE PARTS

Spare parts can be ordered from the Special Orders Desk at your local Bunnings Warehouse.

For further information, or any parts not listed here, visit www.ozito.com.au or contact Ozito Customer Service:

Australia 1800 069 486

New Zealand 0508 069 486

E-mail: enquires@ozito.com.au

CARING FOR THE ENVIRONMENT



Power tools that are no longer usable should not be disposed of with household waste but in an environmentally friendly way. Please recycle where facilities exist. Check with your local council authority for recycling advice.



Recycling packaging reduces the need for landfill and raw materials. Reuse of recycled material decreases pollution in the environment. Please recycle packaging where facilities exist. Check with your local council authority for recycling advice.

ELECTRICAL SAFETY

 **WARNING!** When using mains-powered tools, basic safety precautions, including the following, should always be followed to reduce risk of fire, electric shock, personal injury and material damage.

Read the whole manual carefully and make sure you know how to switch the tool off in an emergency, before operating the tool.

Save these instructions and other documents supplied with this tool for future reference.

The electric motor has been designed for 230V and 240V only. Always check that the power supply corresponds to the voltage on the rating plate.

Note: The supply of 230V and 240V on Ozito tools are interchangeable for Australia and New Zealand.



This tool is double insulated therefore no earth wire is required.

If the supply cord is damaged, it must be replaced by the manufacturer, its service agent or similarly qualified persons in order to avoid a hazard.

Note: Double insulation does not take the place of normal safety precautions when operating this tool. The insulation system is for added protection against injury resulting from a possible electrical insulation failure within the tool.

Using an Extension Lead

Always use an approved extension lead suitable for the power input of this tool. Before use, inspect the extension lead for signs of damage, wear and ageing. Replace the extension lead if damaged or defective.

When using an extension lead on a reel, always unwind the lead completely. Use of an extension lead not suitable for the power input of the tool or which is damaged or defective may result in a risk of fire and electric shock.

To reduce the risk of electrical shock, a residual current device (rated 30mA or less) must be used.

GENERAL POWER TOOL SAFETY WARNINGS

 **WARNING!** Read all safety warnings and all instructions. Failure to follow the warnings and instructions may result in electric shock, fire and/or serious injury. Save all warnings and instructions for future reference. The term “power tool” in the warnings refers to your mains-operated (corded) power tool or battery-operated (cordless) power tool.

1. Work area safety

- Keep work area clean and well lit. Cluttered or dark areas invite accidents.
- Do not operate power tools in explosive atmospheres, such as in the presence of flammable liquids, gases or dust. Power tools create sparks which may ignite the dust or fumes.
- Keep children and bystanders away while operating a power tool. Distractions can cause you to lose control.

2. Electrical safety

- Power tool plugs must match the outlet. Never modify the plug in any way. Do not use any adapter plugs with earthed (grounded) power tools. Unmodified plugs and matching outlets will reduce risk of electric shock.
- Avoid body contact with earthed or grounded surfaces, such as pipes, radiators, ranges and refrigerators. There is an increased risk of electric shock if your body is earthed or grounded.
- Do not expose power tools to rain or wet conditions. Water entering a power tool will increase the risk of electric shock.
- Do not abuse the cord. Never use the cord for carrying, pulling or unplugging the power tool. Keep cord away from heat, oil, sharp edges or moving parts. Damaged or entangled cords increase the risk of electric shock.
- When operating a power tool outdoors, use an extension cord suitable for outdoor use. Use of a cord suitable for outdoor use reduces the risk of electric shock.
- If operating a power tool in a damp location is unavoidable, use a residual current device (RCD) protected supply. Use of an RCD reduces the risk of electric shock.

3. Personal safety

- Stay alert, watch what you are doing and use common sense when operating a power tool. Do not use a power tool while you are tired or under the influence of drugs, alcohol or medication. A moment of inattention while operating power tools may result in serious personal injury.
- Use personal protective equipment. Always wear eye protection. Protective equipment such as dust mask, non-skid safety shoes, hard hat, or hearing protection used for appropriate conditions will reduce personal injuries.
- Prevent unintentional starting. Ensure the switch is in the off-position before connecting to power source and/or battery pack, picking up or carrying the tool. Carrying power tools with your finger on the switch or energising power tools that have the switch on invites accidents.

- Remove any adjusting key or wrench before turning the power tool on. A wrench or a key left attached to a rotating part of the power tool may result in personal injury.
 - Do not overreach. Keep proper footing and balance at all times. This enables better control of the power tool in unexpected situations.
 - Dress properly. Do not wear loose clothing or jewellery. Keep your hair, clothing and gloves away from moving parts. Loose clothes, jewellery or long hair can be caught in moving parts.
 - If devices are provided for the connection of dust extraction and collection facilities, ensure these are connected and properly used. Use of dust collection can reduce dust-related hazards.
- ## 4. Power tool use and care
- Do not force the power tool. Use the correct power tool for your application. The correct power tool will do the job better and safer at the rate for which it was designed.
 - Do not use the power tool if the switch does not turn it on and off. Any power tool that cannot be controlled with the switch is dangerous and must be repaired.
 - Disconnect the plug from the power source and/or the battery pack from the power tool before making any adjustments, changing accessories, or storing power tools. Such preventive safety measures reduce the risk of starting the power tool accidentally.
 - Store idle power tools out of the reach of children and do not allow persons unfamiliar with the power tool or these instructions to operate the power tool. Power tools are dangerous in the hands of untrained users.
 - Maintain power tools. Check for misalignment or binding of moving parts, breakage of parts and any other condition that may affect the power tool's operation. If damaged, have the power tool repaired before use. Many accidents are caused by poorly maintained power tools.
 - Keep cutting tools sharp and clean. Properly maintained cutting tools with sharp cutting edges are less likely to bind and are easier to control.
 - Use the power tool, accessories and tool bits etc. in accordance with these instructions, taking into account the working conditions and the work to be performed. Use of the power tool for operations different from those intended could result in a hazardous situation.
- ## 5. Service
- Have your power tool serviced by a qualified repair person using only identical replacement parts. This will ensure that the safety of the power tool is maintained.

SPRAY GUN SAFETY WARNINGS

 **WARNING!**

Hold power tool by insulated gripping surfaces, when performing an operation where the cutting accessory may contact hidden wiring or its own cord. Cutting accessory contacting a “live” wire may make exposed metal parts of the power tool “live” and could give the operator an electric shock.

This appliance is not intended for use by persons (including children) with reduced physical, sensory or mental capabilities, or lack of experience and knowledge, unless they have been given supervision or instruction concerning use of the appliance by a person responsible for their safety.

Using an Extension Lead

Always use an approved extension lead suitable for the power input of this tool. Before use, inspect the extension lead for signs of damage, wear and ageing. Replace the extension lead if damaged or defective.

When using an extension lead on a reel, always unwind the lead completely. Use of an extension lead not suitable for the power input of the tool or which is damaged or defective may result in a risk of fire and electric shock.

It is recommended that the extension lead is a maximum of 25m in length. Do Not use multiple extension leads.

NEVER under any circumstances aim the nozzle at another person or animal.

- In the event of an injury occurring, seek medical advice immediately.
- The spray gun must not be used for spraying flammable liquids.
- Always ensure there is adequate ventilation when spraying.
- The use of ear protection is recommended.
- Eye protection is recommended to keep hazardous vapours and liquids out of eyes.
- Always wear a face mask when spraying.
- Always read the paint manufacturers thinning instructions before using.
- Always keep the spray basket nozzle in place during use. Never allow the spray to come in direct contact with the skin.

 **DANGER!** Never immerse the spray gun in liquid. This could lead to electric shock, personal injury and material damage.

- The spray gun must not be cleaned by using flammable liquids.

NEVER spray near a naked flame, including an appliance pilot light.

NEVER smoke whilst spraying.

NEVER allow children to operate or play with the spray gun.

Before cleaning, always disconnect the appliance from the mains supply.

- Always disconnect from mains supply when refilling the paint pot.

After every use ensure you clean your spray gun thoroughly.

NEVER use the spray gun outside when it is raining.