

MAINTENANCE

- Keep the ventilation vents of the multipurpose saw clean at all times, if possible, prevent foreign matter from entering the vents.
- After each use, blow air through the multipurpose saw housing to ensure it is free from all dust particles which may build up. Build up of dust particles may cause the multipurpose saw to overheat and fail.
- If the enclosure of the multipurpose saw requires cleaning, do not use solvents but a moist soft cloth only. Never let any liquid get inside the multipurpose saw; never immerse any part of the multipurpose saw into a liquid.

Carbon Brushes



When the carbon brushes wear out, the multipurpose saw will spark and/or stop. Discontinue use as soon as this happens. They should be replaced prior to recommencing use of the multipurpose saw. Carbon brushes are a wearing component of the multipurpose saw therefore not covered under warranty. Continuing to use the multipurpose saw when carbon brushes need to be replaced may cause permanent damage to the multipurpose saw. Carbon brushes will wear out after many uses but when the carbon brushes need to be replaced, take the multipurpose saw to an electrician or a power tool repairer for a quick and low cost replacement. Always replace both carbon brushes at the same time.

Note: Ozito Industries will not be responsible for any damage or injuries caused by the repair of the multipurpose saw by an unauthorised person or by mishandling of the multipurpose saw.

DESCRIPTION OF SYMBOLS

V	Volts	Hz	Hertz
~	Alternating current	W	Watts
/min	Revolutions or reciprocation per minute	n	No load speed
	Double insulated		Maximum cutting cap for timber
	Warning		Wear ear protection
	Read instruction manual		Wear face mask
	Wear eye protection		

TROUBLE SHOOTING

The on/off trigger is locked.

Ensure you have correctly held the lock-off switch (located on the on/off trigger) down.

SPARE PARTS

Spare parts can be ordered from the Special Orders Desk at your local Bunnings Warehouse or Homebase store.

For further information, or any parts visit

www.ozito-diy.co.uk or contact Ozito Customer Service:

Great Britain: 0151 294 4488

Ireland: 1850 882711

E-mail: enquires@ozito-diy.co.uk

ELECTRICAL SAFETY

WARNING! When using mains-powered tools, basic safety precautions, including the following, should always be followed to reduce risk of fire, electric shock, personal injury and material damage.

Read the whole manual carefully and make sure you know how to switch the tool off in an emergency, before operating the tool.

Save these instructions and other documents supplied with this tool for future reference.

Before you connect the equipment to the mains supply make sure that the data on the rating plate are identical to the mains data.



This tool is double insulated therefore no earth wire is required.

GENERAL POWER TOOL SAFETY WARNINGS

WARNING! Read all safety warnings and all instructions. Failure to follow the warnings and instructions may result in electric shock, fire and/or serious injury.

Save all warnings and instructions for future reference. The term "power tool" in the warnings refers to your mains-operated (corded) power tool or battery-operated (cordless) power tool.

- Work area safety**
 - Keep work area clean and well lit.** Cluttered or dark areas invite accidents.
 - Do not operate power tools in explosive atmospheres, such as in the presence of flammable liquids, gases or dust.** Power tools create sparks which may ignite the dust or fumes.
 - Keep children and bystanders away while operating a power tool.** Distractions can cause you to lose control.
- Electrical safety**
 - Power tool plugs must match the outlet. Never modify the plug in any way. Do not use any adapter plugs with earthed (grounded) power tools.** Unmodified plugs and matching outlets will reduce risk of electric shock.
 - Avoid body contact with earthed or grounded surfaces, such as pipes, radiators, ranges and refrigerators.** There is an increased risk of electric shock if your body is earthed or grounded.
 - Do not expose power tools to rain or wet conditions.** Water entering a power tool will increase the risk of electric shock.
 - Do not abuse the cord. Never use the cord for carrying, pulling or unplugging the power tool. Keep cord away from heat, oil, sharp edges or moving parts.** Damaged or entangled cords increase the risk of electric shock.
 - When operating a power tool outdoors, use an extension cord suitable for outdoor use.** Use of a cord suitable for outdoor use reduces the risk of electric shock.
 - If operating a power tool in a damp location is unavoidable, use a residual current device (RCD) protected supply.** Use of an RCD reduces the risk of electric shock.
- Personal safety**
 - Stay alert, watch what you are doing and use common sense when operating a power tool. Do not use a power tool while you are tired or under the influence of drugs, alcohol or medication.** A moment of inattention while operating power tools may result in serious personal injury.
 - Use personal protective equipment. Always wear eye protection.** Protective equipment such as dust mask, non-skid safety shoes, hard hat, or hearing protection used for appropriate conditions will reduce personal injuries.
 - Prevent unintentional starting. Ensure the switch is in the off-position before connecting to power source and/or battery pack, picking up or carrying the tool.** Carrying power tools with your finger on the switch or energising power tools that have the switch on invites accidents.

If the supply cord is damaged, it must be replaced by an electrician or a power tool repairer in order to avoid a hazard.

Note: Double insulation does not take the place of normal safety precautions when operating this tool. The insulation system is for added protection against injury resulting from a possible electrical insulation failure within the tool.

Using an Extension Lead

Always use an approved extension lead suitable for the power input of this tool. Before use, inspect the extension lead for signs of damage, wear and ageing. Replace the extension lead if damaged or defective.

When using an extension lead on a reel, always unwind the lead completely. Use of an extension lead not suitable for the power input of the tool or which is damaged or defective may result in a risk of fire and electric shock.

- Remove any adjusting key or wrench before turning the power tool on.** A wrench or a key left attached to a rotating part of the power tool may result in personal injury.
 - Do not overreach. Keep proper footing and balance at all times.** This enables better control of the power tool in unexpected situations.
 - Dress properly. Do not wear loose clothing or jewellery. Keep your hair, clothing and gloves away from moving parts.** Loose clothes, jewellery or long hair can be caught in moving parts.
 - If devices are provided for the connection of dust extraction and collection facilities, ensure these are connected and properly used.** Use of dust collection can reduce dust-related hazards.
- Power tool use and care**
 - Do not force the power tool. Use the correct power tool for your application.** The correct power tool will do the job better and safer at the rate for which it was designed.
 - Do not use the power tool if the switch does not turn it on and off.** Any power tool that cannot be controlled with the switch is dangerous and must be repaired.
 - Disconnect the plug from the power source and/or the battery pack from the power tool before making any adjustments, changing accessories, or storing power tools.** Such preventive safety measures reduce the risk of starting the power tool accidentally.
 - Store idle power tools out of the reach of children and do not allow persons unfamiliar with the power tool or these instructions to operate the power tool.** Power tools are dangerous in the hands of untrained users.
 - Maintain power tools. Check for misalignment or binding of moving parts, breakage of parts and any other condition that may affect the power tool's operation. If damaged, have the power tool repaired before use.** Many accidents are caused by poorly maintained power tools.
 - Keep cutting tools sharp and clean.** Properly maintained cutting tools with sharp cutting edges are less likely to bind and are easier to control.
 - Use the power tool, accessories and tool bits etc. in accordance with these instructions, taking into account the working conditions and the work to be performed.** Use of the power tool for operations different from those intended could result in a hazardous situation.
 - Service**
 - Have your power tool serviced by a qualified repair person using only identical replacement parts.** This will ensure that the safety of the power tool is maintained.

MULTIPURPOSE SAW SAFETY WARNINGS

WARNING! Hold power tool by insulated gripping surfaces, when performing an operation where the cutting accessory may contact hidden wiring or its own cord. Cutting accessory contacting a "live" wire may make exposed metal parts of the power tool "live" and could give the operator an electric shock.

- **Wear a hard hat, safety glasses and/or face shield.** It is also highly recommended that you wear a dust mask, ear protection and padded gloves.
- **Check the blade carefully for cracks or damage** prior to operation. Replace cracked or damaged blades immediately.
- **Hold the tool firmly during operation.**
- **Ensure no one is below you** when using the tool in elevated conditions.
- **Do not point the tool at anyone** in the immediate vicinity.
- **If the blade hits against objects during operation,** damage to the tool or dangerous blade breakage may occur.
- **Watch out for cut-off portions** of the workpiece being cut. They may fall and cause injury to or someone near you.
- **When cutting metals, be cautious of hot, flying debris.**
- **Do not touch the blade or workpiece immediately after operation;** they may be extremely hot and could potentially burn your skin.

• **Always switch off the tool** and wait until the blade has come to a complete stop before withdrawing the blade from the work piece. This will prevent the blade from snapping which could cause you to lose your grip and/or control of the saw.

WARNING! When making a "blind" cut (you can't see behind what is being cut), be sure that hidden electrical wiring or water pipes are not in the path of the cut. If wires are present, they must be disconnected at their power source by a qualified person or avoided to prevent the possibility of lethal shock or fire.

ozito

MULTI PURPOSE SAW

500W

ORIGINAL INSTRUCTIONS

SPECIFICATIONS

Input:	500W
Voltage:	230-240V ~ 50Hz
No Load Speed:	500-3000 /min
Stroke Length:	12mm
Blade Fitment:	Universal
Cutting Capacity:	Timber 100mm Aluminium 6mm Mild Steel 3mm
Weight:	2.5kg

ozito-diy.co.uk

3 YEAR REPLACEMENT WARRANTY

WHAT'S IN THE BOX



Multi-purpose Saw

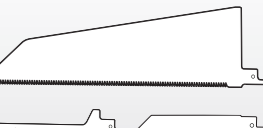

Blades x 3



Hex Key



Spare Brushes

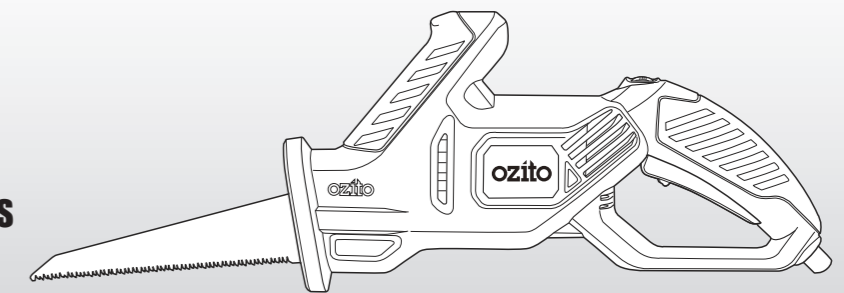

MSW-3000U

WARRANTY

All of our products undergo strict quality checks to ensure that they reach you in perfect condition. In the unlikely event that your device develops a fault, please contact our service department at the address shown on this guarantee card. You can also contact us by telephone using the customer service number shown. Please note the following terms under which guarantee claims can be made:

1. These warranty terms regulate additional warranty services, which the manufacturer mentioned below promises to buyers of its new products in addition to their statutory guarantee claims are not affected by this guarantee. Our guarantee is free of charge to you.

2. The warranty services only covers defects due to material or manufacturing faults on a product which you have bought from the manufacturer mentioned below are limited to either the rectification of said defects on the product or the replacement of the product, whichever we prefer. Please note that our devices are not designed for use in commercial, trade or professional applications. A guarantee contract will not be created if the device has been used by commercial, trade or industrial business or has been exposed to similar stresses during the guarantee period.

3. The following are not covered by our guarantee:

- Damage to the device caused by a failure to follow the assembly instructions or due to incorrect installation, a failure to follow the operating instructions (for example connecting it to an incorrect mains voltage or current type) or a failure to follow the maintenance and safety instructions or by exposing the device to abnormal environmental conditions or by lack of care and maintenance.
- Damage to the device caused by abuse or incorrect use (for example overloading the device or the use or unapproved tools or accessories), ingress of foreign bodies into the device (such as sand, stones or dust, transport damage), the use of force or damage caused by external forces (for example by dropping it).

- Damage to the device or parts of the device caused by normal or natural wear or tear or by normal use of the device.

4. Your Product is guaranteed for a period of 36 months from the original date of purchase and is intended for DIY (Do It Yourself) use only. Lithium Ion batteries and chargers are covered by a 12 month warranty. Warranty excludes consumable parts. Guarantee claims should be submitted before the end of the guarantee period within two weeks of the defect being noticed. No guarantee claims will be accepted after the end of the guarantee period. The original guarantee period remains applicable to the device even if repairs are carried out or parts are replaced. In such cases, the work performed or parts fitted will not result in an extension of the guarantee period, and no new guarantee will become active for the work performed or parts fitted. This also applies if an on-site service is used.

IN ORDER TO MAKE A CLAIM UNDER THIS WARRANTY YOU MUST RETURN THE PRODUCT TO THE PLACE OF PURCHASE WITH YOUR REGISTER RECEIPT.

Please refer to the restrictions of this warranty concerning wearing parts, consumables and missing parts as set out in the service information in these operating instructions.

CUSTOMER SERVICE HELPLINE
GB: 0151 294 4488
IRL: 1850 882711
Ozito-diy.co.uk

KNOW YOUR PRODUCT

MULTIPURPOSE SAW

- 1 Universal Blade
- 2 Front Handle
- 3 Variable Speed Dial
- 4 Safety Lock-off Switch
- 5 On/off Trigger
- 6 Rear Handle with Sure Grip

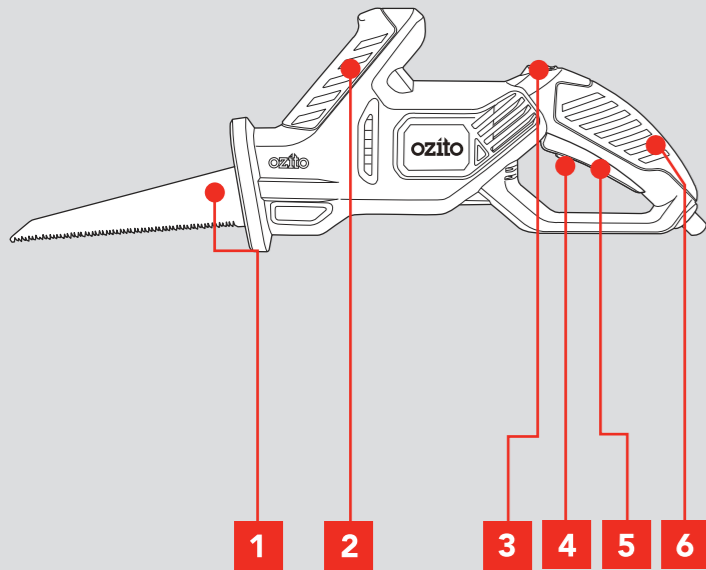

ACCESSORIES

- 7 Spare Brushes
- 8 Hex Key
- 9 Metal Blade
- 10 Scrolling Blade
- 11 General Purpose Blade

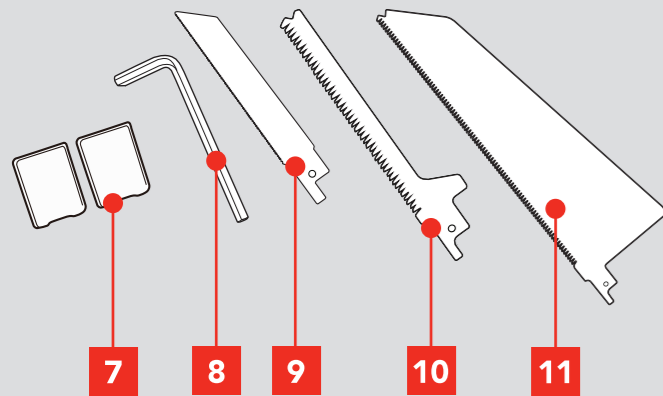

ONLINE MANUAL

Scan this QR Code with your mobile device to take you to the online manual.



SETUP & PREPARATION

1. FITTING BLADES

Before you make any adjustments, make sure the power cord is disconnected from the electricity supply.

1. Insert the hex key into the blade locking screw. Turn anti-clockwise to loosen the screw but do not remove it completely.

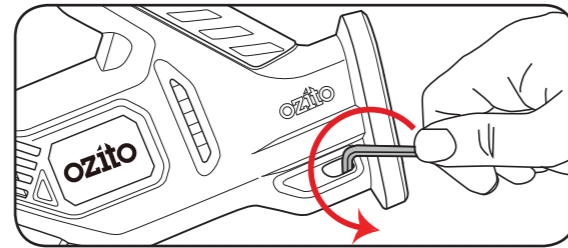

2. Insert the blade. Locate the hole in the blade over the retaining pin and between the clamping plate and holder shaft.

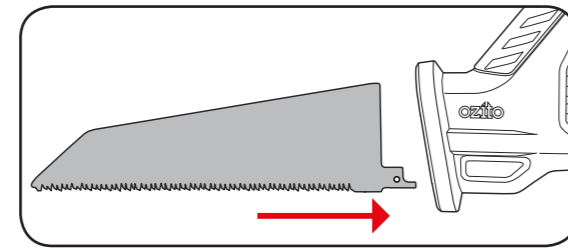

3. Tighten the blade locking screw with the hex key.

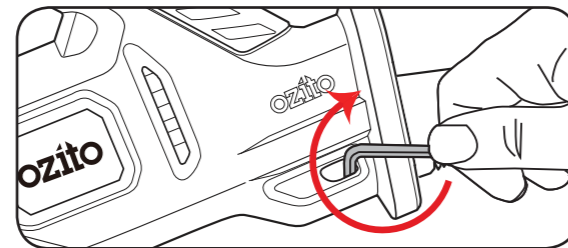

Note: Periodically check that the blade is properly secured.

OPERATION

2. CONTROLS

The tool is recommended for use with a residual current device with a rated residual current of 30mA or less.

On/Off Switch

1. Pull the safety lock-off switch down and hold.

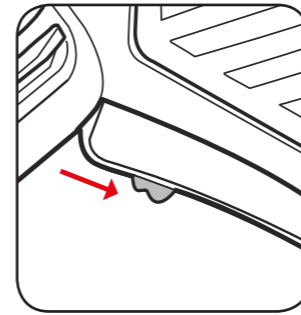

2. Squeeze the on/off trigger.

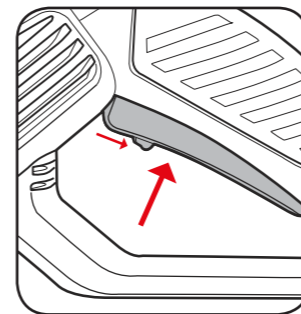

3. To turn off, release the on/off trigger.

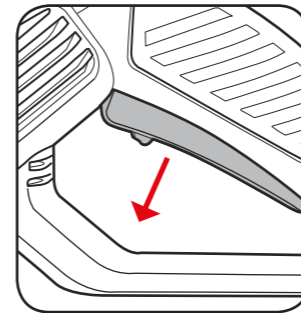

Variable Speed Dial

1. Scroll through the variable speed dial to select the appropriate speed for the material being cut.

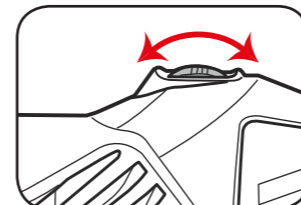

3. OPERATING THE MULTIPURPOSE SAW

1. Securely clamp the workpiece.

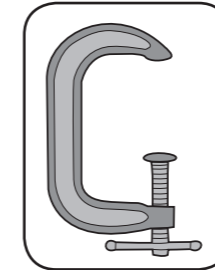

2. Turn the multipurpose saw on and wait for it to reach full speed.

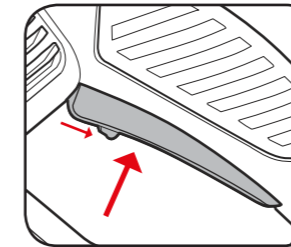

3. Apply the saw to the workpiece, guide the blade back and forth in a sawing motion to complete the cut.

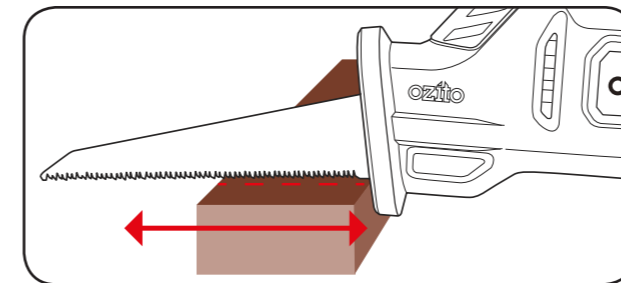

NOTE: ONLY SUPPLY SUFFICIENT PRESSURE TO ALLOW THE BLADE TO DO THE CUTTING. DO NOT FORCE THE OPERATION. BLADES COULD BE DAMAGED IF EXCESSIVE PRESSURE IS APPLIED.