

**PARKSIDE**

**PASS 3.6 A1**



GB IE

**POWER SCREWDRIVER**

Operation and Safety Notes  
Original operating instructions

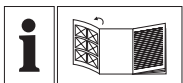

GB IE

Before reading, unfold the page containing the illustrations and familiarise yourself with all functions of the device.

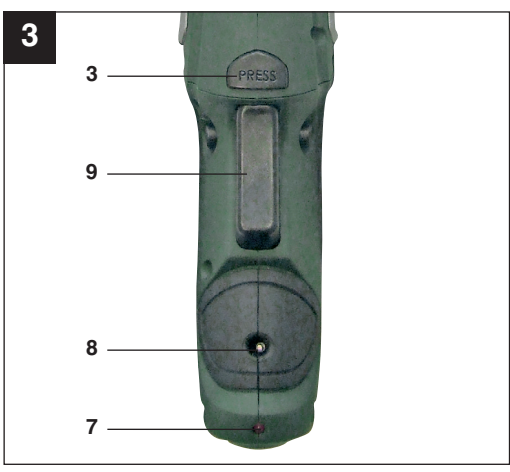

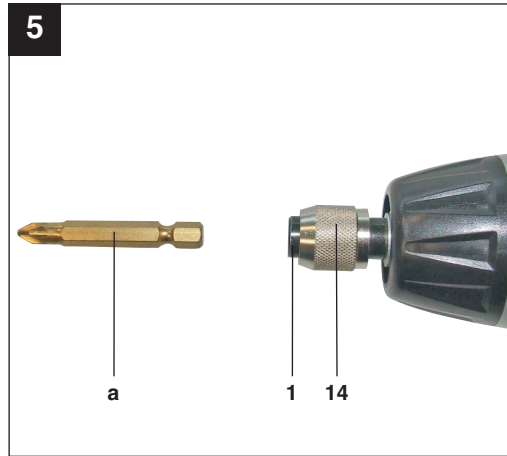
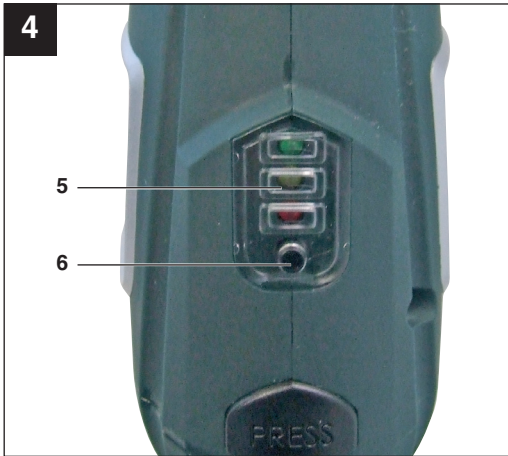

<b>Table of contents:</b>	<b>Page</b>
1. Introduction .....	7
2. Safety regulations .....	7-11
3. Layout .....	11
4. Items supplied.....	11
5. Intended use .....	12
6. Technical data .....	12-13
7. Before starting the equipment.....	13
8. Operation .....	13-14
9. Cleaning, maintenance and ordering of spare parts .....	15
10. Disposal and recycling.....	15
11. Declaration of conformity .....	16
12. Guarantee Certificate .....	17

The reprinting or reproduction by any other means, in whole or in part, of documentation and papers accompanying products is permitted only with the express consent of ISC GmbH.

Technical changes subject to change



“Caution - Read the operating instructions to reduce the risk of injury”

## 1. Introduction

### ⚠ Important!

When using equipment, a few safety precautions must be observed to avoid injuries and damage. Please read the complete operating manual with due care. Keep this manual in a safe place, so that the information is available at all times. If you give the equipment to any other person, give them these operating instructions as well. We accept no liability for damage or accidents which arise due to non-observance of these instructions and the safety information.

## 2. Safety regulations

### General safety instructions for electric tools

#### ⚠ CAUTION!

**Read all safety regulations and instructions.**

Any errors made in following the safety regulations and instructions may result in an electric shock, fire and/or serious injury.

**Keep all safety regulations and instructions in a safe place for future use.**

The term "electric tool" used in the safety regulations refers to electric tools operated from the mains power supply (with a power cable) and to battery operated electric tools (without a power cable).

### 1. Workplace safety

- **Keep your work area clean and well illuminated.** Untidy or unlit work areas can result in accidents.
- **Do not use this tool in a potentially explosive environment containing combustible liquids, gases or dust.** Electric tools generate sparks, which can in turn ignite dust or vapors.
- **Keep children and other persons away from the electric tool while it is being used.** Allowing yourself to get distracted can

cause you to lose control of the tool.

## 2. ELECTRICAL SAFETY

- **The tool's connector plug must be able to fit into the socket outlet. Do not modify the plug in any way! Do not use adapter plugs in conjunction with electrically grounded tools.** Unmodified plugs and matching socket outlets reduce the risk of an electric shock.
- **Avoid touching grounded surfaces, such as those of pipes/tubes, heaters, cookers and refrigerators.** There is an increased risk of getting an electric shock if you are electrically grounded.
- **Keep the tool away from rain and moisture/wet conditions.** Penetration of water into an electric tool increases the risk of an electric shock.
- **Do not use the cable to carry the tool, hang it up or pull the plug out of the socket. Keep the cable away from sources of heat, oil, sharp edges and moving tool parts.** Damaged or tangled cable increases the risk of an electric shock.
- **If you intend to use an electric tool outdoors, ensure that you only use extension cable that is approved for outdoor applications.** Using extension cable that is approved for outdoor applications reduces the risk of an electric shock.
- **If operation of the electric tool in a damp environment can not be avoided, use a earth-leakage circuit-breaker.** The earth-leakage circuit-breaker reduces the risk of an electric shock.

## 3. PERSONAL SAFETY

- **Be alert, work conscientiously and exercise appropriate caution when using the electric tool. Do not use the tool if you are tired or are under the influence of drugs/medication or alcohol.** One moment of carelessness or lack of attention when using the electric tool can cause serious bodily injury!
- **Always wear personal protective**

GB/  
IE**equipment (PPE), including safety goggles.**

Wearing personal protective equipment such as a dust mask, non-slip footwear, protective headgear and ear muffs (depending upon the type of electric tool and the particular application) reduces the risk of sustaining injury.

- **Make sure that the tool cannot start up accidentally. Ensure that the electric tool is switched off before you connect the tool to the power supply and/or insert the battery, or pick up or carry the tool.**

Physically touching the switch with your finger when carrying the tool or connecting the tool to the power supply switched on can lead to accidents.

- **Remove adjusting tools/wrench(es) prior to switching on the power tool.**

A tool or wrench that is positioned inside a rotating power tool part can cause injury.

- **Avoid abnormal working postures. Make sure you stand squarely and keep your balance at all times.**

This way, you will be able to have better control over the tool in unexpected situations.

- **Wear suitable clothes. Never wear loose fitting clothes or jewelry. Keep hair, clothes and gloves away from moving parts.**

Loose clothing, dangling jewelry and long hair can be caught by moving parts.

- **If dust extraction and dust collection devices can be mounted, ensure that these are connected and are properly used.**

The use of a dust extraction system can reduce the danger posed by dust.

**4. Using the treatment of electric tools**

- **Do not overload your tool. Only use suitable electric tools to perform your work.**

Using the right electric tool allows you to work better and safer within the tool's quoted capacity range.

- **Do not use an electric tool whose switch is defective.**

An electric tool that no longer can be switched on or off is dangerous and must be repaired.

- **Pull the plug out of the socket and/or remove the battery before making any adjustments to the tool, changing accessories or put the tool down.**

This precaution eliminates the possibility of inadvertently starting the tool.

- **When not in use, store electric tools out of the reach of children. Do not allow those persons to use this tool who are unfamiliar with it or who have not read these instructions.**

Electric tools are dangerous when they are used by inexperienced persons.

- **Take good care of your tool. Check that moving parts properly function and do not jam, that parts are not broken off or damaged in any way and that the tool can be used to its full capacity. Have damaged parts repaired prior to using the tool.**

The cause of many accidents can be traced back to poorly maintained electric tools.

- **Keep your blades sharp and clean.** Properly maintained blades with sharp edges jam less frequently and are easier to use.

- **Make sure to use electric tools, accessories, attachments, etc. in accordance with these instructions. Take the conditions in your work area and the job in hand into account.**

Using electric tools for applications other than those intended can lead to dangerous situations.

**5. Usage and treatment of battery powered electric tools**

- **Only charge the batteries in chargers that are recommended by the manufacturer.** A charger that is designed for a certain type of batteries may pose a fire risk if it is used with other types of batteries.

- **Use only the correct batteries in the electric tools.** The use of other batteries may result in injuries and a fire risk.

- **Keep unused batteries away from paper**



**clips, coins, keys, nails, screws and other metallic objects that could cause a short circuit between the contacts.** A short circuit between the battery contacts may cause burns or a fire.

- **In case of incorrect use, fluid may escape from the battery. Avoid contact with it. If you touch it by mistake, rinse the affected area with water. If you get the fluid in your eyes, also seek medical advice.** Leaking battery fluid can cause skin irritation or burns.

## 6. SERVICE

- **Have your tool repaired only by authorized specialists using original replacement parts.**

This will ensure that your tool remains safe to use.

**Hold the equipment by the insulated handles when carrying out work during which the screw or the plug-in tool could strike concealed power cables.** Contact with a live cable may also make the metal parts of the equipment live and cause an electric shock.

### Additional safety instructions

We pay a great deal of attention to the design of every battery pack to ensure that we supply you with batteries which feature maximum power density, durability and safety. The battery cells have a wide range of safety devices. Each individual cell is initially formatted and its electrical characteristic curves are recorded. These data are then used exclusively to be able to assemble the best possible battery packs. **Despite all the safety precautions, caution must always be exercised when handling batteries. The following points must be obeyed at all times to ensure safe use.**

**Safe use can only be guaranteed if undamaged cells are used. Incorrect handling can cause cell damage.**

**Important:** Analyses confirm that incorrect use and poor care are the main causes of the damage caused by high performance batteries.

### Information about the battery

- The battery pack supplied with your cordless tool is not charged. The battery pack has to be charged before you use the tool for the first time.
- For optimum battery performance avoid low discharge cycles. Charge the battery pack frequently.
- Store the battery pack in a cool place, ideally at 15°C and charged to at least 40%.
- Lithium-ion batteries are subject to a natural ageing process. The battery pack must be replaced at the latest when its capacity falls to just 80% of its capacity when new. Weakened cells in an aged battery pack are no longer capable of meeting the high power requirements and therefore pose a safety risk.
- Do not throw battery packs into an open fire. There is a risk of explosion!
- Do not ignite the battery pack or expose it to fire.
- **Do not exhaustively discharge batteries.** Exhaustive discharge will damage the battery cells. The most common cause of exhaustive discharge is lengthy storage or non-use of partly discharged batteries. Stop working as soon as the performance of the battery falls noticeably or the electronic protection system triggers. Place the battery pack in storage only after it has been fully charged.
- **Protect batteries and the tool from overloads.** Overloads will quickly result in overheating and cell damage inside the battery housing without this overheating actually being apparent externally.
- **Avoid damage and shocks.** Replace batteries which have been dropped from a height of more than one meter or which have been exposed to violent shocks without delay, even if the housing of the battery pack appears to be undamaged. The battery cells inside the battery may have suffered serious damage. In this respect,

GB/  
IE

please also read the waste disposal information.

- If the battery pack suffers overloading and overheating, the integrated protective cut-off will switch off the equipment for safety reasons. **Important.** Do not press the ON/OFF switch any more if the protective cut-off has actuated. This may damage the battery pack.
- Use only original battery packs. The use of other batteries may result in injuries, explosion and a fire risk.

### Information on chargers and the charging process

- Please check the data marked on the rating plate of the battery charger. Be sure to connect the battery charger to a power supply with the voltage marked on the rating plate. Never connect it to a different mains voltage.
- Protect the battery charger and its cable from damage and sharp edges. Have damaged cables repaired without delay by a qualified electrician.
- This battery charger is not designed to be used by people (including children) with limited physical, sensory or mental capacities or those with no experience and/or knowledge unless they are supervised by a person who is responsible for their safety or they have received instructions from such a person in how to use the equipment safely.
- Children must always be supervised in order to ensure that they do not play with the equipment.
- Do not use damaged battery chargers.
- Do not use the supplied battery charger to charge other cordless tools.
- In heavy use the battery pack will become warm. Allow the battery pack to cool to room temperature before commencing with the charging.
- **Do not over-charge batteries.** Do not exceed the maximum charging times. These charging times only apply to discharged batteries. Frequent insertion of a charged or partly charged battery pack will result in over-charging and cell damage. Do

not leave batteries in the charger for days on end.

- **Never use or charge batteries if you suspect that the last time they were charged was more than 12 months previously.** There is a high probability that the battery pack has already suffered dangerous damage (exhaustive discharge).
- Charging batteries at a temperature below 10°C will cause chemical damage to the cell and may cause a fire.
- Do not use batteries which have heated during the charging process, as the battery cells may have suffered dangerous damage.
- Do not use batteries which have suffered curvature or deformation during the charging process or which show other non-typical symptoms (gassing, hissing, cracking,...)
- Never fully discharge the battery pack (recommended depth of discharge max. 80%) A complete discharge of the battery pack will lead to premature ageing of the battery cells.
- Never charge the batteries unsupervised.

### Protection from environmental influences

- Wear suitable work clothes. Wear safety goggles.
- **Protect your cordless tool and the battery charger from moisture and rain.** Moisture and rain can cause dangerous cell damage.
- Do not use the cordless tool or the battery charger near vapors and inflammable liquids.
- Use the battery charger and cordless tools only in dry conditions and an ambient temperature of 10-40°C.
- Do not keep the battery charger in places where the temperature is liable to reach over 40°C. In particular, do not leave the battery charger in a car that is parked in the sunshine.
- **Protect batteries from overheating.** Overloads, over-charging and exposure to direct sunlight will result in overheating and cell damage. Never charge or work with batteries which have been overheated –

replace them immediately if possible.

- **Storage of batteries, battery chargers and cordless tools.** Store the charger and your cordless tool only in dry places with an ambient temperature of 10-40°C. Store your lithium-ion battery pack in a cool, dry place at a temperature of 10-20°C. Protect them from humidity and direct sunlight. Only place fully charged batteries in storage (charged at least 40%).
- Prevent the lithium-ion battery pack from freezing. Battery packs which were stored below 0°C for more than 60 minutes must be disposed of.
- When handling batteries beware of electrostatic charge: Electrostatic discharges cause damage of the electronic protection system and the battery cells. Avoid electrostatic charging and never touch the battery poles.

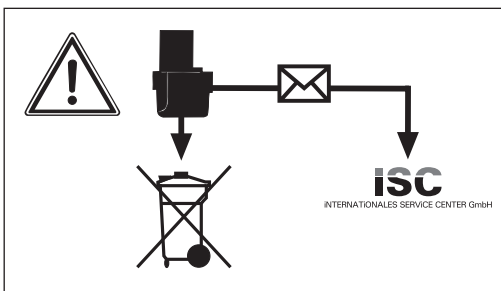

Rechargeable batteries and cordless electric machines and tools contain materials that are potentially harmful to the environment. Never place any cordless electric machines or tools in your household refuse. When cordless electric machines or tools become defective or worn, remove the rechargeable batteries and return them to iSC GmbH (address: Eschenstrasse 6, D-94405, Germany). If the rechargeable batteries cannot be removed, return the complete cordless machine or tool. You can then be sure that the equipment will be correctly disposed of by the manufacturer.

**When shipping or disposing of batteries and cordless tools, always ensure that they are packed individually in plastic bags to prevent short circuits and fires.**

**Do not lose this safety information.**

### 3. Layout (Fig. 1)

1. Bit chuck
2. LED lamp
3. Locking button
4. ON/OFF switch for lamp
5. Battery capacity indicator
6. Button for battery capacity indicator
7. Charging control lamp
8. Charging connection
9. ON/OFF switch
10. Clockwise/Counter-clockwise selector switch
11. Battery charger
12. Charging cable
13. Torque selector
14. Locking sleeve

### 4. Items supplied

Take all parts out of the packaging and check that they are complete.

- Cordless Screwdriver PASS 3.6 A1
- Battery charger
- 26 Bits
- Bit holder
- Case
- Operating Instructions

GB/  
IE

## 5. Intended use

The cordless screwdriver is designed for tightening and loosening screws.

The equipment is to be used only for its prescribed purpose. Any other use is deemed to be a case of misuse. The user/operator and not the manufacturer will be liable for any damage or injuries caused as a result thereof.

Please note that our equipment has not been designed for use in commercial, trade or industrial applications. Our warranty will be voided if the equipment is used in commercial, trade or industrial businesses or for equivalent purposes.

## 6. Technical data

Motor power supply:	3.6 V DC
Idling speed:	200 rpm
Clockwise/Counter-clockwise:	Yes
Battery charger output voltage:	6,8 V DC
Battery charger output current:	550 mA
Battery charger supply voltage:	230V ~ 50 Hz
Charging time:	3 hours
Battery type:	Li-Ion/1.5 Ah
Weight:	0.4 kg
LED Class	1

## Sound and vibration

Sound and vibration values were measured in accordance with EN 60745.

Sound pressure level $L_{pA}$	62 dB(A)
Uncertainty $K_{pA}$	3 dB
Sound power level $L_{WA}$	73 dB(A)
Uncertainty $K_{WA}$	3 dB

### Wear ear-muffs.

The impact of noise can cause damage to hearing.

Total vibration values (vector sum of three directions) determined in accordance with EN 60745.

### Screws without hammer action

Vibration emission value  $a_h \leq 2.5 \text{ m/s}^2$

Tolerance  $K = 1.5 \text{ m/s}^2$

### Warning!

The specified vibration value was established in accordance with a standardized testing method. It may change according to how the electric equipment is used and may exceed the specified value in exceptional circumstances.

The specified vibration value can be used to compare the equipment with other electric power tools.

The specified vibration value can be used for initial assessment of a harmful effect.

### Keep the noise emissions and vibrations to a minimum.

- Only use appliances which are in perfect working order.
- Service and clean the appliance regularly.
- Adapt your working style to suit the appliance.
- Do not overload the appliance.
- Have the appliance serviced whenever necessary.
- Switch the appliance off when it is not in use.

- Wear protective gloves.

## 7. Before starting the equipment

### ⚠ Caution:

Be sure to read the following information before you use your cordless screwdriver for the first time:

1. Only charge the battery pack using the charger (11) supplied.
2. Only use screwdriver bits which are in perfect working order and appropriate.
3. When screwing into walls or partitions, test these for electrical, gas or water connections.

## 8. Operation

### 8.1 Charging the battery pack (Fig. 1)

The battery pack is protected from exhaustive discharge. An integrated protective circuit automatically switches off the equipment when the battery pack is flat. In this case the bit chuck (1) will cease to turn.

### ⚠ Caution:

Do not press the ON/OFF switch (9) any more, if the protective circuit has actuated. This may damage the battery pack.

1. Check that your mains voltage is the same as that marked on the rating plate of the battery charger. Plug the battery charger (11) in the plug socket and connect the charging cable (12) to the charging connection (8). The charging process starts as soon as the charging cable is connected to the charging connection.
2. The charging control lamp (7) indicates that the battery is being charged.
3. The charging control lamp (7) goes out when charging is completed.

### ⚠ Caution:

The handle may become a little warm during the charging process. This is normal.

If the battery pack fails to charge, please check

- whether there is voltage at the socket-outlet.
- whether there is good contact at the charging contacts of the battery charger (11).

If the battery still fails to charge, send

- the battery charger (11)
- and the screwdriver

to our customer services department.

Timely recharging of the battery pack will help to prolong its lifespan. You must recharge the battery pack when you notice that the power of the screwdriver drops.

### 8.2 Clockwise/Counter-clockwise changeover switch (Fig. 2/Item 10)

The clockwise/counter-clockwise changeover switch (10) above the ON/OFF switch (9) is for setting the direction of rotation of the cordless screwdriver and for preventing the cordless screwdriver from being switched on inadvertently. You can select between clockwise and counter-clockwise rotation.

### ⚠ Important.

Change the direction of rotation only when the equipment is at a standstill. If you fail to observe this point, the gearing may become damaged. When the clockwise/counter-clockwise changeover switch (10) is in the middle position, the ON/OFF switch (9) is blocked.

Direction	Switch position
Clockwise	"R" pressed
Counter-clockwise	"L" pressed

### 8.3 ON/OFF switch (Fig. 2/Item 9)

Press the ON/OFF switch (9) to switch the cordless screwdriver on. Release the ON/OFF switch to switch off the tool.

### 8.4 LED lamp (Fig. 1/Item 2)

The LED lamp (2) can be used in poor lighting conditions to illuminate the area where you want to screw. To switch ON, press the switch (4) and to switch OFF, press the switch (4) again.

GB/  
IE**8.5 Handle adjustment (Fig. 1.2/Item 3)**

The screwdriver can be locked into 2 different angle settings. To do so, press the locking button (3) and move the screwdriver into the desired position. Then release the locking button (3).

**⚠ Caution:**

Before you switch on the screwdriver, make sure that it is correctly locked in the required angle position.

**8.6 Battery capacity indicator (Fig. 4/Item. 5)**

Press the button for the battery capacity indicator (6). The battery capacity indicator (5) indicates the charge state of the battery on 3 coloured LEDs.

**All LEDs are lit:**

The battery is fully charged.

**The yellow and red LED illuminate:**

The battery has an adequate remaining charge.

**Red LED:**

The battery is discharged, it requires charging.

**8.7 Changing the tool (Fig. 5)****⚠ Important.**

Set the clockwise/counter-clockwise changeover switch (10) to its centre position whenever you carry out any work (for example changing the tool, maintenance work, etc.) on the cordless screwdriver.

- Pull back and hold the locking sleeve (14).
- Insert the bit (a) into the bit chuck (1) and let go of the locking sleeve (14)
- Check that it is properly secure by pulling the tool.
- For removal of bits (a), pull back the locking sleeve (14) and hold it firmly.
- Remove the bit (a) and let go of the locking sleeve.

**8.8 Torque Setting (Fig. 1/Item 13)****⚠ Caution:**

Only adjust the torque when the appliance is at a standstill.

The cordless screwdriver is fitted with a mechanical torque selector.

The torque for each particular screw size is adjustable at the torque selector (13). The required torque is dependent upon several factors:

- the type and hardness of the material to be worked with.
- the type and length of the screws used.
- the physical burden placed on the screw connection.

When the torque is reached, this is indicated by the clutch being released.

**8.9 Screws**

It is advisable to use self-centering screws (e.g. Torx, Philips head screws) as these will enable you to work safely and reliably. Always make sure that the bit used is of the same size and shape as the screw.

**8.10 Screwdriver overloaded**

If the screwdriver is overloaded, the automatic safety switch turns the device off. After a few seconds the screwdriver can be used again.

## 9. Cleaning, maintenance and ordering of spare parts

### ⚠ Caution:

Always pull out the mains power plug before starting any cleaning work.

### 9.1 Cleaning

- Keep all safety devices, air vents and the motor housing free of dirt and dust as far as possible. Wipe the appliance with a clean cloth or blast it with compressed air at low pressure.
- We recommend cleaning the appliance immediately after every use.
- Clean the appliance regularly with a damp cloth and some soft soap. Do not use cleaning agents or solvents; these may be aggressive to the plastic parts in the appliance. Ensure that no water can get into the interior of the tool.

### 9.2 Maintenance

There are no other parts inside the equipment which require additional maintenance.

### 9.3 Ordering replacement parts:

Please provide the following information on all orders for spare parts:

- Model/type of the equipment
- Article number of the equipment
- ID number of the appliance

For our latest prices and information please go to [www.isc-gmbh.info](http://www.isc-gmbh.info)

## 10. Disposal and recycling

The equipment is supplied in packaging to prevent it from being damaged in transit. The raw materials in this packaging can be reused or recycled. The appliance and its accessories are made of various types of material, such as metal and plastic. Defective components must be disposed of as special waste. Ask your dealer or your local council.



For EU countries only

Never place any electric tools in your household refuse.

To comply with European Directive 2002/96/EC concerning old electric and electronic equipment and its implementation in national laws, old electric tools have to be separated from other waste and be disposed of in an environment-friendly fashion, e.g. by taking to a recycling depot.

Recycling alternative to returning the electrical equipment:

The owner of the electrical equipment is obligated to arrange for its proper disposal if he no longer wants to keep the equipment in his possession and does not want to return it. In this case the old equipment can be taken to a recycling depot where it is disposed of in accordance with national recycling and waste disposal laws. This does not apply to accessory parts and aids which supplement the old equipment and contain no electrical parts.

GB/  
IE

## 11. Declaration of conformity

Einhell Germany AG · Wiesenweg 22 · D-94405 Landau/Isar



## Konformitätserklärung

- erklärt folgende Konformität gemäß EU-Richtlinie und Normen für Artikel  
 explains the following conformity according to EU directives and norms for the following product  
 déclare la conformité suivante selon la directive CE et les normes concernant l'article  
 dichiara la seguente conformità secondo la direttiva UE e le norme per l'articolo  
 verklaart de volgende overeenstemming conform EU richtlijn en normen voor het product  
 declara la siguiente conformidad a tenor de la directiva y normas de la UE para el artículo  
 declara a seguinte conformidade, de acordo com a directiva CE e normas para o artigo  
 attesterer følgende overensstemmelse i medfør af EU-direktiv samt standarder for artikel  
 förklarar följande överensstämmelse enl. EU-direktiv och standarder för artikeln  
 vakuuttaa, että tuote täyttää EU-direktiivin ja standardien vaatimukset  
 tëendab toote vastavust EL direktiivile ja standarditele  
 vydává následující prohlášení o shodě podle směrnice EU a norem pro výrobek  
 potrjuje sledečo skladnost s smernico EU in standardi za izdelek  
 vydáva nasledujúce prehlásenie o zhode podľa smernice EÚ a noriem pre výrobok  
 a cikkekhez az EU-irányvonal és Normák szerint a következő konformitást jelenti ki  
 deklaruje zgodność wymienionego poniżej artykułu z następującymi normami na podstawie dyrektywy WE.  
 декларира съответното съответствие съгласно Директива на ЕС и норми за артикул  
 paskaidro šādu atbilstību ES direktīvai un standartiem  
 arībūdina šj atitikimā EU reikalavimams ir prekės normoms  
 declară următoarea conformitate conform directivei UE și normelor pentru articolul  
 δηλώνει την ακόλουθη συμμόρφωση σύμφωνα με την Οδηγία ΕΚ και τα πρότυπα για το προϊόν  
 potvrđuje sljedeću usklađenost prema smjernicama EU i normama za artikl  
 Izjava o sukladnosti za ovaj proizvod dostupna je na internet stranici www.lidl.hr.  
 potvrđuje sljedeću usklađenost prema smjernicama EU i normama za artikl  
 potvrđuje sledeću usklađenost prema smernicama EZ i normama za artikal  
 следующим удостоверяется, что следующие продукты соответствуют директивам и нормам ЕС  
 проголошує про зазначену нижче відповідність виробу директивам та стандартам ЄС на виріб  
 Ürünü ile ilgili AB direktifleri ve normları gereğince aşağıda açıklanan uygunluğu belirtir  
 erklærer følgende samsvar i henhold til EU-direktivet og standarder for artikkel  
 Lýsir uppfyllingu EU-reglna og annarra staða vöru

## Akkuschrauber PASS 3.6 A1 / Ladegerät LG PASS 3.6 A1 (Parkside)

- 87/404/EC\_2009/105/EC  
 2005/32/EC\_2009/125/EC  
 2006/95/EC  
 2006/28/EC  
 2004/108/EC  
 2004/22/EC  
 1999/5/EC  
 97/23/EC  
 90/396/EC\_2009/142/EC  
 89/686/EC\_96/58/EC  
 2006/42/EC  
 Annex IV  
 Notified Body:  
 Notified Body No.:  
 Reg. No.:  
 2000/14/EC\_2005/88/EC  
 Annex V  
 Annex VI  
 Noise: measured  $L_{WA}$  = dB (A); guaranteed  $L_{WA}$  = dB (A)  
 P = KW; L/Ø = cm  
 Notified Body:  
 2004/26/EC  
 Emission No.:

Standard references: EN 60745-1; EN 60745-2-2; EN 55014-1;  
EN 55014-2; EN 60335-2-29; EN 60335-1; EN 61000-3-2; EN 61000-3-3

Landau/Isar, den 07.09.2010

  
Weichselgartner/General Manager

  
Unger/Product-Management

First CE: 08  
 Art.-No.: 45.134.26 I.-No.: 11020  
 Subject to change without notice

Archive-File/Record: 4513385-47-4155050-08  
 Documents registrar: Georg Riedel  
 Wiesenweg 22, D-94405 Landau/Isar



# 12. GUARANTEE CERTIFICATE

## Dear Customer,

All of our products undergo strict quality checks to ensure that they reach you in perfect condition. In the unlikely event that your device develops a fault, please contact our service department at the address shown on this guarantee card. Of course, if you would prefer to call us then we are also happy to offer our assistance under the service number printed below. Please note the following terms under which guarantee claims can be made:

1. These guarantee terms cover additional guarantee rights and do not affect your statutory warranty rights. We do not charge you for this guarantee.
2. Our guarantee only covers problems caused by material or manufacturing defects, and it is restricted to the rectification of these defects or replacement of the device. Please note that our devices have not been designed for use in commercial, trade or industrial applications. Consequently, the guarantee is invalidated if the equipment is used in commercial, trade or industrial applications or for other equivalent activities. The following are also excluded from our guarantee: compensation for transport damage, damage caused by failure to comply with the installation/assembly instructions or damage caused by unprofessional installation, failure to comply with the operating instructions (e.g. connection to the wrong mains voltage or current type), misuse or inappropriate use (such as overloading of the device or use of non-approved tools or accessories), failure to comply with the maintenance and safety regulations, ingress of foreign bodies into the device (e.g. sand, stones or dust), effects of force or external influences (e.g. damage caused by the device being dropped) and normal wear resulting from proper operation of the device. This applies in particular to rechargeable batteries for which we nevertheless issue a guarantee period of 12 months.  
  
The guarantee is rendered null and void if any attempt is made to tamper with the device.
3. The guarantee is valid for a period of 3 years starting from the purchase date of the device. Guarantee claims should be submitted before the end of the guarantee period within two weeks of the defect being noticed. No guarantee claims will be accepted after the end of the guarantee period. The original guarantee period remains applicable to the device even if repairs are carried out or parts are replaced. In such cases, the work performed or parts fitted will not result in an extension of the guarantee period, and no new guarantee will become active for the work performed or parts fitted. This also applies when an on-site service is used.
4. In order to assert your guarantee claim, please send your defective device postage-free to the address shown below. Please enclose either the original or a copy of your sales receipt or another dated proof of purchase. Please keep your sales receipt in a safe place, as it is your proof of purchase. It would help us if you could describe the nature of the problem in as much detail as possible. If the defect is covered by our guarantee then your device will either be repaired immediately and returned to you, or we will send you a new device.

Of course, we are also happy offer a chargeable repair service for any defects which are not covered by the scope of this guarantee or for units which are no longer covered. To take advantage of this service, please send the device to our service address.

Einhell UK Ltd  
Morpeth Wharf  
Twelve Quays  
Birkenhead, Wirral  
**CH41 1LF**

Tel. 0151 6491500, Fax 0151 6491501

---

---

---

---

---

---

---

---

---

---

---

---

---

---

---

---

---

---

---

---

---

---

---

---

---

---

---

---

---

---



A series of 25 horizontal lines for writing, spaced evenly down the page.

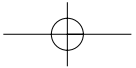
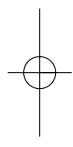
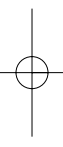



IAN: 61800 PASS 3.6 A1  
**Einhell Germany AG**  
Wiesenweg 22  
D-94405 Landau/Isar

Last Information Update: 10/2010  
Ident.-No.: 45.134.26 102010 - 6

