

ozito

WET & DRY VACUUM WITH POWER TAKE OFF

1400W 25L

INSTRUCTION MANUAL

SPECIFICATIONS

Mains Voltage:	220–240V ~ 50-60Hz
Input Power:	1400W
Max. Suction Power:	180mbar
Air Flow:	32L/s
Air Watts:	200W
Tank Capacity:	25L
Power Outlet Max.:	1000W
Psum:	2400W
Hose Diameter:	35mm
IP Rating:	IPX4
Weight:	7.6kg

ozito.com.au

3 YEAR
REPLACEMENT
WARRANTY*

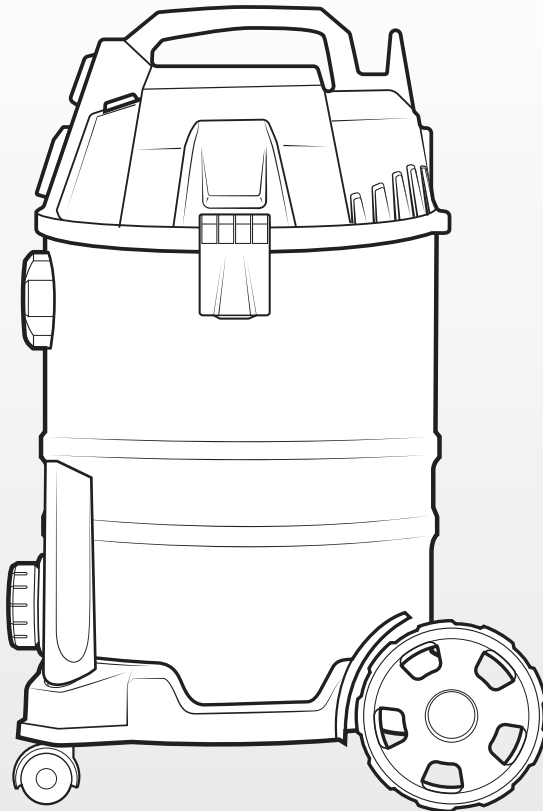

STANDARD EQUIPMENT

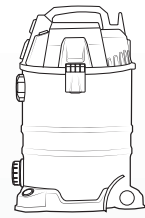

25L Wet & Dry Vacuum

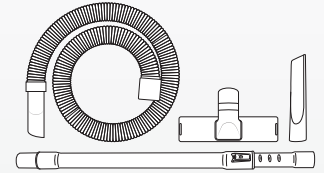

Hose, Floor Tool, Crevice Tool & Telescopic Wand

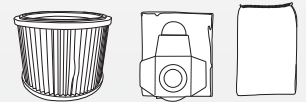

Cartridge Filter, Dust Bag & Foam Filter

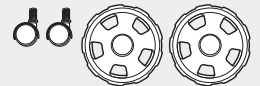

2 x Castor Wheels & 2 x Wheels

VWD-1425PT

WARRANTY

IN ORDER TO MAKE A CLAIM UNDER THIS WARRANTY YOU MUST RETURN THE PRODUCT TO YOUR NEAREST BUNNINGS WAREHOUSE WITH YOUR BUNNINGS REGISTER RECEIPT. PRIOR TO RETURNING YOUR PRODUCT FOR WARRANTY PLEASE TELEPHONE OUR CUSTOMER SERVICE HELPLINE:

Australia: 1800 069 486

New Zealand: 0508 069 486

TO ENSURE A SPEEDY RESPONSE PLEASE HAVE THE MODEL NUMBER AND DATE OF PURCHASE AVAILABLE. A CUSTOMER SERVICE REPRESENTATIVE WILL TAKE YOUR CALL AND ANSWER ANY QUESTIONS YOU MAY HAVE RELATING TO THE WARRANTY POLICY OR PROCEDURE.

The benefits provided under this warranty are in addition to other rights and remedies which are available to you at law.

Our goods come with guarantees that cannot be excluded at law. You are entitled to a replacement or refund for a major failure and for compensation for any other reasonably foreseeable loss or damage. You are also entitled to have the goods repaired or replaced if the goods fail to be of acceptable quality and the failure does not amount to a major failure.

Generally you will be responsible for all costs associated with a claim under this warranty, however, where you have suffered any additional direct loss as a result of a defective product you may be able to claim such expenses by contacting our customer service helpline above.

3 YEAR REPLACEMENT WARRANTY*

Your product is guaranteed for a period of **36 months from the original date of purchase**. If a product is defective it will be replaced in accordance with the terms of this warranty. Warranty excludes consumable parts, for example: valve adapters and accessories.

*This product is intended for DIY use only and replacement warranty covers domestic use.

WARNING

The following actions will result in the warranty being void.

- If the tool has been operated on a supply voltage other than that specified on the tool.
- If the tool shows signs of damage or defects caused by or resulting from abuse, accidents or alterations.
- Failure to perform maintenance as set out within the instruction manual.
- If the tool is disassembled or tampered with in any way.
- Professional, industrial or high frequency use.

KNOW YOUR PRODUCT

WET & DRY VACUUM

- | | |
|-------------------------|----------------------------------|
| 1. Push To Clean Button | 9. Wheel |
| 2. Carry Handle | 10. Crevice Tool |
| 3. Motor | 11. Castor Wheel |
| 4. Cord Hook | 12. Drain Outlet |
| 5. Blower Port | 13. Vacuum Inlet |
| 6. Filter Cage | 14. Power Take Off Socket |
| 7. Motor Securing Clip | 15. On/Off/Power Take Off Switch |
| 8. Stainless Steel Tank | |

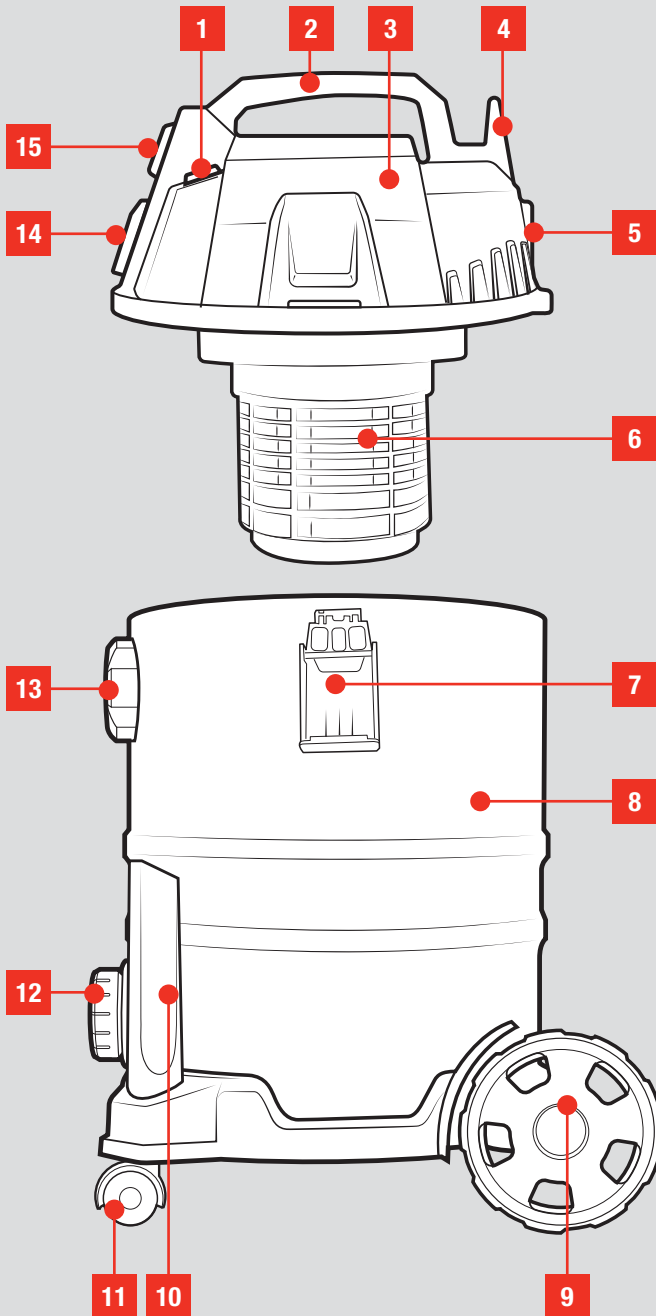

ONLINE MANUAL

Scan this QR Code with your mobile device to take you to the online manual.

3 YEAR REPLACEMENT WARRANTY*



SETUP & PREPARATION

1. ASSEMBLY



WARNING! ENSURE THE TOOL IS TURNED OFF AND DISCONNECTED FROM THE POWER SUPPLY BEFORE PERFORMING ANY OF THE FOLLOWING OPERATIONS.

Attaching The Wheels & Castors

1. Turn the tank upside down and place on a level surface.
2. Press a castor wheel firmly into the slot until it clicks into place.
3. Press the wheels firmly into either side of the frame.

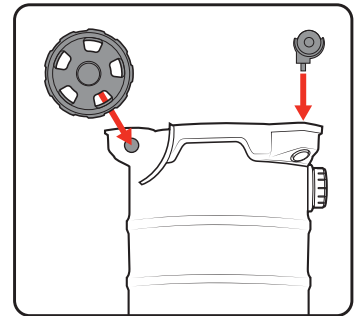

Attaching The Motor Unit

1. Align the sides of the motor unit with the motor securing clips on the tank.

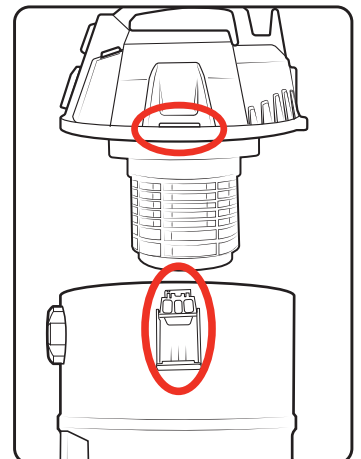

2. Hook the securing clips over the lip of the motor unit and then press lower end of the clips against the sides of the tank to lock them in place.

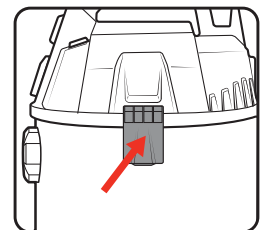

2. FILTER SELECTION



WARNING! NEVER USE THE WET & DRY VACUUM WITHOUT A FILTER. ALWAYS ENSURE THAT THE FILTERS ARE ATTACHED SECURELY.

Wet Vacuuming

Use the **foam filter for wet vacuuming**.

1. Slip the foam filter over the filter cage on the bottom of the motor unit. Ensure that no air can be sucked through the filter cage without being filtered.

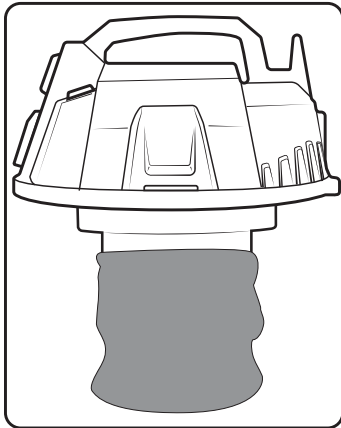

Note: Do not use the pleated filter or dust bag when vacuuming liquids.



WARNING! WHEN WET VACUUMING, SWITCH OFF THE EQUIPMENT IF LIQUID OR FOAM IS EMITTED WITH THE EXHAUST AIR.



WARNING! THE VACUUM IS NOT SUITABLE FOR THE VACUUMING OF COMBUSTIBLE LIQUIDS.



WARNING! ENSURE THE VACUUM IS COMPLETELY DRY BEFORE DRY VACUUMING AGAIN.

Dry Vacuuming

Use the **cartridge filter for dry vacuuming**.

1. Press the open end of the cartridge filter over the filter cage until it is completely covered. No air should be pulled through the unit without being filtered.

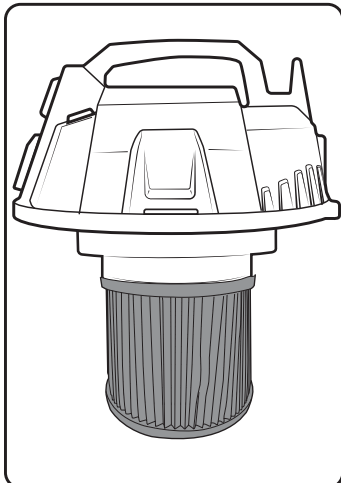

Note: Do not use the foam filter when vacuuming dry matter.

2. To remove the filter, grasp the hard plastic rim of the filter and pull it off the filter cage.

3. WASTE DISPOSAL

Fitting A Dust Bag

For vacuuming fine, dry dirt it is recommended that you fit a dust bag (up to 25L). This will ensure that the filter bag does not clog up as quickly and help maintain the vacuuming power.

A dust bag is suitable for dry vacuuming only. Using the dust bag makes it easier to dispose of collected dust.

1. To attach, slip the dust bag over the vacuum inlet on the inside of the tank.

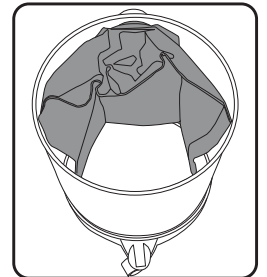

Draining Liquids From The Tank

Spills and puddles can be vacuumed directly into the tank with the addition of the foam filter for easy clean up and disposal.

1. Hold the vacuum over a laundry sink or household drain.

Note: Only dispose of liquid waste into household sinks & drains if safe to do so. Improper disposal of hazardous waste can cause pollution and harm.

2. Turn the drain outlet cap anti-clockwise to loosen and remove it.

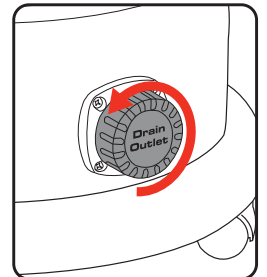

3. Allow any collected liquid in the tank to flow out. Tip the vacuum slightly to allow any liquid at the bottom of the tank to flow out too.

4. Replace the drain outlet cap and rinse out the tank if necessary.

4. ATTACHING ACCESSORIES

Attaching The Hose

Connect the hose to the inlet port on the tank for vacuuming.

Connect the hose to the outlet port on the back of the motor if using the unit as a blower.

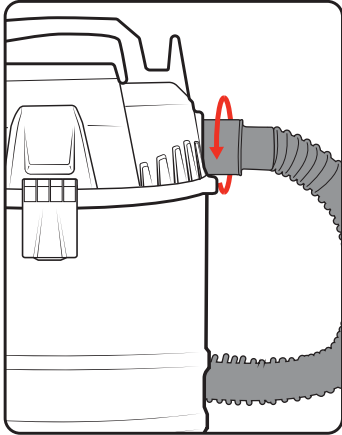

1. Align the tab on the hose with the slot in either of the ports.

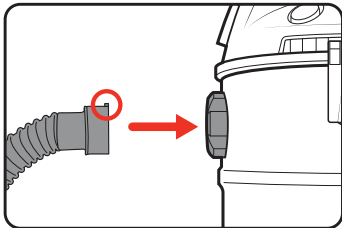

2. Push the hose into the desired port and turn anti-clockwise to lock the hose in place.

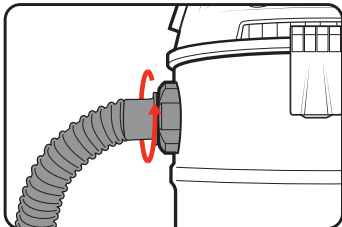

Using The Extension Tubes

The vacuum reach can be increased by attaching the telescopic wand and extending the reach.



Attaching Tools

Use the floor tool to vacuum solids and liquids over medium to large areas.

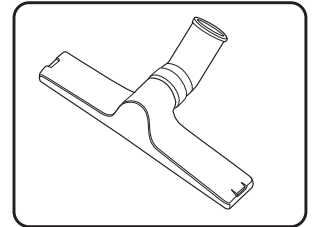

Use the crevice tool to clean tight corners and narrow spaces.

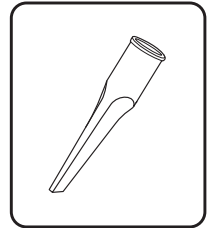

OPERATION

5. CONTROLS

WARNING! TO REDUCE THE RISK OF ELECTRIC SHOCK, A RESIDUAL CURRENT DEVICE (RATED 30mA OR LESS) SHOULD BE USED.

Switching The Vacuum On or Off

1. Rotate the On/Off/Power Take Off Switch to the 'I' position to switch the vacuum on.

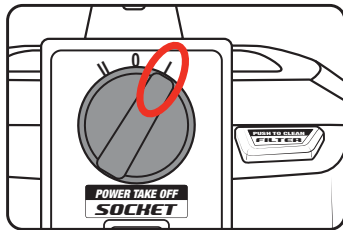

2. Rotate the switch to the centre position to turn the unit off.

WARNING! WHEN WET VACUUMING, THE SAFETY FLOAT STOPS THE VACUUM SUCTION AUTOMATICALLY WHEN THE MAXIMUM CAPACITY IS REACHED. SWITCH OFF THE VACUUM AND EMPTY THE TANK BEFORE CONTINUING TO VACUUM.

WARNING! IF THE VACUUM TIPS OVER DURING USE, THE SAFETY FLOAT WILL ALSO ENGAGE TO PREVENT SPILLAGE. SWITCH THE VACUUM OFF, REST IT VERTICALLY ON THE WHEELS & WAIT FOR THE FLOAT TO RESET BEFORE CONTINUING TO VACUUM.

Note: Moving the vacuum back and forth across certain flooring types can cause a buildup of static on the tank, which may give you a shock when you touch it. An anti static chain has been attached to the tank to prevent this from happening.

Filter Push To Clean Function

The Push To Clean function allows you to clear the filter of fine dust and debris, maintaining maximum suction power during vacuuming.

1. If it is not already, switch the vacuum on.

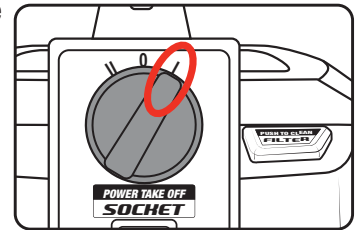

2. Block the vacuum hose inlet by pressing it against a surface.

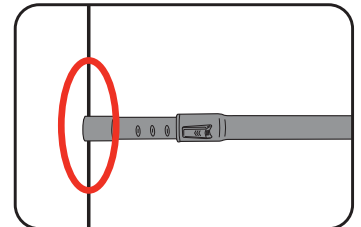

3. Press the filter push to clean button 5 times, holding the button down for about 4 second each time.



4. Continue vacuuming as normal.

Note: If performance does not improve after using the Push To Clean function, empty the drum and check for clogs in the hose or clean the filter manually.

Note: The push to clean function only works when dry vacuuming with the pleated filter. This function does not work with the dust bag or when wet vacuuming with the foam filter.

MAINTENANCE



WARNING! BEFORE CLEANING THE APPLIANCE OR CARRYING OUT ANY MAINTENANCE PROCEDURE, MAKE SURE THAT IT IS DISCONNECTED FROM THE POWER SUPPLY TO PREVENT ACCIDENTAL STARTING.

Power Take Off Mode (Max. Supplied Power: 1000W)

The power take off mode allows you to start the vacuum cleaner automatically by turning the connected power tool on. When you switch off the power tool, the wet and dry vacuum cleaner switches off as well after a preset delay.

1. Connect the power cable on your electric tool to the Power Take Off Socket and connect the suction hose to the extractor connector on your power tool. Check that the connections are secure and airtight.

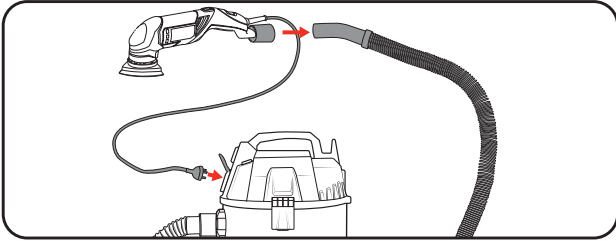

2. Set the switch on the wet and dry vacuum cleaner to the power take off mode (position 'II').

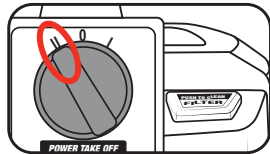

3. Follow normal operating procedures for the connected power tool.

Note: The power take off function requires tools with a power draw of 100W or more to activate. If the tool speed control is set to the lowest setting or the power draw is below 100W, the power take off function may not operate.

Thermal Overload Protection

The power take off outlet is equipped with an automatic thermal overload protector. This feature is designed to prevent permanent damage from occurring to the unit when it overheats during use.



WARNING! DO NOT ATTEMPT TO TURN ON THE CONNECTED POWER TOOL AGAIN IF IT SHUTS OFF AT ANY TIME DURING USE. THE THERMAL OVERLOAD PROTECTOR HAS KICKED IN.

1. Turn the on/off switch to the off position for both the vacuum and connected power tool.
2. Disconnect the vacuum from the power source, then unplug the power tool from the power take off outlet and check the rating label of the power tool.



WARNING! THE POWER TAKE OFF OUTLET HAS A MAXIMUM LIMIT OF 1000W. TOOLS WITH A HIGHER POWER RATING SHOULD NOT BE CONNECTED TO THIS OUTLET.

3. Allow the unit to cool down completely. Approximately 15 minutes (depending on ambient conditions). The thermal overload protector will automatically reset when the tool temperature has dropped within safe operating temperatures.

Cleaning

1. We recommend that you clean the appliance immediately after you use it.
2. Keep the safety devices free of dirt and dust as much as possible. Wipe the equipment with a clean cloth.
3. Clean the appliance regularly with a damp cloth and some soft soap. Do not use cleaning agents or solvents; these may be aggressive to the plastic parts in the appliance. Ensure that no water can get into the interior of the appliance.
4. Clean the tank with a damp cloth and some soft soap or under running water depending on the amount of dirt.
5. Clean the foam filter with a little soft soap under running water and allow it to air dry before use.

Storage

Pull the mains plug out of the socket, switch off the tool and make sure that it is secured in such a way that it cannot be started up again by any unauthorised person.

Wrap the cord neatly around the cord hook for storage. Empty the tank of any dry matter or liquid before storing. Keep the accessories with the unit to avoid losing them.





Store the tool in a dry location which is not accessible to unauthorised persons.

Supply Cords

If replacement of the supply cord is necessary, this has to be done by a certified electrician in order to avoid a safety hazard.

Note: Ozito Industries will not be responsible for any damage or injuries caused by the repair of the tool by an unauthorised person or by mishandling of the tool.

DESCRIPTION OF SYMBOLS

V	Volts	Hz	Hertz
~	Alternating Current	W	Watts
L	Litres	L/s	Litres per second
mbar	Millibar	mm	Millimetres
IPX4	Dust & water protection rating		Warning
	Do not expose to rain		Regulatory Compliance Mark (RCM)
	Read Instruction Manual		

CARING FOR THE ENVIRONMENT



Power tools that are no longer usable should not be disposed of with household waste but in an environmentally friendly way. Please recycle where facilities exist. Check with your local council authority for recycling advice.



Recycling packaging reduces the need for landfill and raw materials. Reuse of recycled material decreases pollution in the environment. Please recycle packaging where facilities exist. Check with your local council authority for recycling advice.

SPARE PARTS

Spare parts can be ordered from the Special Orders Desk at your local Bunnings Warehouse.

For further information, or any parts not listed here, visit

www.ozito.com.au or contact Ozito Customer Service:

Australia 1800 069 486

New Zealand 0508 069 486

E-mail: enquiries@ozito.com.au



ELECTRICAL SAFETY



WARNING! When using mains-powered tools, basic safety precautions, including the following, should always be followed to reduce risk of fire, electric shock, personal injury and material damage. Read the whole manual carefully and make sure you know how to switch the tool off in an emergency, before operating the tool.

Save these instructions and other documents supplied with this tool for future reference.

This tool has been designed for 230V and 240V only. Always check that the power supply corresponds to the voltage on the rating plate.

Note: The supply of 230V and 240V on Ozito tools are interchangeable for Australia and New Zealand.

Using an Extension Lead

Always use an approved extension lead suitable for the power input of this tool. Before use, inspect the extension lead for signs of damage, wear and ageing. Replace the extension lead if damaged or defective.

When using an extension lead on a reel, always unwind the lead completely. Use of an extension lead not suitable for the power input of the tool or which is damaged or defective may result in a risk of fire and electric shock.

The power supply for this product should be protected by a residual current device (rated at 30mA or less). A residual current device reduces the risk of electric shock.



GENERAL POWER TOOL SAFETY WARNINGS



WARNING! Read all safety warnings and all instructions. Failure to follow the warnings and instructions may result in electric shock, fire and/or serious injury.

Save all warnings and instructions for future reference. The term "power tool" in the warnings refers to your mains-operated (corded) power tool or battery-operated (cordless) power tool.

1. Work area safety

- a. **Keep work area clean and well lit.** Cluttered or dark areas invite accidents.
- b. **Do not operate power tools in explosive atmospheres, such as in the presence of flammable liquids, gases or dust.** Power tools create sparks which may ignite the dust or fumes.

2. Electrical safety

- a. **Power tool plugs must match the outlet. Never modify the plug in any way. Do not use any adapter plugs with earthed (grounded) power tools.** Unmodified plugs and matching outlets will reduce risk of electric shock.
- b. **Avoid body contact with earthed or grounded surfaces, such as pipes, radiators, ranges and refrigerators.** There is an increased risk of electric shock if your body is earthed or grounded.
- c. **Do not expose power tools to rain or wet conditions.** Water entering a power tool will increase the risk of electric shock.
- d. **Do not abuse the cord. Never use the cord for carrying, pulling or unplugging the power tool. Keep cord away from heat, oil, sharp edges or moving parts.** Damaged or entangled cords increase the risk of electric shock.
- e. **When operating a power tool outdoors, use an extension cord suitable for outdoor use.** Use of a cord suitable for outdoor use reduces the risk of electric shock.

3. Personal safety

- a. **Stay alert, watch what you are doing and use common sense when operating a power tool. Do not use a power tool while you are tired or under the influence of drugs, alcohol or medication.** A moment of inattention while operating power tools may result in serious personal injury.
- b. **Use personal protective equipment. Always wear eye protection.** Protective equipment such as dust mask, non-skid safety shoes, hard hat, or hearing protection used for appropriate conditions will reduce personal injuries.
- c. **Prevent unintentional starting. Ensure the switch is in the off-position before connecting to power source and/or battery pack, picking up or carrying the tool.** Carrying power tools with your finger on the switch or energising power tools that have the switch on invites accidents.
- d. **Remove any adjusting key or wrench before turning the power tool on.** A wrench or a key left attached to a rotating part of the power tool may result in personal injury.

- e. **Do not overreach. Keep proper footing and balance at all times.** This enables better control of the power tool in unexpected situations.

- f. **Disconnect the power tool from the power source and/or the battery pack from the power tool before making any adjustments, changing accessories, or storing power tools.** Such preventive safety measures reduce the risk of starting the power tool accidentally.

- g. **Do not let familiarity gained from frequent use of tools allow you to become complacent and ignore tool safety principles.** A careless action can cause severe injury within a fraction of a second.

- h. **Do not let familiarity gained from frequent use of tools allow you to become complacent and ignore tool safety principles.** A careless action can cause severe injury within a fraction of a second.

4. Power tool use and care

- a. **Do not force the power tool. Use the correct power tool for your application.** The correct power tool will do the job better and safer at the rate for which it was designed.
- b. **Do not use the power tool if the switch does not turn it on and off.** Any power tool that cannot be controlled with the switch is dangerous and must be repaired.
- c. **Disconnect the plug from the power source and/or the battery pack from the power tool before making any adjustments, changing accessories, or storing power tools.** Such preventive safety measures reduce the risk of starting the power tool accidentally.
- d. **Store idle power tools out of the reach of children and do not allow persons unfamiliar with the power tool or these instructions to operate the power tool.** Power tools are dangerous in the hands of untrained users.
- e. **Maintain power tools.** Check for misalignment or binding of moving parts, breakage of parts and any other condition that may affect the power tool's operation. If damaged, have the power tool repaired before use. Many accidents are caused by poorly maintained power tools.
- f. **Keep cutting tools sharp and clean.** Properly maintained cutting tools with sharp cutting edges are less likely to bind and are easier to control.
- g. **Use the power tool, accessories and tool bits etc. in accordance with these instructions, taking into account the working conditions and the work to be performed.** Use of the power tool for operations different from those intended could result in a hazardous situation.
- h. **Keep handles and grasping surfaces dry, clean and free from oil and grease.** Slippery handles and grasping surfaces do not allow for safe handling and control of the tool in unexpected situations.

5. Service

- a. **Have your power tool serviced by a qualified repair person using only identical replacement parts.** This will ensure that the safety of the power tool is maintained.



VACUUM SAFETY WARNINGS



The appliance is not to be used by persons (including children) with reduced physical, sensory or mental capabilities, or lack of experience and knowledge, unless they have been given supervision or instruction.

Young children should be supervised to ensure that they do not play with the appliance.

WARNING! Before connecting a tool to a power source (mains switch power point receptacle, outlet, etc.) be sure that the voltage supply is the same as that specified on the nameplate of the tool. A power source with a voltage greater than that specified for the tool can result in serious injury to the user, as well as damage to the tool. If in doubt, do not plug in the tool. Using a power source with a voltage less than the nameplate rating is harmful to the motor.

- Do not leave appliance unattended when plugged in. Unplug from outlet when not in use and before servicing and cleaning.
- Always switch the unit off before changing attachments or connecting different power tools.
- Always disconnect equipment from the appliance when it is not in use.
- To avoid electric shock, do not expose to rain. Store indoors.
- Never use in the presence of explosive liquids, vapours or explosive dust – such as coal or grain.
- Never pick up asbestos, asbestos dust or any other hazardous substances.
- Wood dust and chips in a confined area can give rise to fire or an explosion. Guard against possible ignition sources.
- Do not pick up anything that is burning or smouldering – such as metal grinding dust, cigarette ends, hot coals, matches or similar.
- Do not vacuum flammable and combustible liquids such as petrol, oil or other volatile liquids.
- Use only manufacturer's recommended attachments and consumables.
- Never modify the cleaner in any way - this is dangerous and will invalidate the warranty.
- Do not use cleaner without the filter in place.

- If motor sound becomes higher pitched always check for the following:

- Blocked hose or accessory.
- Blocked filter.
- Full container.

- Never try to move the cleaner by pulling with the mains lead.
- Always check that the filter is clear and not blocked. Keep all openings clear of any blockages.
- When lifting the unit, always lift it with the handle or under rim of bucket. Beware of excess weight.
- If the cordset is damaged have it repaired by an authorised service centre.
- The wet and dry vacuum cleaner is designed for wet and dry vacuuming using the appropriate filter. The appliance is not suitable for the vacuuming of combustible, explosive or harmful substances.
- The equipment is to be used only for its prescribed purpose. Any other use is deemed to be a case of misuse. The user / operator and not the manufacturer will be liable for any damage or injuries of any kind caused as a result of this.
- Do not submerge the vacuum in water.
- Do not pick up hot, glowing, burning or cold ash.