

ozito

MULTI FUNCTION TOOL

300W

INSTRUCTION MANUAL

SPECIFICATIONS

Motor:	300W
Input:	230-240V ~ 50Hz
No Load Speed:	15,000-21,000 opm
Orbit Angle:	3.2°
Sanding Pad Size:	90 x 90 x 90mm
Weight:	1.43kg

ozito.com.au

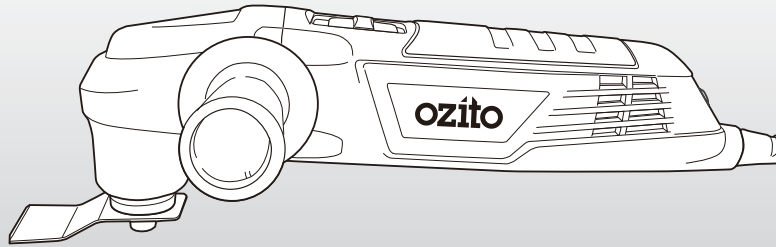

STANDARD EQUIPMENT



Multi Function Tool



Sanding Pad & Paper x 15



Scraper



Triangular Rasp



Straight Blade x 2

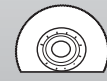

Semi Circular Blade



Grout Removal Disc

3 YEAR REPLACEMENT WARRANTY

MFR-2200

WARRANTY

IN ORDER TO MAKE A CLAIM UNDER THIS WARRANTY YOU MUST RETURN THE PRODUCT TO YOUR NEAREST BUNNINGS WAREHOUSE WITH YOUR BUNNINGS REGISTER RECEIPT. PRIOR TO RETURNING YOUR PRODUCT FOR WARRANTY PLEASE TELEPHONE OUR CUSTOMER SERVICE HELPLINE:

Australia 1800 069 486

New Zealand 0508 069 486

TO ENSURE A SPEEDY RESPONSE PLEASE HAVE THE MODEL NUMBER AND DATE OF PURCHASE AVAILABLE. A CUSTOMER SERVICE REPRESENTATIVE WILL TAKE YOUR CALL AND ANSWER ANY QUESTIONS YOU MAY HAVE RELATING TO THE WARRANTY POLICY OR PROCEDURE.

The benefits provided under this warranty are in addition to other rights and remedies which are available to you at law.

Our goods come with guarantees that cannot be excluded at law. You are entitled to a replacement or refund for a major failure and for compensation for any other reasonably foreseeable loss or damage. You are also entitled to have the goods repaired or replaced if the goods fail to be of acceptable quality and the failure does not amount to a major failure.

Generally you will be responsible for all costs associated with a claim under this warranty, however, where you have suffered any additional direct loss as a result of a defective product you may be able to claim such expenses by contacting our customer service helpline above.

3 YEAR REPLACEMENT WARRANTY

Your product is guaranteed for a period of **36 months from the original date of purchase** and is intended for DIY (Do It Yourself) use only. If a product is defective it will be replaced in accordance with the terms of this warranty. Warranty excludes consumable parts, for example: carbon brushes, blades, sanding paper, etc.

WARNING

The following actions will result in the warranty being void.

- If the tool has been operated on a supply voltage other than that specified on the tool.
- If the tool shows signs of damage or defects caused by or resulting from abuse, accidents or alterations.
- Failure to perform maintenance as set out within the instruction manual.
- If the tool is disassembled or tampered with in any way.
- Professional, industrial or high frequency use.

KNOW YOUR PRODUCT

MULTI FUNCTION TOOL

1. Accessory Drive Spindle
2. Side Handle
3. On/Off Switch
4. Rear Handle
5. Variable Speed Dial

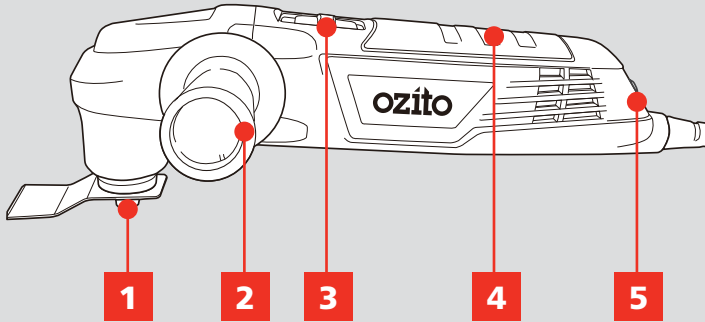

ACCESSORIES

6. Semi Circular Blade (Wood, Plastic & Metal)
7. Straight Blade x 2 (Wood & Plastic)
8. Scraper
9. Triangular Rasp
10. Grout Removal Disc
11. Sanding Pad
12. Sanding Paper (P60 Grit x 5, P120 Grit x 5, P240 Grit x 5)
13. Hex Key
14. Locking Bolt
15. Washer
16. Spring Washer

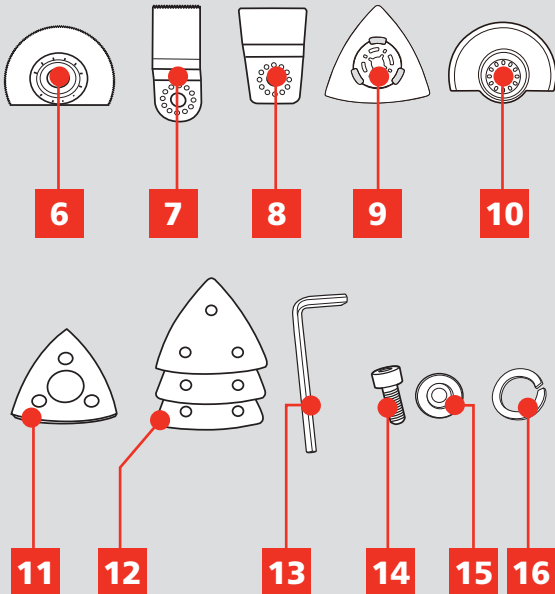

ONLINE MANUAL

Scan this QR Code with your mobile device to take you to the online manual.



SETUP & PREPARATION

1. ASSEMBLY

Accessory Fitment

1. Place accessory over the drive spindle and position to suit angle needed for application.

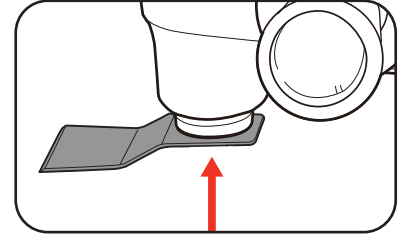

Note: Ensure the accessory is sitting flat on spindle and locking pins.

2. Place flat side of accessory fitting washer on the accessory, then the spring washer and insert the locking bolt.

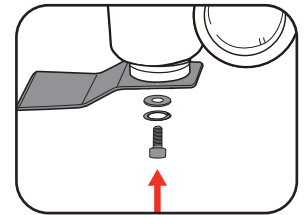

3. Tighten locking bolt with hex key.

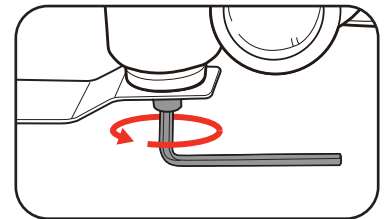

Accessory Removal

1. Loosen locking bolt with hex key.

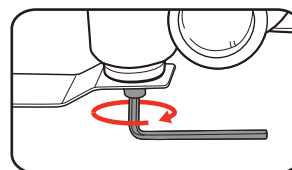

2. Remove bolt and accessory.

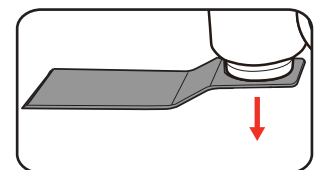

Side Handle

The side handle can be fitted on either side of the tool. The correct position will be determined by your preferred hand and the operation being performed.

Attaching

1. Firmly attach the side handle in the desired position.

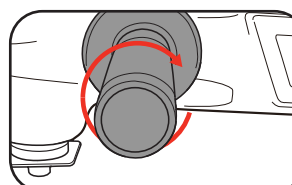

Removing

2. Remove the side handle.

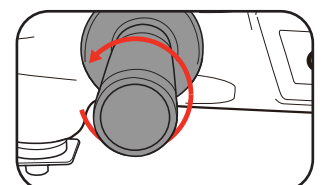

3 YEAR REPLACEMENT WARRANTY

OPERATION

2. CONTROLS



CAUTION: THE POWER SUPPLY FOR THIS PRODUCT SHOULD BE PROTECTED BY A RESIDUAL CURRENT DEVICE (RATED AT 30mA OR LESS).

On / Off Switch

1. To turn on, slide the on/ off switch forward.

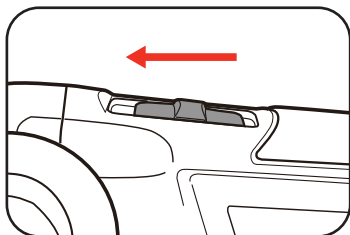

2. To turn off, slide the switch backwards.

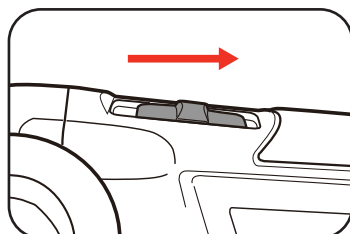

Variable Speed

For various applications, you will need to select the appropriate speed for the task.

1. Turn multi function tool on.

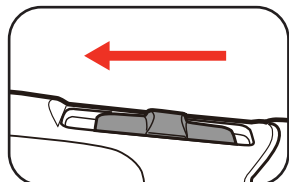

2. Scroll through variable speed dial to desired speed setting.

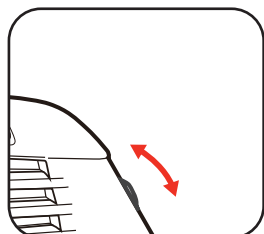

Note: The higher the number on the variable speed dial the faster the oscillation frequency of the multi function tool.

3. SANDING

1. Turn multi function tool on and select appropriate speed.

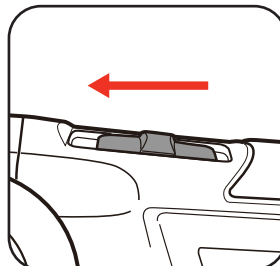

2. Place the multi function tool flat on the workpiece.

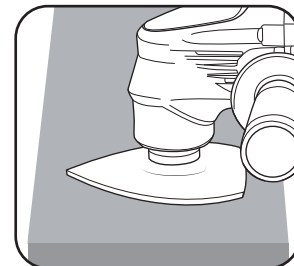

Note: Do not apply heavy pressure to the tool or tilt the sanding base as this will wear out the sanding paper and may damage the sanding pad.

Changing Sanding Paper

1. Align paper to pad and press firmly to attach.
2. Peel paper off pad from one of the corners.

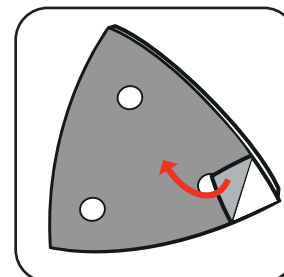
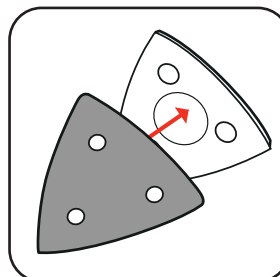

Triangular Rasp

This accessory is suitable when sanding materials which require a large amount of material removal, for example: rough wood, mortar or adhesive cement / concrete.

1. Turn multi function tool on and select appropriate speed.
2. Place the multi function tool flat on the workpiece.

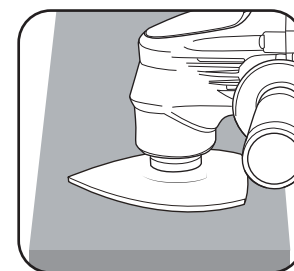
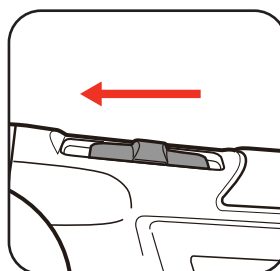

Note: Periodically turn the unit off and remove any built-up dust and debris.

4. SAWING

Note: Ensure blades are not blunt or damaged in any way before commencing application.

Semi Circular & Straight Blade

1. Ensure the workpiece is securely held down.

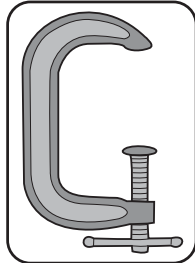

2. Turn multi function tool on and select speed.

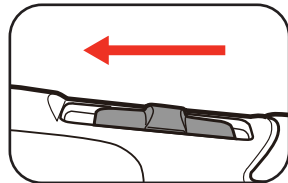

3. Use slight pendulum motion when plunge cutting.

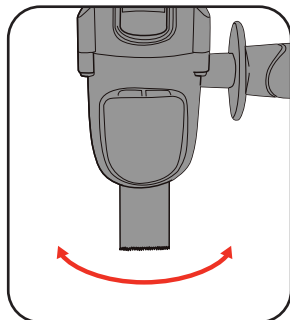

Grout Removal Disc

1. Turn the multi function tool on and select speed.

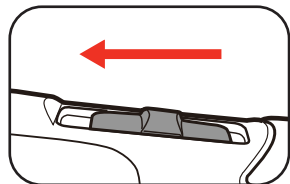

2. Use slight pendulum motion when cutting.

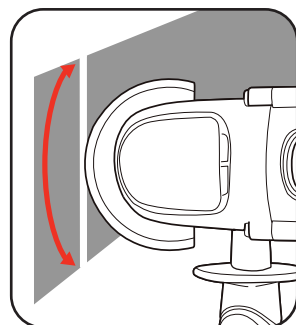

Note: Periodically turn the unit off and remove any built-up dust and debris.

5. SCRAPING

1. Turn multi function tool on and select appropriate speed.

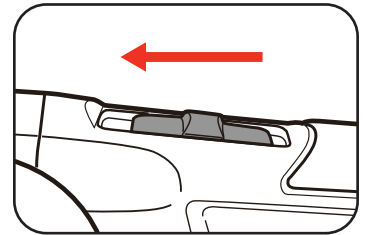

2. Place multi function tool on the workpiece at an angle of approximately 10-15°.

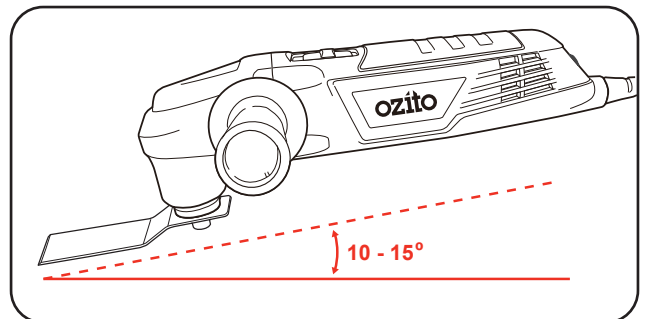

3. Allow the scraper to do the work; do not apply heavy pressure to the multi function tool. This may cause the multi function tool to overload or cut into the surface of the workpiece.

MAINTENANCE



WARNING: BEFORE CARRYING OUT ANY MAINTENANCE PROCEDURES, ENSURE THE TOOL IS SWITCHED OFF AND DISCONNECTED FROM THE POWER SUPPLY.

- Keep the ventilation vents of the multi function tool clean at all times, if possible, prevent foreign matter from entering the vents.
- After each use, blow air through the multi function tool housing to ensure it is free from all dust particles which may build up. Build up of dust particles may cause the tool to overheat and fail.
- If the enclosure of the multi function tool requires cleaning, do not use solvents but a moist soft cloth only. Never let any liquid get inside the multi function tool; never immerse any part of the multi function tool into a liquid.

Carbon Brushes

When the carbon brushes wear out, the multi function tool will spark and/or stop. Discontinue use as soon as this happens. They should be replaced prior to recommencing use of the multi function tool. Carbon brushes are a wearing component of the tool and therefore are not covered under warranty. Continuing to use the multi function tool when carbon brushes need to be replaced may cause permanent damage. Carbon brushes will wear out after many uses but when the carbon brushes need to be replaced, take the multi function tool to an electrician

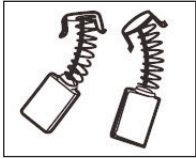

or a power tool repairer for a quick and low cost replacement. Always replace both carbon brushes at the same time.

Note: Ozito Industries will not be responsible for any damage or injuries caused by the repair of the multi function tool by an unauthorised person or by mishandling of the multi function tool.

TROUBLESHOOTING

Sparking visible through the housing air vents

A small amount of sparking may be visible through the housing vents. This is normal and does not indicate a problem.

Excessive sparking visible through the housing air vents and/or the multi function tool failing to operate



May indicate the carbon brushes have worn out and need to be replaced. Carbon brushes should only be replaced by a qualified electrician or power tool repairer.

SPARE PARTS

Spare parts can be ordered from the Special Orders Desk at your local Bunnings Warehouse.

For further information, or any parts not listed here, visit

www.ozito.com.au or contact Ozito Customer Service:

Australia 1800 069 486

New Zealand 0508 069 486

E-mail: enquiries@ozito.com.au

DESCRIPTION OF SYMBOLS

V	Volts	Hz	Hertz
~	Alternating current	W	Watts
/min	Revolutions or reciprocation per minute	n_o	No load speed
	Double insulated		Regulator compliance mark
	Warning		Read instruction manual

CARING FOR THE ENVIRONMENT



Power tools that are no longer usable should not be disposed of with household waste but in an environmentally friendly way. Please recycle where facilities exist. Check with your local council authority for recycling advice.



Recycling packaging reduces the need for landfill and raw materials. Reuse of recycled material decreases pollution in the environment. Please recycle packaging where facilities exist. Check with your local council authority for recycling advice.

ELECTRICAL SAFETY

The electric motor has been designed for 230V and 240V only. Always check that the power supply corresponds to the voltage on the rating plate.

Note: The supply of 230V and 240V on Ozito tools are interchangeable for Australia and New Zealand.



This tool is double insulated therefore no earth wire is required.

If the supply cord is damaged, it must be replaced by an electrician or a power tool repairer in order to avoid a hazard.

Note: Double insulation does not take the place of normal safety precautions when operating this tool. The insulation system is for added protection against injury resulting from a possible electrical insulation failure within the tool.

Using an Extension Lead

Always use an approved extension lead suitable for the power input of this tool. Before use, inspect the extension lead for signs of damage, wear and ageing. Replace the extension lead if damaged or defective.

When using an extension lead on a reel, always unwind the lead completely. Use of an extension lead not suitable for the power input of the tool or which is damaged or defective may result in a risk of fire and electric shock.

GENERAL POWER TOOL SAFETY WARNINGS



WARNING! Read all safety warnings and all instructions. Failure to follow the warnings and instructions may result in electric shock, fire and/or serious injury.

Save all warnings and instructions for future reference. The term "power tool" in the warnings refers to your mains-operated (corded) power tool or battery-operated (cordless) power tool.

1. Work area safety

- Keep work area clean and well lit. Cluttered or dark areas invite accidents.
- Do not operate power tools in explosive atmospheres, such as in the presence of flammable liquids, gases or dust. Power tools create sparks which may ignite the dust or fumes.
- Keep children and bystanders away while operating a power tool. Distractions can cause you to lose control.

2. Electrical safety

- Power tool plugs must match the outlet. Never modify the plug in any way. Do not use any adapter plugs with earthed (grounded) power tools. Unmodified plugs and matching outlets will reduce risk of electric shock.
- Avoid body contact with earthed or grounded surfaces, such as pipes, radiators, ranges and refrigerators. There is an increased risk of electric shock if your body is earthed or grounded.
- Do not expose power tools to rain or wet conditions. Water entering a power tool will increase the risk of electric shock.
- Do not abuse the cord. Never use the cord for carrying, pulling or unplugging the power tool. Keep cord away from heat, oil, sharp edges or moving parts. Damaged or entangled cords increase the risk of electric shock.
- When operating a power tool outdoors, use an extension cord suitable for outdoor use. Use of a cord suitable for outdoor use reduces the risk of electric shock.
- If operating a power tool in a damp location is unavoidable, use a residual current device (RCD) protected supply. Use of an RCD reduces the risk of electric shock.

3. Personal safety

- Stay alert, watch what you are doing and use common sense when operating a power tool. Do not use a power tool while you are tired or under the influence of drugs, alcohol or medication. A moment of inattention while operating power tools may result in serious personal injury.
- Use personal protective equipment. Always wear eye protection. Protective equipment such as dust mask, non-skid safety shoes, hard hat, or hearing protection used for appropriate conditions will reduce personal injuries.
- Prevent unintentional starting. Ensure the switch is in the off-position before connecting to power source and/or battery pack, picking up or carrying the tool. Carrying power tools with your finger on the switch or energising power tools that have the switch on invites accidents.

- Remove any adjusting key or wrench before turning the power tool on. A wrench or a key left attached to a rotating part of the power tool may result in personal injury.
 - Do not overreach. Keep proper footing and balance at all times. This enables better control of the power tool in unexpected situations.
 - Dress properly. Do not wear loose clothing or jewellery. Keep your hair, clothing and gloves away from moving parts. Loose clothes, jewellery or long hair can be caught in moving parts.
 - If devices are provided for the connection of dust extraction and collection facilities, ensure these are connected and properly used. Use of dust collection can reduce dust-related hazards.
- ## 4. Power tool use and care
- Do not force the power tool. Use the correct power tool for your application. The correct power tool will do the job better and safer at the rate for which it was designed.
 - Do not use the power tool if the switch does not turn it on and off. Any power tool that cannot be controlled with the switch is dangerous and must be repaired.
 - Disconnect the plug from the power source and/or the battery pack from the power tool before making any adjustments, changing accessories, or storing power tools. Such preventive safety measures reduce the risk of starting the power tool accidentally.
 - Store idle power tools out of the reach of children and do not allow persons unfamiliar with the power tool or these instructions to operate the power tool. Power tools are dangerous in the hands of untrained users.
 - Maintain power tools. Check for misalignment or binding of moving parts, breakage of parts and any other condition that may affect the power tool's operation. If damaged, have the power tool repaired before use. Many accidents are caused by poorly maintained power tools.
 - Keep cutting tools sharp and clean. Properly maintained cutting tools with sharp cutting edges are less likely to bind and are easier to control.
 - Use the power tool, accessories and tool bits etc. in accordance with these instructions, taking into account the working conditions and the work to be performed. Use of the power tool for operations different from those intended could result in a hazardous situation.
- ## 5. Service
- Have your power tool serviced by a qualified repair person using only identical replacement parts. This will ensure that the safety of the power tool is maintained.

MULTI FUNCTION TOOL SAFETY INSTRUCTIONS



WARNING! Read all safety warnings, instructions, illustrations and specifications provided with this power tool. Failure to follow all instructions listed below may result in electric shock, fire and/or serious injury.

This appliance is not intended for use by young or infirm persons unless supervised by a responsible person to ensure that they can use the appliance safely. Young children should be supervised to ensure that they do not play with play with the appliance.

Hold power tool by insulated gripping surfaces only, when performing an operation where the cutting accessory may contact hidden wiring or its own cord. Cutting accessory contacting a "live" wire may make exposed metal parts of the power tool "live" and shock the operator.

This appliance is not intended for use by persons (including children) with reduced physical, sensory or mental capabilities, or lack of experience and knowledge, unless they have been given supervision or instruction concerning use of the appliance by a person responsible for their safety.

The tool is recommended for use with a residual current device with a rated residual current of 30mA or less.



WARNING! Some dust created by power sanding, sawing, grinding, drilling and other construction activities contain chemicals known to cause cancer, birth defects or other reproductive harm. Some examples of these chemicals are:

- Lead from lead-based paints
- Crystalline silica from bricks and cement and other masonry products
- Arsenic and chromium from chemically treated timber

Your risk from exposure to these chemicals varies, depending on how often you do this type of work. To reduce your exposure to these chemicals: work in a well ventilated area and work with approved safety equipment, such as dust masks that are specially designed to filter out microscopic particles.