

QUALCAST

30cc



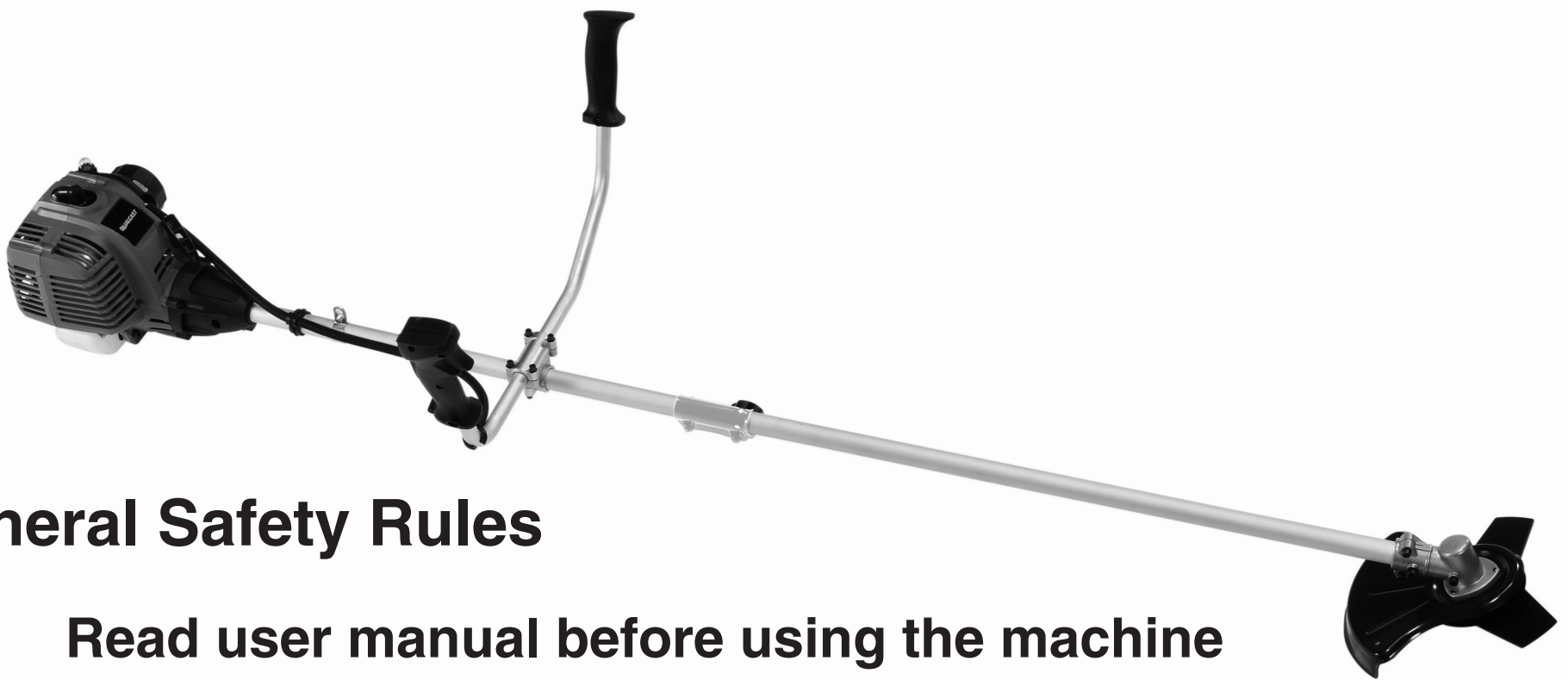

Petrol Brush Cutter QG-BC 30

Quick Start Guide

Your Safety is most important please read these safety rules before you use this machine



General Safety Rules

-  **Read user manual before using the machine**
-  **Wear safety goggles to guard your eyes from possible injury**
-  **Wear gloves to protect your hands**
-  **Wear safety shoes to protect your feet**
-  **Wear hearing protection**

Note - This quick start guide is intended for experienced users who have already assembled the tool, please refer to the manual for further details

Quick Start Guide

QUALCAST

Items Included

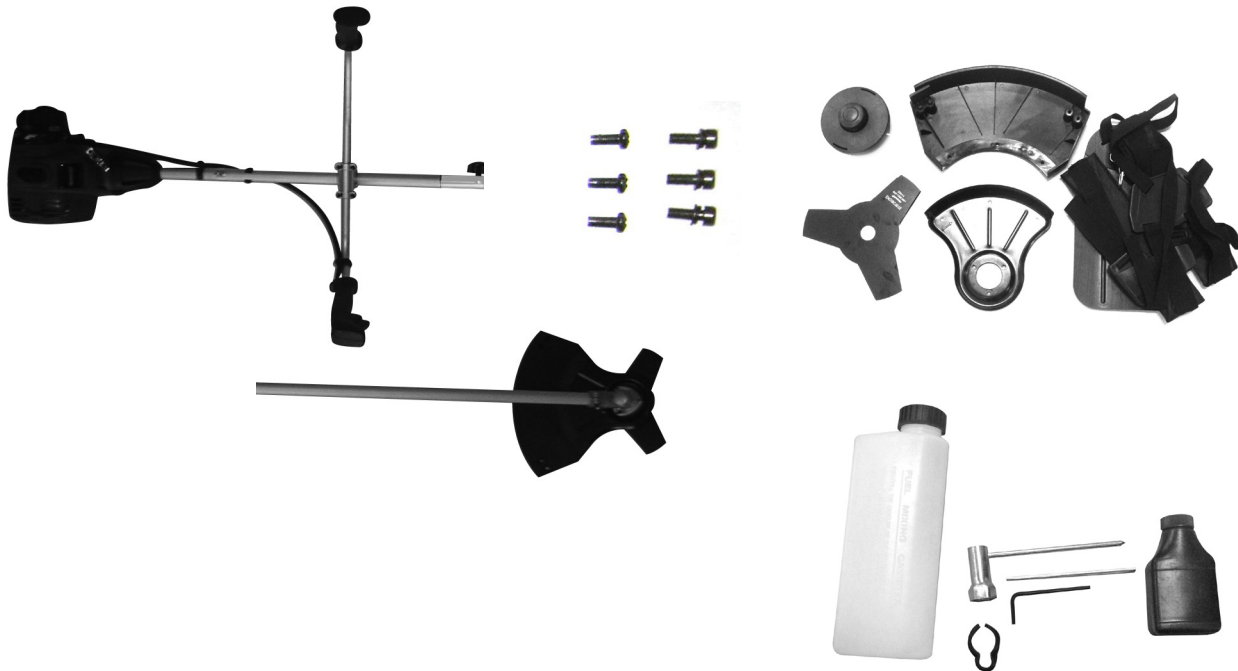

Do you have questions?
We can help
Call Customer Service
Mon-Thur 08:45 am - 5:00 pm
Friday 08:45 am - 3:15 pm



0151 649 1500
Spare Parts also available

1 Unpack the Brush Cutter

- Open carton carefully and remove all items
- Ensure you have all items (see above) before you discard the packaging

2 Assembling the Brush Cutter

Install the additional handle (LH and RH halves) as shown in Figures A - D, and align the additional handle halves as shown in Figure E. Connect the bottom shaft (1) to Upper shaft & engine (2) (See Figures F & G) making sure the square drive shaft on lower shaft (1) is inserted into square drive on upper shaft (2) correctly and ensure the spring loaded locking clip is aligned with the hole provided and in place and the securing knob is tightened. If the drive is not correctly inserted then the spool / blade will not turn.

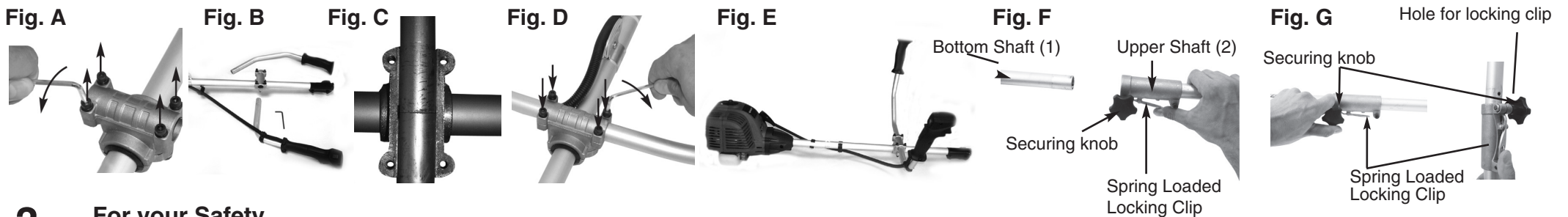

3 For your Safety

You must always fit the guards provided for your safety. Fit the brush cutter guard using the 3 screws provided, and also fit the Drive Collar over the splines on the drive shaft and also line up the hole in the collar with the 'u' shaped recess in the drive housing (see Fig 1).
a) For the Brush Cutter - fit the Blade, Blade Clamp Collar & nut. secure the drive shaft using the Lock Bar, and tighten the nut (Fig2 - 3).
b) For the Grass trimmer - fit the guard hood using the 3 screws supplied (Fig. 4 - 6). Secure the drive shaft using the Lock Bar, and screw on the line spool assembly (Fig. 7).
Important, LH thread = rotate the line spool/nut/spanner counter-clockwise to tighten and clockwise to loosen). Fit the carry strap to the unit with the clip to the hook on the upper shaft (Fig 8), and adjust the handles / harness to suit the working height.

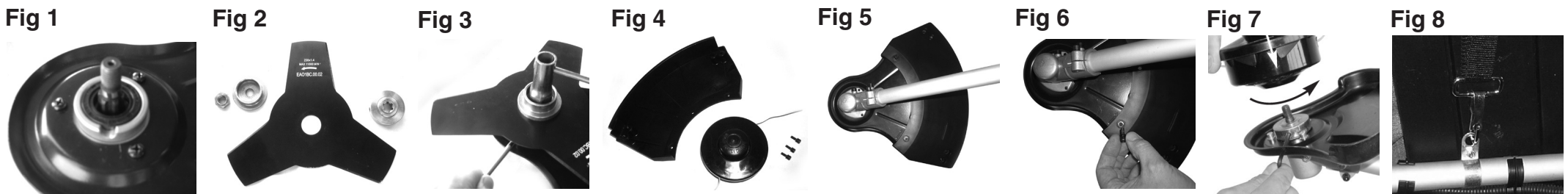

4 Fuel / Lubrication

- Mix the fuel in the mixer bottle provided
 - Shake the container gently to ensure that it is properly mixed.
- N.B Failure to use the correct oil/fuel mixture will cause the engine to seize**

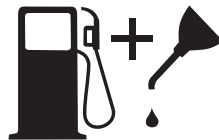

Use regular grade unleaded petrol and quality 2 stroke oil

Fuel Mixture is
40:1 (40 parts Fuel to 1 part 2 stroke oil)

5 Starting the Grass Trimmer

- Set the machine down on a hard, level surface.
- Set the choke to "F"
- Press the fuel pump (primer) 10 times.
- Set the ON/OFF switch to "I".
- Hold the appliance firmly in one hand by the handle, above the throttle lock.
- Pull the starter cord briskly 8 times.
- If the motor has been started, let the motor warm up (automatic choke reset function in place for the throttle lock).
If the engine does not start up immediately, repeat steps 1-7 above.

To stop the machine immediately, set the ON/OFF switch to "STOP" (0).

