



18V LITHIUM ION

# CORDLESS POLE HEDGE TRIMMER

## INSTRUCTION MANUAL

### SPECIFICATIONS

Input:	18V
Cutting Speed:	1,400 SPM
Cutting Capacity:	Ø16mm max.
Cutting Length:	410mm max.
Blade Length:	450mm
Extension Pole:	830mm
Length Min/Max.:	2.07/2.90m
Weight:	3.50kg

ozito.com.au

**5 YEAR**  
REPLACEMENT WARRANTY



### STANDARD EQUIPMENT



Trimmer Head



Rear Handle Tube



Extension Tube



Blade Cover

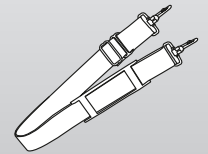

Shoulder Strap

**PXPHTS-1845**

## WARRANTY

IN ORDER TO MAKE A CLAIM UNDER THIS WARRANTY YOU MUST RETURN THE PRODUCT TO YOUR NEAREST BUNNINGS WAREHOUSE WITH YOUR BUNNINGS REGISTER RECEIPT. PRIOR TO RETURNING YOUR PRODUCT FOR WARRANTY PLEASE TELEPHONE OUR CUSTOMER SERVICE HELPLINE:

**Australia 1800 069 486**

**New Zealand 0508 069 486**

TO ENSURE A SPEEDY RESPONSE PLEASE HAVE THE MODEL NUMBER AND DATE OF PURCHASE AVAILABLE. A CUSTOMER SERVICE REPRESENTATIVE WILL TAKE YOUR CALL AND ANSWER ANY QUESTIONS YOU MAY HAVE RELATING TO THE WARRANTY POLICY OR PROCEDURE.

### WARNING

The following actions will result in the warranty being void.

- If the tool has been operated on a supply voltage other than that specified on the tool.
- If the tool shows signs of damage or defects caused by or resulting from abuse, accidents or alterations.
- Failure to perform maintenance as set out within the instruction manual.
- If the tool is disassembled or tampered with in any way.
- Professional, industrial or high frequency use.

The benefits provided under this warranty are in addition to other rights and remedies which are available to you at law.

Our goods come with guarantees that cannot be excluded at law. You are entitled to a replacement or refund for a major failure and for compensation for any other reasonably foreseeable loss or damage. You are also entitled to have the goods repaired or replaced if the goods fail to be of acceptable quality and the failure does not amount to a major failure.

Generally you will be responsible for all costs associated with a claim under this warranty, however, where you have suffered any additional direct loss as a result of a defective product you may be able to claim such expenses by contacting our customer service helpline above.

### 5 YEAR REPLACEMENT WARRANTY

Your Product is guaranteed for a period of 60 months from the original date of purchase and is intended for DIY (Do It Yourself) use only. If a product is defective it will be replaced in accordance with the terms of this warranty. **Lithium Ion batteries and chargers are covered by a 36 month warranty.** Warranty excludes consumable parts, for example: bearings, blades, blade cover.

# KNOW YOUR PRODUCT

## CORDLESS POLE HEDGE TRIMMER

1. Blade
2. Trimmer Head
3. Pivoting Head Button
4. Lock Nut
5. Extension Tube
6. Top Handle
7. Shoulder Strap Retainer
8. Sure Grip Handle
9. Rear Handle Release x 2
10. Safety Switch
11. Battery Seating
12. On/Off Trigger
13. Blade Cover
14. Shoulder Strap

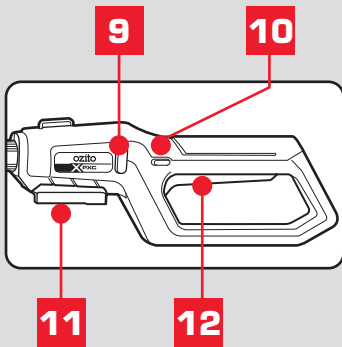

## ACCESSORIES

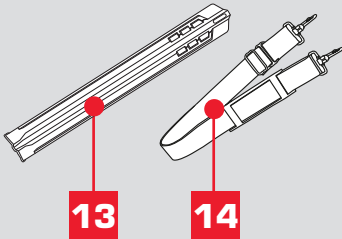

## BATTERY & CHARGER

This tool is compatible with all battery and chargers from the Ozito PXC Range.

## ONLINE MANUAL

Scan this QR Code with your mobile device to take you to the online manual.

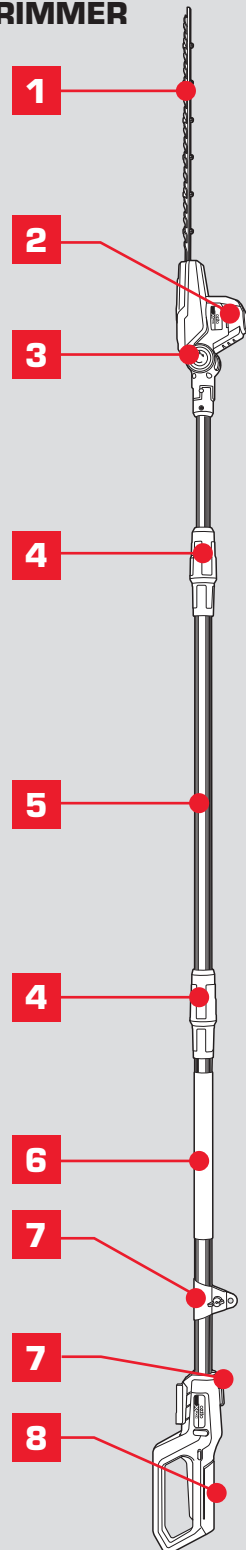

# SETUP & PREPARATION

## 1. ASSEMBLY

**WARNING!** ENSURE THE MACHINE IS SWITCHED OFF AND BATTERY IS DISCONNECTED BEFORE PERFORMING ANY OF THE FOLLOWING TASKS.

**WARNING!** WHEN HANDLING THE BLADE ASSEMBLY, WEAR NON-SLIP, HEAVY-DUTY PROTECTIVE GLOVES. DO NOT PLACE YOUR HAND OR FINGERS BETWEEN BLADES OR IN ANY POSITION WHERE THEY COULD GET PINCHED OR CUT. NEVER TOUCH BLADES OR SERVICE THE UNIT WITH THE BATTERY INSTALLED.

### Fitting the Tubes

The pole hedge trimmer can be used either with or without the extension tube.

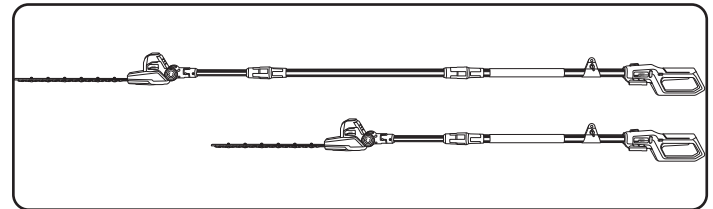

#### • Assembly without Extension Tube

1. Make sure the motor head and the rear handle are in the correct orientation. Push the tube of the motor head into the tube of the rear handle, aligning the Tab with the Recess as you do so. Push both halves together until it will not go any further.

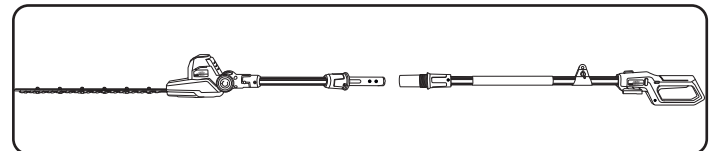

**Note:** The two parts can only be fitted in the correct orientation. Do not force the parts together.

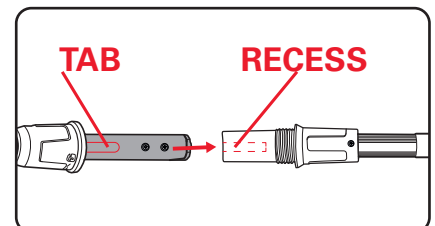

2. To secure the two parts together, slide the lock nut to the head and screw tight. To dismantle, proceed in reverse order.

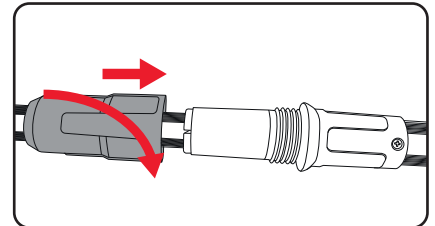

**Note:** The locking and unlocking directions are indicated on the lock nut.



**5 YEAR**  
REPLACEMENT WARRANTY

### • Assembly with Extension Tube

1. Push the tube of the motor head into the extension tube, aligning the Tab with the Recess of the extension tube as you do so. Push both halves together until it will not go any further.

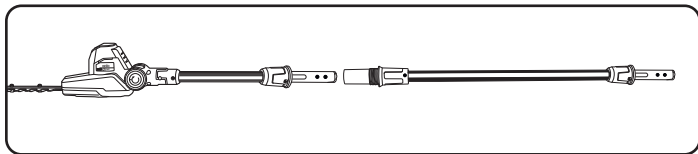

**Note:** The two parts can only be fitted in the correct orientation. Do not force the parts together.

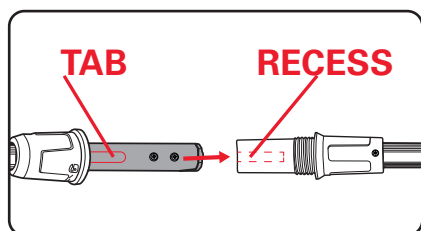

2. To secure the two parts together, slide the lock nut to the extension tube thread and screw tight.

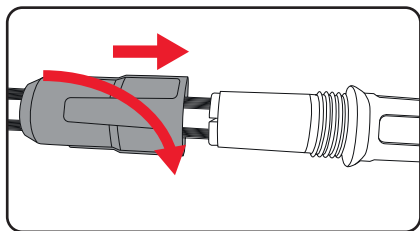

3. Make sure the motor head and the rear handle are in the correct orientation. Push the tube of the rear handle onto the tube of the extension tube, aligning the Tab with the Recess as you do so. Push both halves together until it will not go any further.

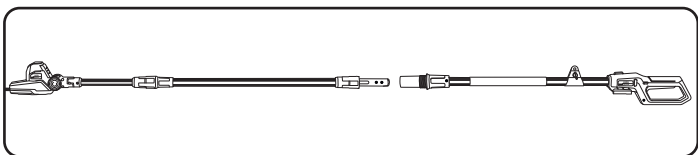

4. To secure the two parts together, screw tight with the lock nut.

**WARNING!** DO NOT OPERATE THE POLE HEDGE TRIMMER WITH MORE THAN ONE EXTENSION TUBE FITTED, THIS IS EXTREMELY DANGEROUS.

## 2. PREPARATION

### Adjusting the Rear Handle

Press and hold the two rear handle releases, one each side and turn the handle 90° to the left or 90° to the right. Release to lock in position.

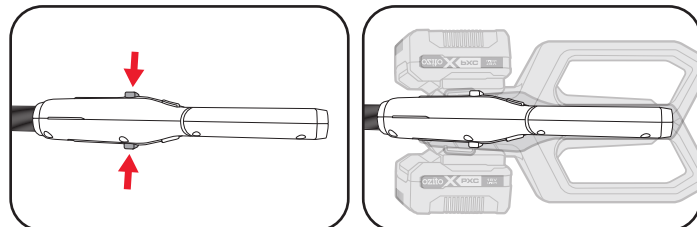

### Pivoting the Trimmer Head

**WARNING!** DO NOT HOLD THE BLADE IN AN ATTEMPT TO ADJUST THE BLADE ANGLE. DOING SO MAY RESULT IN POSSIBLE PERSONAL INJURY.

The head can be tilted to 7 different angles for ease of cutting in different conditions.

1. Grip the motor housing of the trimmer, press and hold the pivoting head button.

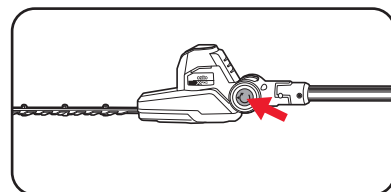

2. Tilt the head to any of the 7 preset angles, then release the button to lock the head in the selected position.

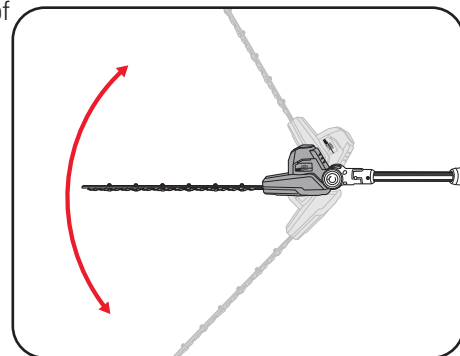

### Blade Cover

The blade cover protects the blade when not in use. Simply slide it off the blade before use. Once finished operating, place the cover back over the blade.

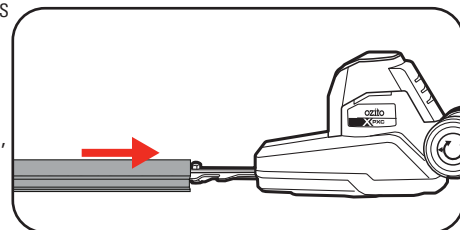

**WARNING!** NEVER START THE POLE HEDGE TRIMMER WHILE THE BLADE COVER IS FITTED.

# OPERATION

## Shoulder Strap

**WARNING!** ALWAYS USE THE SHOULDER STRAP WHEN WORKING WITH THE POLE HEDGE TRIMMER. ALWAYS SWITCH OFF THE EQUIPMENT BEFORE YOU RELEASE THE SHOULDER STRAP OTHERWISE THERE IS A RISK OF INJURY.

1. Fasten the carabiner hook on the ends of the shoulder strap to the shoulder strap retainers.
2. Wear the shoulder strap so that it lies over your shoulder.
3. In order to establish the optimum length of the shoulder strap, you should then make a few swinging movements without starting the motor. Using the strap adjuster on the shoulder strap, make adjustments until you achieve the most comfortable working and cutting position.

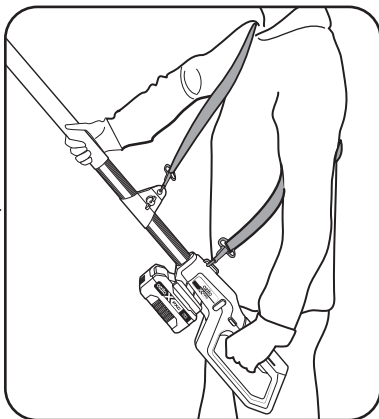

4. The shoulder strap is fitted with a quick-release buckle, press the hooks together if you need to put down the tool quickly.

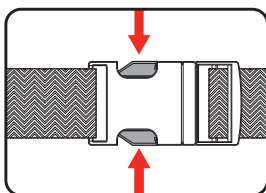

**Note:** If necessary you can adjust the position of the shoulder strap holder on the rear handle tube. To do so, loosen the wing nut and move the shoulder strap holder as required and then retighten the wing nut.

## Inserting & Removing the Battery

1. Align the ribs of the battery with the recess on the rear handle, then slide the battery in so that it clicks into place.

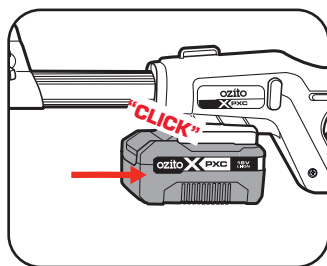

2. Press and hold the battery release tab to release the battery as you slide the battery out.

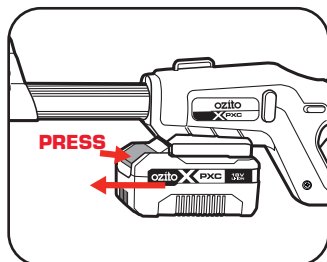

## 3. STARTING & STOPPING

**WARNING!** FAMILIARISE YOURSELF WITH SURROUNDING HAZARDS SUCH AS POWER LINES, PHONE LINES, METAL FENCES AND OTHER OBJECTS THAT COULD BE IN YOUR PATH, FAILURE TO DO SO COULD RESULT IN ELECTRICAL SHOCK, PERSONAL INJURY OR DAMAGE TO YOUR POLE HEDGE TRIMMER.

### Before starting the pole hedge trimmer

- Remove the blade cover.
- Make sure you have a secure and balanced footing.
- Make sure the blade is not touching the ground or any other objects.
- Hold the unit with both hands: one hand on the Sure Grip rear handle and one hand on the soft grip handle.
- Make sure you are wearing the appropriate protective clothing.
- Ensure all the locking device(s) of any moving elements (e.g. the tube lock nut, blade tilt and rear handle), if any, are in the locked position.

### Switching On and Off

**WARNING!** BEFORE YOU SWITCH ON THE UNIT, MAKE SURE THAT THE POLE HEDGE TRIMMER BLADE IS NOT MAKING CONTACT WITH ANY OBJECTS.

1. Hold the pole hedge trimmer firmly with both hands.

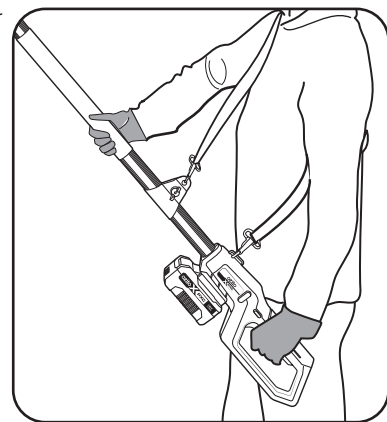

2. Press and hold the safety switch (a) with your thumb or finger, then squeeze the on/off trigger (b). The safety switch (a) can now be released.

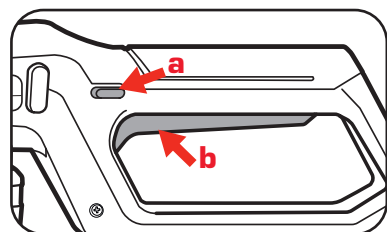

3. To stop operating, release the on/off trigger. The blade and motor will quickly stop.

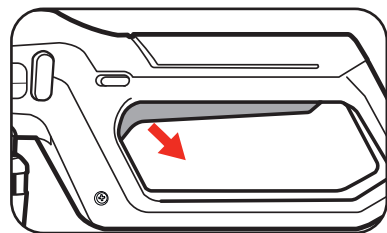

## 4. TRIMMING

### Using the Pole Hedge Trimmer

**WARNING!** ALWAYS WEAR STURDY, NON-SLIP FOOTWEAR, LONG TROUSERS, SAFETY GOGGLES AND GLOVES WHEN USING THE EQUIPMENT. NEVER USE EQUIPMENT BAREFOOT OR IN SANDALS.

**WARNING!** CLEAR THE AREA TO BE CUT BEFORE EACH USE. REMOVE ALL OBJECTS, SUCH AS CORDS, LIGHTS, WIRE, OR STRING WHICH CAN BECOME ENTANGLED IN THE CUTTING BLADE AND CREATE A RISK OF SERIOUS PERSONAL INJURY.

The pole hedge trimmer is designed for trimming and shaping shrubs, bushes and hedges. The equipment is intended for private use i.e. for use in home and gardening environments. Public facilities, parks, sporting grounds, along roadways, or agriculture and forestry are excluded.

**Note:** Do not use the pole hedge trimmer for cutting stems greater than  $\varnothing 16\text{mm}$ . Use the trimmer only for cutting normal shrubbery found around houses and buildings.

- A pole hedge trimmer can be used to cut shrubs and bushes as well as hedges. Never use the pole hedge trimmer to cut grass.
- To obtain the best cutting results, hold the pole hedge trimmer so that the cutter teeth are at an angle of approx.  $15^\circ$  in relation to the hedge.
- Maintain proper footing and balance. Do not overreach.
- Do not cut hedges when wet. (For best results are achieved when dry).
- The twin-bladed cutters rotate in opposite directions, thus enabling cutting in both directions.
- To ensure that you cut the hedge to a level height, we recommend tying a guide line of string or similar along the hedge. Cut off all branches that protrude beyond the guide line.

**WARNING!** IF THE BLADE JAMS ON ANY ELECTRICAL CORD OR LINE, DO NOT TOUCH THE BLADE! IT CAN BECOME ELECTRICALLY LIVE AND VERY DANGEROUS. CONTINUE TO HOLD THE POLE HEDGE TRIMMER BY THE INSULATED REAR HANDLE OR LAY IT DOWN AND AWAY FROM YOU IN A SAFE MANNER. DISCONNECT THE ELECTRICAL SERVICE TO THE DAMAGED LINE OR CORD BEFORE ATTEMPTING TO FREE THE BLADE. FAILURE TO HEED THIS WARNING MAY RESULT IN SERIOUS PERSONAL INJURY OR POSSIBLE DEATH.

**WARNING!** BE PARTICULARLY ATTENTIVE WHEN CUTTING ALONG THE GUIDE LINE. DO NOT CUT THROUGH THE GUIDE LINE. THIS COULD GET ENTANGLED IN THE BLADES AND LEAD TO INJURIES OR DAMAGE TO PROPERTY.

### • Working Position

Maintain proper footing and balance and do not overreach. Hold the pole hedge trimmer firmly in both hands before turning the pole hedge trimmer on. Always hold the pole hedge trimmer with one hand on the Sure Grip rear handle and one hand on the soft grip handle.

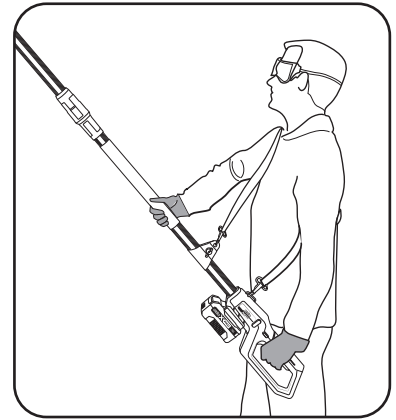

**WARNING!** DO NOT OPERATE THE POLE HEDGE TRIMMER ON UNEVEN GROUND IN A TREE, ON A LADDER, FROM A ROOFTOP, OR ANY UNSTABLE SUPPORT, THIS IS EXTREMELY DANGEROUS.

### • Trimming new growth

Use a wide sweeping motion, feed the blade teeth through the twigs. A slight downward tilt of the cutting blades in the direction of motion gives the best cutting results.

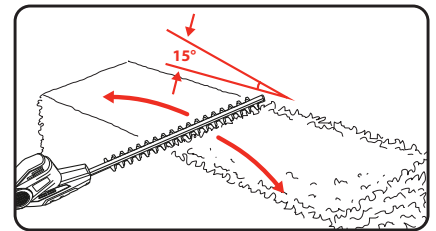

### • Level hedges.

To obtain exceptionally level hedges a piece of string can be stretched along the length of the hedge as a guide.

### • Side-trimming hedges

Hold the pole hedge trimmer and begin at the bottom and sweep up.

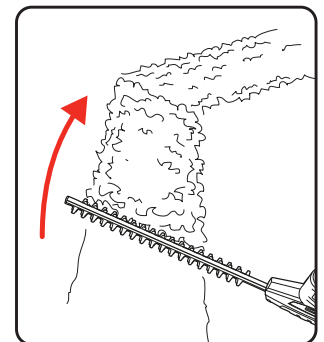

### • Cutting sequence.

First cut both sides, starting at the bottom and work to the top: this prevents cuttings from falling into the area where you are still working.

**WARNING!** IF THE BLADES COME IN CONTACT WITH A HARD OBJECT, VISUALLY INSPECT THE BLADE FOR DAMAGE. IF THE BLADE IS DAMAGED, DO NOT CONTINUE TO OPERATE THE POLE HEDGE TRIMMER.

# OPERATION cont.

## 4. TRIMMING cont.

### • Trimming the top

Where the branches have grown extremely long, cut back the hedge in several stages.

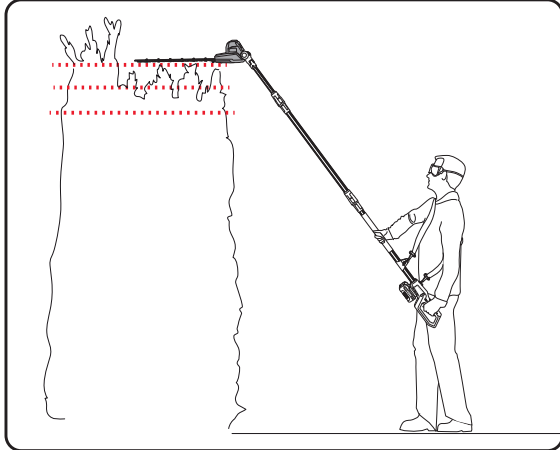

### If the Blade gets Blocked

1. Stop the equipment.
2. Remove the battery.
3. Remove the jammed material from the blade (wear work gloves to prevent injury when you do so).

### Run Time

The operating time of the PXC battery (the area that can be covered with a single battery charge) is largely dependent on the state of the shrubbery (e.g. Density, moisture, thickness, etc.) and the hedge trimmer speed (rate of work).

Frequently turning the equipment on and off while hedge trimming will also reduce the amount runtime and area that you can cover. If the operating time of the PXC battery (runtime and area coverage) is still unsatisfactory in spite of the above measures, you can remedy the problem by using PXC battery with a larger capacity (Ah).

# MAINTENANCE



**WARNING!** ALWAYS ENSURE THE POLE HEDGE TRIMMER HAS COMPLETELY STOPPED AND THE BATTERY IS REMOVED PRIOR TO ANY MAINTENANCE.

### Sharpening the cutting blade

1. Start and stop your pole hedge trimmer until the cutter blade and the guard are slightly offset.
2. Remove the battery pack from your pole hedge trimmer.
3. Clamp the blade assembly in a vise and file the exposed cutting surface of each blade tooth. Remove as little material as possible.
4. Remove the pole hedge trimmer from the vise and insert the battery pack. Repeat steps 1-3 for the unsharpened edges of the blade teeth.

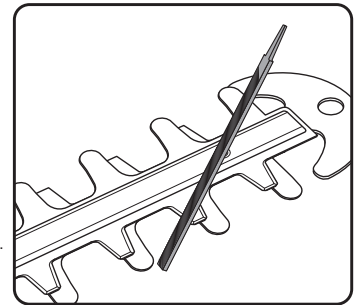
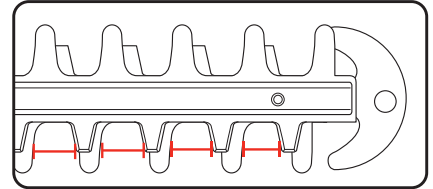

**Note:** Do not operate your pole hedge trimmer with dull or damaged cutting blades. This may cause overload and will give unsatisfactory cutting results.

### Lubricating the blade

The blade rail should be cleaned and treated with light machine oil or spray lubricant (such as WD40, CRC 5.56 or RP7) after each use. When a job lasts for a longer period of time it is recommended that the blade rail also be treated with spray lubricant at regular intervals during operation.

1. Remove the battery pack from the hedge trimmer.
2. Lay the pole hedge trimmer on a flat surface. Apply a light weight machine oil along the edge of the top blade. If you will be using the hedge trimmer for an extended period it is advisable to stop, remove the battery, and oil the blade before recommencing the task.

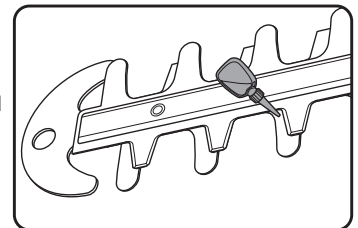

**WARNING!** DO NOT OIL WHILE THE POLE HEDGE TRIMMER IS RUNNING.

### Cleaning and Storage













- Use a soft brush to remove debris from all air intakes and the cutting blade.
- To remove sap and other sticky residue, spray the blades with a resin solvent. Run the motor briefly so that the solvent is evenly distributed then wipe the surface with a dry cloth.
- Never use water for cleaning your trimmer. Avoid using solvents when cleaning plastic parts. Most plastics are susceptible to damage from various types of commercial solvents. Use clean cloths to remove dirt, dust, oil, grease, etc.
- If the trimmer vibrates abnormally, stop motor immediately. Abnormal vibration usually indicates a mechanical problem. Continued operation could lead to injury or damage.
- Always place the blade cover on the blade before storing or transporting the pole hedge trimmer. Use caution to avoid the sharp teeth of the blade.
- When not in use remove the battery and the pole hedge trimmer should be stored in a dry, frost free location not within the reach of children.
- Keep air intake clean and air vents free of debris to avoid overheating the motor.
- Keep away from corrosive agents such as garden chemicals.
- Never store the pole hedge trimmer upright, where it may fall and cause damage. Store in its original packaging if possible.
- Store the pole hedge trimmer in a dry location at above freezing temperature which is not accessible to unauthorised persons.
- The ideal storage temperature is between 5 and 30°C.

## TROUBLESHOOTING

Problem	Cause	Remedy
Pole Hedge Trimmer is not starting	Possible clogging	Clean the trimmer blade of any leaves or debris.
	Battery is low in charge	Charge battery
	Battery not inserted properly	Insert battery pack correctly
Trimmer is not operating at full capacity	Possible clogging	Clean the trimmer blade of any leaves or debris.
	Blades are binding due to lack of lubrication	Check the blades and lubricate
Motor stops while trimming	Battery has no power	Charge battery

**Note:** Ozito Industries will not be responsible for any damage or injuries caused by the repair of the pole hedge trimmer by an unauthorised person or by mishandling of the pole hedge trimmer. This tool is designed for DIY use - use in commercial or industrial environments will void the warranty.

## DESCRIPTION OF SYMBOLS

<b>V</b>	Volts	<b>Hz</b>	Hertz
<b>AC/~</b>	Alternating current	<b>W</b>	Watts
<b>/min</b>	Revolutions or reciprocation per minute	<b>No</b>	No load speed
<b>mm</b>	Milimetre	<b>m/s</b>	Metres per second
<b>dc/---</b>	Direct current		Regulatory compliance mark
<b>mA</b>	Milliamperes		Warning
	Keep hands away from blade		Do not expose to rain or leave outdoors while raining
	Wear sturdy, non-slip footwear		Wear safety gloves
	Read instruction manual before use to reduce the risk of injury		
	Keep bystanders away		Watch out for falling and catapulting parts
	Use eye, ear and head protection when operating the pole hedge trimmer		
	Keep sufficient distance away from electrical power lines.		
	Sound pressure level 102dB		

## CARING FOR THE ENVIRONMENT



Power tools that are no longer usable should not be disposed of with household waste but in an environmentally friendly way. Please recycle where facilities exist. Check with your local council authority for recycling advice.



Recycling packaging reduces the need for landfill and raw materials. Reuse of recycled material decreases pollution in the environment. Please recycle packaging where facilities exist. Check with your local council authority for recycling advice.

## SPARE PARTS

**Spare parts can be ordered from the Special Orders Desk at your local Bunnings Warehouse.**

**For further information, or any parts not listed here, visit [www.ozito.com.au](http://www.ozito.com.au) or contact Ozito Customer Service:**

**Australia 1800 069 486**

**New Zealand 0508 069 486**

**E-mail: [enquiries@ozito.com.au](mailto:enquiries@ozito.com.au)**



# ELECTRICAL SAFETY



**WARNING!** When using electric machines, basic safety precautions, including the following, should always be followed to reduce risk of fire, electric shock, personal injury and material damage.

-Read the whole manual carefully and make sure you know how to switch the machine off in an emergency, before operating the machine. Save these instructions and other documents supplied with this machine for future reference.

-This appliance is not intended for use by persons (including children) with reduced physical, sensory or mental capabilities, or lack of experience and knowledge, unless they have been given supervision or instruction concerning use of the appliance by a person responsible for their safety.

Children should be supervised to ensure that they do not play with the appliance.

-This appliance is compatible and only to be used with all batteries & chargers from the Ozito PXC range. Refer to the PXC battery and charger manuals for information regarding charging, use and storage.

-Remove the batteries from the appliance before being charged.

-Do not combine different types of batteries or new and used batteries.

-If the appliance is to be stored unused for a long period, the batteries should be removed.

-Do not use modified or damaged batteries.



# GENERAL MACHINE SAFETY WARNINGS



**WARNING!** Read all safety warnings, instructions, illustrations and specifications provided with this machine. Failure to follow all instructions listed below may result in electric shock, fire and/or serious injury.

Save all warnings and instructions for future reference.

The term "machine" in the warnings refers to your mains-operated (corded) machine or battery-operated (cordless) machine.

## 1) Work area safety

- a) **Keep work area clean and well lit.** Cluttered or dark areas invite accidents.
- b) **Do not operate machines in explosive atmospheres, such as in the presence of flammable liquids, gases or dust.** Machines create sparks which may ignite the dust or fumes.
- c) **Keep children and bystanders away while operating a machine.** Distractions can cause you to lose control.

## 2) Electrical safety

- a) **Machine plugs must match the outlet. Never modify the plug in any way. Do not use any adapter plugs with earthed (grounded) machines.** Unmodified plugs and matching outlets will reduce risk of electric shock.
- b) **Avoid body contact with earthed or grounded surfaces, such as pipes, radiators, ranges and refrigerators.** There is an increased risk of electric shock if your body is earthed or grounded.
- c) **Do not expose machines to rain or wet conditions.** Water entering a machine will increase the risk of electric shock.
- d) **Do not abuse the cord. Never use the cord for carrying, pulling or unplugging the machine. Keep cord away from heat, oil, sharp edges or moving parts.** Damaged or entangled cords increase the risk of electric shock.
- e) **When operating a machine outdoors, use an extension cord suitable for outdoor use.** Use of a cord suitable for outdoor use reduces the risk of electric shock.
- f) **If operating a power tool in a damp location is unavoidable, use a residual current device (RCD) protected supply.** Use of an RCD reduces the risk of electric shock.

## 3) Personal safety

- a) **Stay alert, watch what you are doing and use common sense when operating a machine. Do not use a machine while you are tired or under the influence of drugs, alcohol or medication.** A moment of inattention while operating machines may result in serious personal injury.
- b) **Use personal protective equipment. Always wear eye protection.** Protective equipment such as a dust mask, non-skid safety shoes, hard hat or hearing protection used for appropriate conditions will reduce personal injuries.
- c) **Prevent unintentional starting. Ensure the switch is in the off-position before connecting to power source and/or battery pack, picking up or carrying the machine.** Carrying machines with your finger on the switch or energising machines that have the switch on invites accidents.
- d) **Remove any adjusting key or wrench before turning the machine on.** A wrench or a key left attached to a rotating part of the machine may result in personal injury.
- e) **Do not overreach. Keep proper footing and balance at all times.** This enables better control of the machine in unexpected situations.
- f) **Dress properly. Do not wear loose clothing or jewellery. Keep your hair and clothing away from moving parts.** Loose clothes, jewellery or long hair can be caught in moving parts.
- g) **If devices are provided for the connection of dust extraction and collection facilities, ensure these are connected and properly used.** Use of dust collection can reduce dust-related hazards.
- h) **Do not let familiarity gained from frequent use of machines allow you to become complacent and ignore machine safety principles.** A careless action can cause severe injury within a fraction of a second.

## 4) Machine use and care

- a) **Do not force the machine. Use the correct machine for your application.** The correct machine will do the job better and safer at the rate for which it was designed.
- b) **Do not use the machine if the switch does not turn it on and off.** Any machine that cannot be controlled with the switch is dangerous and must be repaired.
- c) **Disconnect the plug from the power source and/or remove the battery pack, if detachable, from the machine before making any adjustments, changing accessories, or storing machines.** Such preventive safety measures reduce the risk of starting the machine accidentally.
- d) **Store idle machines out of the reach of children and do not allow persons unfamiliar with the machine or these instructions to operate the machine.** Machines are dangerous in the hands of untrained users.
- e) **Maintain machines and accessories. Check for misalignment or binding of moving parts, breakage of parts and any other condition that may affect the machine's operation. If damaged, have the machine repaired before use.** Many accidents are caused by poorly maintained machines.
- f) **Keep cutting machines sharp and clean.** Properly maintained cutting machines with sharp cutting edges are less likely to bind and are easier to control.
- g) **Use the machine, accessories and machine bits etc. in accordance with these instructions, taking into account the working conditions and the work to be performed.** Use of the machine for operations different from those intended could result in a hazardous situation.
- h) **Keep handles and grasping surfaces dry, clean and free from oil and grease.** Slippery handles and grasping surfaces do not allow for safe handling and control of the machine in unexpected situations.

## 5) Battery machine use and care

- a) **Recharge only with the charger specified by the manufacturer.** A charger that is suitable for one type of battery pack may create a risk of fire when used with another battery pack.
- b) **Use machines only with specifically designated battery packs.** Use of any other battery packs may create a risk of injury and fire.
- c) **When battery pack is not in use, keep it away from other metal objects, like paper clips, coins, keys, nails, screws or other small metal objects, that can make a connection from one terminal to another.** Shorting the battery terminals together may cause burns or a fire.
- d) **Under abusive conditions, liquid may be ejected from the battery; avoid contact. If contact accidentally occurs, flush with water. If liquid contacts eyes, additionally seek medical help.** Liquid ejected from the battery may cause irritation or burns.
- e) **Do not use a battery pack or machine that is damaged or modified.** Damaged or modified batteries may exhibit unpredictable behaviour resulting in fire, explosion or risk of injury.
- f) **Do not expose a battery pack or machine to fire or excessive temperature.** Exposure to fire or temperature above 130 °C may cause explosion.
- g) **Follow all charging instructions and do not charge the battery pack or machine outside the temperature range specified in the instructions.** Charging improperly or at temperatures outside the specified range may damage the battery and increase the risk of fire.

## 6) Service

- a) **Have your machine serviced by a qualified repair person using only identical replacement parts.** This will ensure that the safety of the machine is maintained.
- b) **Never service damaged battery packs.** Service of battery packs should only be performed by the manufacturer or authorized service providers.



# POLE HEDGE TRIMMER SAFETY WARNINGS



**WARNING!** This appliance is not intended for use by persons (including children) with reduced physical, sensory or mental capabilities, or lack of experience and knowledge, unless they have been given supervision or instruction concerning use of the appliance by a person responsible for their safety.

Young children should be supervised to ensure that they do not play with the appliance.

- **Keep all parts of the body away from the blade. Do not remove cut material or hold material to be cut when blades are moving.** Blades continue to move after the switch is turned off. A moment of inattention while operating the hedge trimmer may result in serious personal injury.
- **Carry the pole hedge trimmer by the handle with the blade stopped and taking care not to operate any power switch.** Proper carrying of the pole hedge trimmer will decrease the risk of inadvertent starting and resultant personal injury from the blades.
- **When transporting or storing the pole hedge trimmer, always fit the blade cover.** Proper handling of the pole hedge trimmer will decrease the risk of personal injury from the blades.
- **When clearing jammed material or servicing the unit, make sure all power switches are off and the battery pack is removed or disconnected.** Unexpected actuation of the pole hedge trimmer while clearing jammed material or servicing may result in serious personal injury.
- **Hold the pole hedge trimmer by insulated gripping surfaces only, because the blade may contact hidden wiring.** Blades contacting a "live" wire may make exposed metal parts of the hedge trimmer "live" and could give the operator an electric shock.
- **Keep all power cords and cables away from cutting area.** Power cords or cables may be hidden in hedges or bushes and can be accidentally cut by the blade.
- **Do not use the pole hedge trimmer in bad weather conditions, especially when there is a risk of lightning.** This decreases the risk of being struck by lightning.
- **To reduce the risk of electrocution, never use the pole hedge trimmer near any electrical power lines.** Contact with or use near power lines may cause serious injury or electric shock resulting in death.
- **Always use two hands when operating the pole hedge trimmer.** Hold the pole hedge trimmer with both hands to avoid loss of control.
- **Always use head protection when operating the pole hedge trimmer overhead.** Falling debris can result in serious personal injury.
- Never allow children or people unfamiliar with these instructions to use the Pole Hedge Trimmer.
- Avoid using the Pole Hedge Trimmer, while people, especially children or pets, are nearby.
- Use the Pole Hedge Trimmer only in daylight or good artificial light.
- Never operate the Pole Hedge Trimmer with damaged guards or without guards in place.
- Switch on the Pole Hedge Trimmer only when the hands and feet are away from the cutting blades.
- Use only the manufacturer's recommended replacement parts and accessories.
- Always remove the battery from the Pole Hedge Trimmer when leaving the Hedge Trimmer unattended.
- Always remove the battery from the Pole Hedge Trimmer before carrying out maintenance or cleaning work.
- Inspect and maintain the Pole Hedge Trimmer regularly. Have the Hedge Trimmer repaired only by an authorized repairer.
- When not in use, store the Pole Hedge Trimmer out of the reach of children.
- Face the cutting blades away from yourself, other people and animals while the battery is connected to the Pole Hedge Trimmer (especially during operation).
- Use both handles at all times.
- Keep ventilation openings clear of debris. Keep handles dry, clean and free of oil and grease.
- Do Not use if under influence of alcohol, drugs, medication or fatigue.
- Ensure regular breaks are taken if the task entails long duration time.
- Do not run while using pole hedge trimmer.
- Never operate the pole hedge trimmer in the rain or in wet conditions.
- Never modify or lock on/off trigger and safety switch on.
- Never reach underneath the Pole Hedge Trimmer (the cutting blade area) until it has completely stopped and the power has been disconnected.
- Avoid using power tools and machines for long periods of time without breaks. Vibration from tools and machines can be transmitted into your hands and arms.



**WARNING!** When servicing, use only identical replacement parts. Use of any other parts may create a hazard or cause product damage. To ensure safety and reliability, all repairs should be performed by a qualified service technician.



**Danger!** Always remove the battery from the pole hedge trimmer:

- when the equipment is left unattended,
- when the equipment is being checked, cleaned, or having maintenance work done,
- or if the equipment vibrates abnormally.