

 **Operating Instructions for
Petrol Grass Trimmer**



7



Art.-No.: 941479

**34.016.87
I.-No.: 01014**

SGT 24

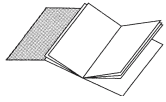

Ⓢ Please pull out page 2

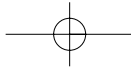
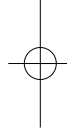
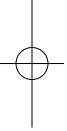

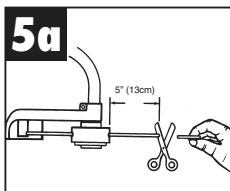
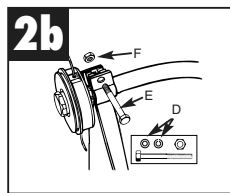
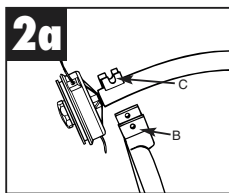
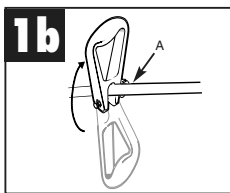
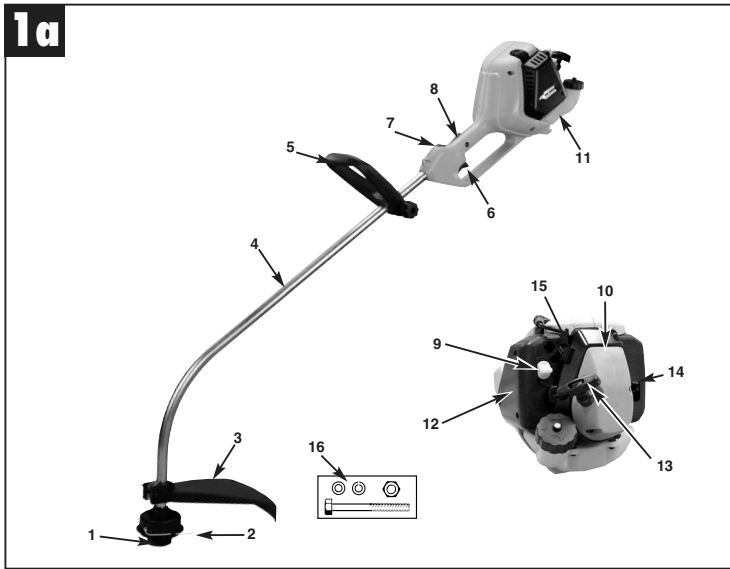

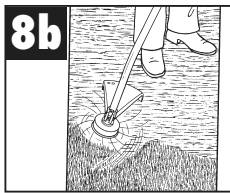
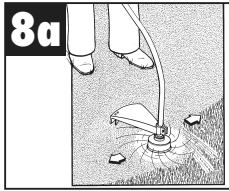
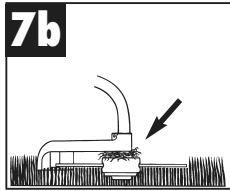
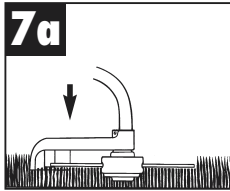
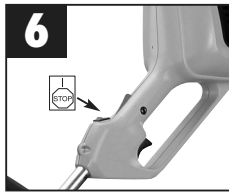
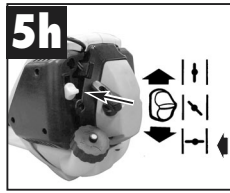
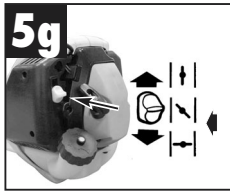
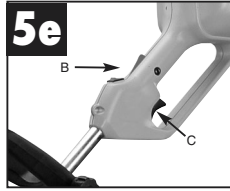
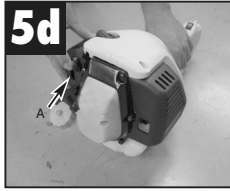

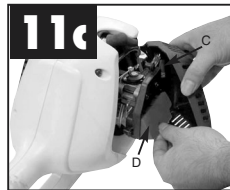
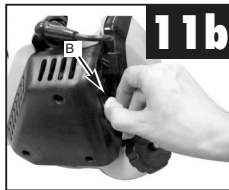
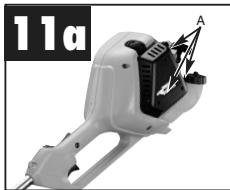
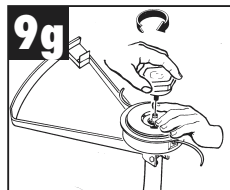
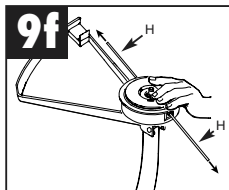
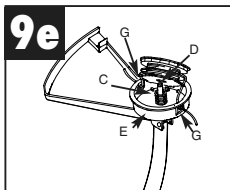
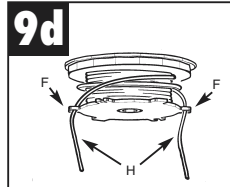
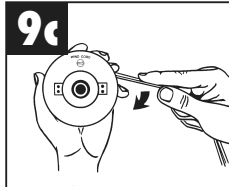
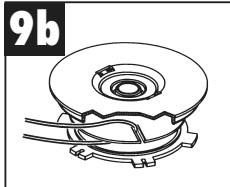
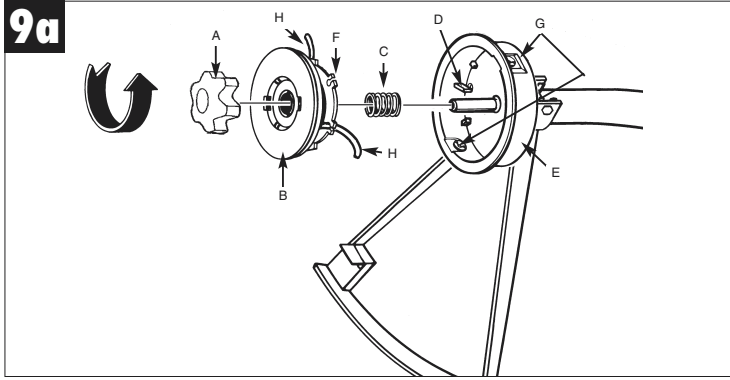

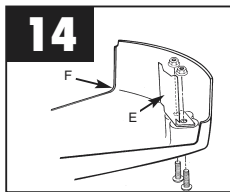
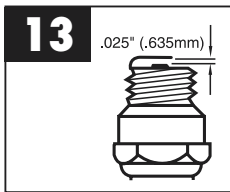
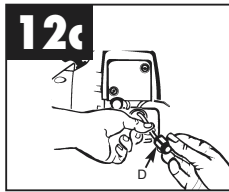
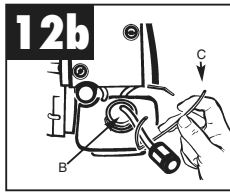
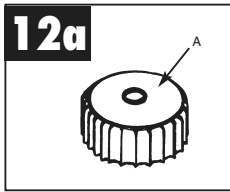

General Safety Rules

Symbols marked on the product



Read the user manual before using the machine



Wear safety goggles to protect your eyes



Wear ear protection to protect against noise



Wear dust mask to protect against dust



Wear gloves to protect your hands



Wear safety boots to protect against electric shock

WARNING! When using petrol tools, basic safety precautions, including the following, should always be followed to reduce the risk of serious personal injury and/or damage to the unit.

Read all these instructions before operating this product and retain them for future reference.

This power unit can be dangerous! Operator is responsible for following unit manual instructions and warnings. Read entire operator's manual before using unit! Be thoroughly familiar with the controls and the proper use of the unit. Restrict the use of this unit to persons who read, understand, and follow unit, manual instructions and warnings. Never allow children to operate this unit.

DANGER: Never use blades, wire or flailing devices. Unit is designed for line trimmer use only. Use of any other accessories or attachments will increase the risk of injury.



WARNING: Keep children, bystanders, and animals 50 feet (15 meters) away. If approached stop unit immediately.

1. **Wear close fitting, tough work clothing** that will provide protection, such as long slacks or trousers, safety work shoes, heavy duty work gloves, hard hat, a safety face shield, or safety glasses for eye protection and a good grade of ear plugs or other sound barriers for hearing protection.
2. **Store in a safe place.** Open fuel cap slowly to release any pressure which may have formed in fuel tank. To prevent a fire hazard, move at least 10 feet (3 meters) from fueling area before starting.
3. **Turn unit off** before setting it down.
4. **Always hold unit firmly with both hands**, the thumb and fingers encircling the handles.
5. **Keep all screws and fasteners tight.** Never operate your equipment when it is improperly adjusted or not completely and securely assembled.
6. **Keep handles dry**, clean and free of fuel mixture.
7. **Keep stringhead as close to ground as practical.** Avoid hitting small objects with stringhead. When cutting on a slope, stand below stringhead. NEVER cut or trim on a hill or slope, etc. if there is the slightest chance of slipping, sliding or losing firm footing.
8. **Check area you will be trimming for debris** that may be struck or thrown during operation.
9. **Keep all parts of your body and clothing away from stringhead** when starting or running engine. Before starting engine, make sure stringhead will not come in contact with any obstacle.
10. **Stop engine** before examining cutting line.
11. **Store equipment away from possible flammable materials**, such as gas-powered water heaters, clothes dryers, or oil-fired furnaces, portable heaters, etc.
12. **Always keep** the debris shield, stringhead, and engine free of debris build-up.
13. **Operation of equipment** should always be restricted to mature and properly instructed individuals.

GB**WHAT NOT TO DO**

1. DO NOT USE ANY OTHER FUEL than that recommended in your manual. Always follow instructions in the Fuel and Lubrication section of this manual. Never use gasoline unless it is properly mixed with 2 stroke oil. Permanent damage to engine will result, voiding manufacturer's warranty.
2. DO NOT SMOKE while refueling or operating equipment.
3. DO NOT OPERATE UNIT WITHOUT A MUFFLER and properly installed muffler shield.
4. DO NOT TOUCH or let your hands or body come in contact with the muffler. Hold unit with thumbs and fingers encircling the handles.
5. DO NOT OPERATE UNIT IN AWKWARD POSITIONS, off balance, outstretched arms, or one-handed. Always use two hands when operating unit with thumbs and fingers encircling the handles.
6. DO NOT RAISE STRINGHEAD above ground level while unit is operating. Injury to operator could result.
7. DO NOT USE UNIT FOR ANY PURPOSES OTHER than trimming lawn or garden areas.
8. DO NOT OPERATE UNIT FOR PROLONGED PERIODS. Rest periodically.
9. DO NOT OPERATE UNIT WHILE UNDER THE INFLUENCE OF ALCOHOL OR DRUGS.
10. DO NOT OPERATE UNIT UNLESS DEBRIS SHIELD AND/OR GUARD IS INSTALLED AND IN GOOD CONDITION.
11. DO NOT ADD, REMOVE OR ALTER ANY COMPONENTS OF THIS PRODUCT. Doing so could cause personal injury and/or damage the unit voiding the manufacturer's warranty.
12. DO NOT operate your unit near or around flammable liquids or gases whether in or out of doors. An explosion and/or fire may result.

General identification

1. STRINGHEAD
2. CUTTER LINE
3. DEBRIS SHIELD*
4. DRIVE SHAFT ASSEMBLY
5. HANDLE
6. THROTTLE TRIGGER
7. IGNITION OFF SWITCH
8. SAFETY TRIGGER
9. CHOKE LEVER KNOB
10. STARTER ROPE HOUSING
11. FUEL TANK
12. AIR FILTER COVER
13. STARTER HANDLE
14. MUFFLER SHIELD
15. PRIMER BULB
16. DEBRIS SHIELD NUT & BOLT & WASHER*

*Supplied in User Kit

NOTE: DO NOT use blades on these models.**SAFETY FEATURES**

- 3** DEBRIS SHIELD must be installed to prevent debris from being thrown at the operator and prevent the string from extending longer than necessary.
- 14** MUFFLER SHIELD helps prevent hands, body and/or combustible materials from making contact with a hot muffler.

Specifications

| | |
|----------------------------------|---------------------------------------|
| Engine Type | Air-cooled, 2-stroke, Chrome Cylinder |
| Displacement | 24 cm ³ |
| Power: | 0,8 kW |
| Dry Weight | 4,8 kg |
| Fuel Capacity | 500 ml |
| Drive Shaft Length | 112 cm |
| Cutting Width | 38 cm |
| Handle | Adjustable |
| Ignition | Electronic |
| Drive | Centrifugal Clutch |
| Nylon cutting line \varnothing | 2,0 mm |

Assembly instructions• **Handle Assembly**

NOTE: The Handle is attached to the shaft but has been turned under for ease of packing.

1. Loosen adjustment knob and rotate handle to top of shaft. Position handle 160mm - 220mm from throttle (Fig. 1b).
2. Tighten adjustment knob securely.

• **DEBRIS SHIELD (Fig. 2A - 2B)**

⚠ Warning: The debris shield must be installed to properly dispense cutter line and protect operator. Shield fits snug on shaft. Some force may be required.

1. Seat shield (B) onto shaft bracket (C).
2. Insert washers (D) onto bolt.
3. Insert bolt (E) and nut (F), tighten securely.

Fuel and lubrication• **Fuel**

Use regular grade unleaded gasoline mixed with 2-stroke engine oil for best results. Use mixing ratios in Section **FUEL MIXING TABLE**.

⚠ Warning: Never use straight gasoline in your unit. This will cause permanent engine damage and void the manufacturer's warranty for that product. Never use a fuel mixture that has been stored for over 90 days.

⚠ Warning: Do not use any 2-stroke oil product with a recommended mixing ratio of 100:1. If insufficient lubrication is the cause of engine damage, it voids the manufacturer's engine warranty.

• **MIXING FUEL**

Mix fuel 2-stroke oil in an approved container. Use mixing table for correct ratio of fuel to oil. Shake container to ensure thorough mix.

⚠ Warning: Lack of lubrication voids engine warranty. Gasoline and oil must be mixed at 40:1.

• **Fuel Mixing Table**

| Gasoline | Lubricant |
|------------------|---|
| 5 Liters | 125 ml (cc) |
| Mixing Procedure | 40 Parts Gasoline to 1 part Lubricant 1 ml = 1 cc |

RECOMMENDED FUELS

Some conventional gasolines are being blended with oxygenates such as alcohol or an ether compound to meet clean air standards. Your engine is designed to operate satisfactorily on any gasoline intended for automotive use including oxygenated gasolines.

OPERATING INSTRUCTIONS• **STARTING A COLD ENGINE**

NOTE: To minimize load on engine during starting and warm-up, trim excess cutter line to 5" (13cm) (Fig. 5A).

1. Move ignition switch to the "RUN (I)" position (Fig. 5B).
2. Your unit is designed with a 3 position choke: CHOKE "I", PARTIAL "II", and RUN "III". Move choke lever to CHOKE "I" position (Fig. 5C).
3. Prime the carburetor. Pump the primer bulb (A) 10 times (Fig. 5D).
4. Grip handle firmly – depress safety trigger (B) & throttle trigger (C) to the FULL THROTTLE position (Fig. 5E).
5. Pull starter rope out a short way until resistance is felt (approximately 100mm) (Fig. 5F). A smooth rapid pull is required for a strong spark. Pull starter rope briskly 4 times.
6. Move choke lever to PARTIAL "II" position (Fig. 5G).
7. Pull starter rope again 4 times while trigger is in the full throttle position (Fig. 5F).
8. Once engine starts, leave in the PARTIAL "II" position for 10 seconds.
9. Move the choke to RUN "III" position (Fig. 5H).
10. If engine fails to start, repeat steps 1 through 7.

NOTE: If engine fails to start after repeated attempts, refer to Troubleshooting section.

NOTE: Always pull starter rope straight out. Pulling starter at an angle will cause rope to rub against the eyelet. This friction will cause the rope to fray and wear more quickly. Always hold starter handle when rope retracts. Never allow rope to snap back from extended position. This could cause rope to snag or fray and also damage the starter assembly.

GB

- **WARM ENGINE START**

1. Place trimmer on firm flat surface.
2. Move ignition switch to the "RUN (I)" position (Fig. 6).
3. Grip handle firmly, squeeze throttle trigger to FULL position.
4. Pull starter rope briskly until engine starts, but no more than 6 times.
5. If engine does not start, please operate "STARTING A COLD ENGINE" again.

- **TO STOP ENGINE**

Release throttle trigger. Let engine return to idle. Push and hold ignition stop switch until engine stops (Fig. 6).

Trimming Instructions

- **ADDITIONAL SAFETY PRECAUTIONS**

Before operating your unit, review ALL SAFETY PRECAUTIONS in this manual.

⚠ WARNING / CAUTION

- IF UNFAMILIAR WITH TRIMMING techniques, practice the procedures with ENGINE in "OFF" position.
- ALWAYS CLEAR WORK area of debris such as cans, bottles, rocks, etc. Striking objects can cause serious injury to operator or bystanders and also damage equipment. If an object is accidentally hit, immediately TURN ENGINE OFF and examine equipment. Never operate unit with damaged or defective equipment.
- ALWAYS TRIM OR CUT AT HIGH ENGINE SPEEDS. Do not run engine slowly at start or during trimming operations.
- DO NOT use equipment for purposes other than trimming or mowing weeds.
- NEVER raise stringhead above knee height during operation.
- DO NOT operate unit with other people or animals in the immediate vicinity. Allow a minimum of 50 feet (15 meters) between operator and other people and animals when trimming or mowing. Allow a distance of 100 feet (30 meters) between operator and other people and animals when SCALPING with stringhead cutter.
- IF OPERATING UNIT ON A SLOPE, stand below the cutting attachment. DO NOT OPERATE on a slope or hilly incline if there is the slightest chance of slipping or losing your footing.

- **STRINGHEAD LINE RELEASE**

⚠ WARNING: DO NOT use steel wire or plastic-coated steel wire of any kind with your stringhead. Serious operator injury can result.

To release fresh line, run engine at full throttle and "bump" stringhead against lawn. Line will automatically release. The knife in debris shield will trim excess line (Fig. 7A).

⚠ CAUTION: Periodically remove weed wrap to prevent overheating the drive shaft. Weed wrap occurs when strands of weed become entangled around the shaft beneath the debris shield (Fig. 7B). This condition prevents the shaft from being properly cooled. Remove weed wrap with screwdriver or similar

- **TRIMMING PROCEDURES**

When properly equipped with a debris shield and stringhead, your unit will trim unsightly weeds and tall grass in those hard-to-reach areas - along fences, walls, foundations and around trees. It can also be used for scalping to remove vegetation down to the ground for easier preparation of a garden or to clean out a particular area.

NOTE: Even with care, trimming around foundations, brick or stone walls, curves, etc., will result in above normal wear to the line.

TRIMMING / MOWING

Swing trimmer with a sickle-like motion from side to side. Do not tilt the stringhead during the procedure. Test area to be trimmed for proper cutting height. Keep stringhead at same level for even depth of cut (Fig. 8A).

CLOSER TRIMMING

Position trimmer straight ahead with a slight tilt so bottom of stringhead is above ground level and line contact occurs at proper cutting point. Always cut away from operator. Do not pull trimmer in toward operator.

FENCE / FOUNDATION TRIMMING

Approach trimming around chain link fences, picket fences, rock walls and foundations slowly to cut close without whipping string against the barrier. If the line comes in contact with rock, brick walls, or foundations, it will break or fray. If string snags fencing, it will snap off.

GB**TRIMMING AROUND TREES**

Trim around tree trunks with a slow approach so string does not contact bark. Walk around the tree trimming from left to right. Approach grass or weeds with the tip of the line and tilt stringhead slightly forward.

⚠ WARNING: Use extreme caution when SCALPING. Keep a distance of 100 feet (30 meters) between operator, other people and animals during these operations.

SCALPING

Scalping refers to removal of all vegetation down to the ground. To do this, tilt the stringhead to about a 30 degree angle to the left. By adjusting the handle you will have better control during this operation. Do not attempt this procedure if there is any chance flying debris could injure operator, other people or cause damage to property. (Fig. 8B)

• REPLACING CUTTER LINE

1. Turn knob (A) COUNTERCLOCKWISE and remove (Fig. 9A). Use knob spanner supplied.
2. Remove spool (B) and spring (C) from spindle (D).
3. Remove any remaining cutter line (H).
4. Double a 14' (4.3m) length of .080" (2mm) cutter line. Place the looped center in one of the slots of the spool divider (Fig. 9B).
5. Wind cutter line clockwise as shown in illustration (Fig. 9C), keeping tension, with each half separated by the spool divider. Wind to within 6" (15cm) of the ends.

Fig 9A

- A. KNOB
- B. SPOOL
- C. SPRING
- D. SPINDLE
- E. HOUSING
- F. SLOTS
- G. EYELETS
- H. CUTTER LINE

6. Lock each end of line (H) into a slot (F) on opposite sides of the spool (Fig. 9D).
7. Install the spring (C) over the spindle (D). Insert each end of the line through an eyelet (G) in the housing (E) (Fig. 9E).
8. Lower the spool into the housing (E) while feeding the line through the eyelets (G). Ensure the spring seats itself into the spool (Fig. 9E).

9. Once the spool is in place, apply pressure on the spool compressing the spring. Pull each end of the line (H) sharply to unlock the line from the slots (Fig. 9F).
10. Continue to apply pressure to the spool until the knob can be threaded CLOCKWISE onto the spindle. Tighten the knob securely by hand only (Fig. 9G).
11. Trim the excess line to approximately 5" (13cm). This will minimize load on engine during starting and warm-up (Fig. 5A).

• AIR FILTER

⚠ Caution: Remove fuel from unit and store in approved container before starting this procedure. Open fuel cap slowly to release any pressure which may have formed in fuel tank.

To Clean Air Filter: (fig 11a - 11c)

1. Remove 3 screws (A) holding air filter cover in place, pull out choke lever knob (B) remove cover (C) and lift filter (D) from air box.
2. Wash filter in soap and water. **DO NOT USE GASOLINE!**
3. Air dry filter.
4. Reinstall filter.

NOTE: Replace filter if frayed, torn, damaged or unable to be cleaned.

• FUEL CAP / FUEL FILTER

⚠ Caution: Remove fuel from unit and store in approved container before starting this procedure. Open fuel cap slowly to release any pressure which may have formed in fuel tank.

NOTE: Keep vent (A) on fuel cap clean of debris (Fig. 12A).

1. Lift fuel line and filter (B) out of tank. A steel wire (C) with a hook or a paper clip works well (Fig. 12B).
2. Pull off with a twisting motion (Fig. 12C).
3. Replace fuel filter (D).

NOTE: Never operate the trimmer without the fuel filter. Internal engine damage could result!



CARBURETOR ADJUSTMENT

The carburetor was pre-set at the factory for optimum performance. If further adjustments are necessary, please take your unit to the nearest Authorized Service Center.

SPARK PLUG

1. Spark plug gap = .025" (.635mm) (Fig. 13).
2. Torque to 105 to 130 inch pounds (12 to 15 N•m). Connect spark plug boot.

DEBRIS SHIELD KNIFE SHARPENING

1. Remove cutter knife (E) from debris shield (F) (Fig. 14).
2. Place knife in a bench vise. Sharpen knife using a flat file, being careful to maintain the angle of cutting edge. File in one direction only.

STORING A UNIT

Warning: Failure to follow these steps may cause varnish to form in the carburetor and difficult starting or permanent damage following storage.

1. Perform all the general maintenance recommended in the Maintenance Section of your User Manual.

2. Clean exterior of engine, drive shaft assembly, debris shield and stringhead.
3. Drain fuel from the fuel tank.
4. After fuel is drained, start engine.
5. Run engine at idle until unit stops. This will purge the carburetor of fuel.
6. Allow engine to cool (approx. 5 minutes).
7. Using a spark plug wrench, remove the spark plug.
8. Pour 1 teaspoon of clean 2-stroke oil into the combustion chamber. Pull starter rope slowly several times to coat internal components. Replace spark plug.
9. Store unit in a cool, dry place away from any source of ignition such as an oil burner, water heater, etc.

REMOVING A UNIT FROM STORAGE

1. Remove spark plug.
2. Pull starter rope briskly to clear excess oil from combustion chamber.
3. Clean and gap spark plug or install a new spark plug with proper gap.
4. Prepare unit for operation.
5. Fill fuel tank with proper fuel / oil mixture. See Fuel and Lubrication Section.

Trouble shooting the engine

| PROBLEM | PROBABLE CAUSE | CORRECTIVE ACTION |
|--|---|--|
| Unit won't start or starts but will not run. | Incorrect starting procedures. Incorrect carburetor mixture adjustment setting. Fouled spark plug Fuel filter plugged. | Follow instructions in the User Manual. Have carburetor adjusted by an Authorized Service Center. Clean / gap or replace plug. Replace fuel filter. |
| Unit starts, but engine has low power. | Incorrect lever position on choke. Dirty air filter. Incorrect carburetor mixture adjustment setting. | Move to RUN position. Remove, clean and reinstall filter. Have carburetor adjusted by an Authorized Service Center. |
| Engine hesitates. | Incorrect carburetor mixture adjustment setting. | Have carburetor adjusted by an Authorized Service Center. |
| No power under load. | Incorrectly gapped spark plug. | Clean / gap or replace plug. |
| Runs erratically. | | |
| Smokes excessively. | Incorrect carburetor mixture adjustment setting. Incorrect fuel mixture. | Have carburetor adjusted by an Authorized Service Center. Use properly mixed fuel (40:1 mixture). |

ISC GmbH
Eschenstraße 6
D-94405 Landau/Isar

Konformitätserklärung



- D** erklärt folgende Konformität gemäß EU-Richtlinie und Normen für Artikel
- GB** declares conformity with the EU Directive and standards marked below for the article
- F** déclare la conformité suivante selon la directive CE et les normes concernant l'article
- NL** verklaart de volgende conformiteit in overeenstemming met de EU-richtlijn en normen voor het artikel
- E** declara la siguiente conformidad a tenor de la directiva y normas de la UE para el artículo
- P** declara a seguinte conformidade de acordo com a directiva CE e normas para o artigo
- S** förklarar följande överensstämmelse enl. EU-direktiv och standarder för artikeln
- FIN** ilmoittaa seuraavaa Euroopan unionin direktiivien ja normien mukaista yhdenmukaisuutta tuotteelle
- DK** erklærer herved følgende samsvar med EU-direktiv og standarder for artiklet
- RUS** заявляет о соответствии товара следующим директивам и нормам ЕС
- HR** izjavljuje sljedeću uskladenost s odredbama i normama EU za artikl.
- RO** declară următoarea conformitate cu linia directoare CE și normele valabile pentru articolul.
- TR** ürün ile ilgili olarak AB Yönetmelikleri ve Normları gereğince aşağıdaki uygunluk açkılarını sunar.
- GR** δηλώνει την ακόλουθη συμφωνία σύμφωνα με την Οδηγία ΕΕ και τα πρότυπα για το προϊόν
- I** dichiara la seguente conformità secondo la direttiva UE e le norme per l'articolo
- SK** atesterer følgende overensstemmelse i henhold til EU-direktiv og standarder for produkt
- CZ** prohlašuje následující shodu podle směrnice EU a norem pro výrobek.
- H** a következő konformitást jelenti ki a termékerekre vonatkozó EU-irányvonalak és normák szerint
- SL** pojasnjuje sledečo skladnost po smernici EU in normah za artikel.
- PL** deklaruje zgodność wymienionego poniżej artykułu z następującymi normami na podstawie dyrektywy WE.
- SK** vydává nasledujúce prehlásenie o zhode podľa smernice EÚ a noriem pre výrobok.
- RO** declară următoarea conformitate cu linia directoare CE și normele valabile pentru articolul.

Petrol Grass Trimmer SGT 24

- | | |
|--|---|
| <input checked="" type="checkbox"/> 98/37/EG | <input type="checkbox"/> 87/404/EWG |
| <input type="checkbox"/> 73/23/EWG_93/68/EEC | <input type="checkbox"/> R&TTED 1999/5/EG |
| <input type="checkbox"/> 97/23/EG | <input checked="" type="checkbox"/> 2000/14/EG: $L_{WM} = 97 \text{ dB}$; $L_{WA} = 99 \text{ dB}$ $P = 0,8 \text{ kW}$; $\varnothing = 38 \text{ cm}$ |
| <input checked="" type="checkbox"/> 89/336/EWG_93/68/EEC | <input type="checkbox"/> 95/54/EG: |
| <input type="checkbox"/> 90/396/EWG | <input type="checkbox"/> 97/68/EG: |
| <input type="checkbox"/> 89/686/EWG | |

EN ISO 14982: 1998; EN ISO 11806: 1997; KBV V

Landau/Isar, den 09.11.2004

Brunhözl

Brunhözl
Leiter Produkt-Management

Landauer

Landauer
Produkt-Management

Art.-Nr.: 34.016.87 I.-Nr.: 01014 Archivierung: 3401688-42-4160270-M
Subject to change without notice

GARANTIEURKUNDE

Auf das in der Anleitung bezeichnete Gerät geben wir 2 Jahre Garantie, für den Fall, dass unser Produkt mangelhaft sein sollte. Die 2-Jahres-Frist beginnt mit dem Gefahrenübergang oder der Übernahme des Gerätes durch den Kunden. Voraussetzung für die Geltendmachung der Garantie ist eine ordnungsgemäße Wartung entsprechend der Bedienungsanleitung sowie die bestimmungsgemäße Benutzung unseres Gerätes.

Selbstverständlich bleiben Ihnen die gesetzlichen Gewährleistungsrechte innerhalb dieser 2 Jahre erhalten. Die Garantie gilt für den Bereich der Bundesrepublik Deutschland oder der jeweiligen Länder des regionalen Hauptvertriebspartners als Ergänzung der lokal gültigen gesetzlichen Vorschriften. Bitte beachten Sie Ihren Ansprechpartner des regional zuständigen Kundendienstes oder die unten aufgeführte Serviceadresse.

Sovereign Customer Helpline 0044 (0) 151 649 1500

Contact for Warranty repairs: HSS plc Tel: 0845 728 2828

WARRANTY CERTIFICATE

The product described in these instructions comes with a 2 year warranty covering defects. This 2-year warranty period begins with the passing of risk or when the customer receives the product. Please retain receipt as proof of purchase.

For warranty claims to be accepted, the product has to receive the correct maintenance and be put to the proper use as described in the operating instructions.

Your statutory rights of warranty are naturally unaffected during these 2 years.

This warranty applies in Germany, or in the respective country of the manufacturer's main regional sales partner, as a supplement to local regulations. Please note the details for contacting the customer service center responsible for your region or the service address listed below.

GB

The reprinting or reproduction by any other means, in whole or in part, of documentation and papers accompanying products is permitted only with the express consent of ISC GmbH.

Technical specifications subject to change

EH 11/2004