

GB **Operating Instructions for the
Indoor and Outdoor Device**

PRO KLIMA
Klimageräte

Split-system Air Conditioner



Important note:

This high-quality product will only offer optimum service if installed correctly and in the right place, and is put into operation for the first time by a suitably competent person. Avoid malfunctions by seeking competent advice from an expert with regards to the location, installation and starting up of the system.

We shall accept no liability for malfunctions or inadequate cooling performance resulting from the improper handling of the product.

The socket-outlet required to supply power must be connected and commissioned by a specialist contractor.

If the system is to be moved to another location or disposed of, only a suitably qualified electrician's/cooling system firm is permitted to undertake any work of disassembly or disposal.



Art.-Nr.: 23.657.12

I.-Nr. 01016

SPLIT 900 EQ C+H

Technical data:	
Cooling capacity*	2500 watts
Heating capacity*	2850 watts
Energy efficiency*	B (EER 3.01/COP 3.43)
Air capacity	420 m ³ /h
Absorbed humidity	1.0 l/h
Timer	24 h
Operating voltage	230/50 V ~ Hz
Nominal power consumption, cooling	930 watts
Nominal current consumption, cooling	4.2 A
Nominal power consumption, heating	930 watts
Nominal current consumption, heating	4.2 A
Compressor	Rotary piston
Starting current	19 A
Outdoor temperature, cooling operation °C	+21 - +43 (DB)
Outdoor temperature, heating operation °C	7 - +24 (DB)
Length of refrigerant line supplied	4 m
Length of refrigerant line, max.	4 m
Refrigerant	R 407 C
Refrigerant filling capacity	750 g
Sound pressure level	
Inside	≤ 38 dB (A)
Outside	≤ 53 dB (A)
Dimensions	
Inside	80 x 25 x 16 cm
Outside	83 x 54,5 x 25,5 cm
Weight	
Inside	8 kg
Outside	32 kg
* data in accordance with EN 14511	

<p>Sleep function: Computer-controlled simulation of the physiological sleeping curve of the human body for a quiet and comfortable sleeping climate.</p>	<p>24-hour program setting: Precise time setting. The switch-over time and switching on time can be set to any desired time within 24 hours.</p>	<p>Automatic adjustment of the air velocity: Automatic adjustment of the air capacity to a high, medium or low air velocity, depending on the difference between the set temperature and the room temperature.</p>
<p>Function for moving air flow: Vertical movement of the air flow up and down to prevent local over-cooling and to save energy costs. This effect, which reflects the natural behaviour of wind, is found to be very pleasant by the human body.</p>	<p>Automatic function for cool/warm air: In this automatic mode the air is emitted horizontally in the cooling function and downwards in the heating function.</p>	<p>Blower function with adjustable angle: You can select one of five different options, depending on the shape of the room and the your particular position in the room.</p>
<p>Thermo start system: When switched on, no cold air is blown out.</p>	<p>Independent dehumidifying function: Computer-controlled dehumidifying function without changing the room temperature.</p>	<p>Self-diagnosis function: The TIMER and RUN indicator lamps flash in the event of a malfunction in the indoor device. Includes an indication of the type and location of the malfunction.</p>
<p>Controls for constant fan motor speed: The fan motor for the indoor device always rotates at a constant speed, even if the voltage fluctuates considerably (between 187V - 253V). It therefore guarantees a stable air flow and speed.</p>	<p>Disk piston blower: The latest generation of disk blowers are low-vibration devices, quiet, long lasting, energy-efficient and cost-effective.</p>	<p>Microprocessor controls: A microprocessor with state-of-the-art technology for simple handling in time-setting mode for a guaranteed lasting stable room temperature.</p>

Safety instructions

- Read the safety instructions before you start to use the device.
- These points set out extremely important precautionary measures that you must comply with.
- Keep the Operating Instructions in a safe place once you have read them.
- Check that the drainage line is correctly connected. If not, water will escape.
- **Warning!**
Do not extend the cable and never use multiple plugs. A poor electrical connection, poor insulation or voltage which is higher than permitted can cause fire.
- **Remove all dirt from the power plug and plug it in firmly. Soiled plugs can cause fire or an electric shock.**
- **Warning!**
- Never pull out the plug while the device is in use.
- Never permit cool air to be blown directly at you for any lengthy period of time.
- In the event of any abnormalities (e.g. smell of burning), immediately switch off the device and pull the plug. Contact your service partner.
- Never poke fingers or sticks in the air inlet and outlet vents.
- Never attempt to repair the air conditioner yourself. Always contact your service partner if it requires repair.
- Never pull the plug out by pulling on the cable. Hold the plug firmly and pull it out of the plug socket, otherwise there is a risk of damaging the cable.
- Always switch off the device and pull the plug before you start to clean it.
- Never actuate any switches with wet hands.
- Never clean the air conditioner with water.
- Never place any plants or animals under a location to which cool air flows as this could have an undesirable affect on them.
- Never use combustible cleaning agents as these could cause a fire or deformation.
- If the air conditioner is to be used in conjunction with other heaters, the air should be refreshed periodically, otherwise there is a risk of lack of oxygen.
- Never use the device for any other purpose than the intended use. Never place food, precision instruments, plants, animals, paint, etc. on the device.
- Never hold any burning objects close to the device if they could be directly affected by the emitted air.
- Always pull out the power plug if the device is not going to be used for any lengthy period of time. Collections of dust can cause fire.
- Never step onto the outdoor device and never place anything on it.
- Never use an unsteady or rusty base.
- Never allow the device to run for too long with the doors or windows open, or if the humidity is very high. If the air conditioner runs for a long time in cooling mode and the humidity is high (over 80%), condensed water may drip out of the device.
- Never stand on an unsteady base when you remove the device from the holder on the wall.
- Check that the condensation water can run off unhindered. Water damage can result if the condensation water cannot run off properly.
- Never touch any metal parts on the indoor device when removing the air filter. You may injure yourself.
- Never install the device in a room in which combustible gases can be emitted. Emitted gases may collect and cause an explosion.
- Always switch off the device and pull out the power plug during a storm. Electrical parts may get damaged.
- Leave the electrical installation of the 230 V socket-outlet for the system to an authorized electrical contractor. Incorrect installation can lead to injury or damage to property.
- For electrical safety purposes we recommend that you install an earth-leakage circuit-breaker.
- If you are not confident in being able to assemble the system, ask our customer service team or a refrigeration contractor of your choice to do the refrigeration part of the installation work. Incorrect installation can lead to injury or damage to property.
- Ask a service partner or specialist cooling system firm to undertake all work of cooling system-related installation.
- Incorrect installation may cause injury or damage to the device.

Description of parts:

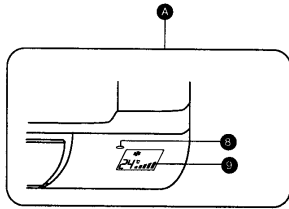

- 1 Air intake flap
- 3 Air filter
- 4 Emergency switch
- 5 Remote control
- 6 Slats
- 7 Water hose
- 8 Receiver for remote control
- 9 Display
- 10 Power cable
- 11 Air outlet grille



Important!
The indoor device must be correctly connected to the outdoor device. There is a risk of damage to the device if installed incorrectly.

Indoor device

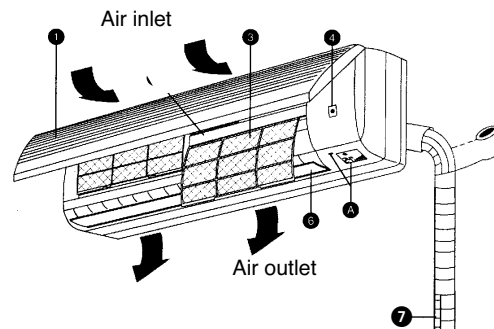

Outdoor device

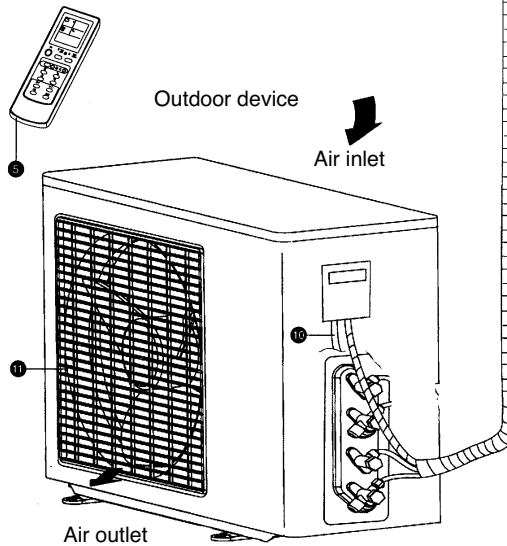

Display: Indoor device

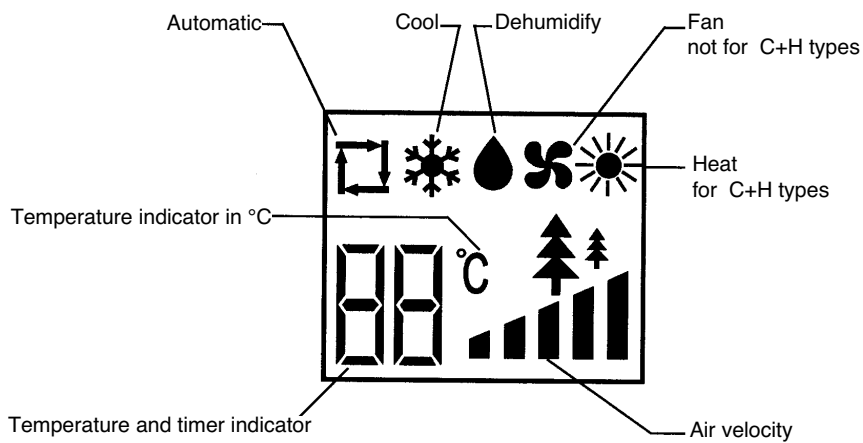

Open



Press the two bottom corners (marked with Push) on the intake grille. The grille swings open (approx. 25°) and stays in this position.

Note: Never attempt to open the grille by more than 70° as this may damage it.

close

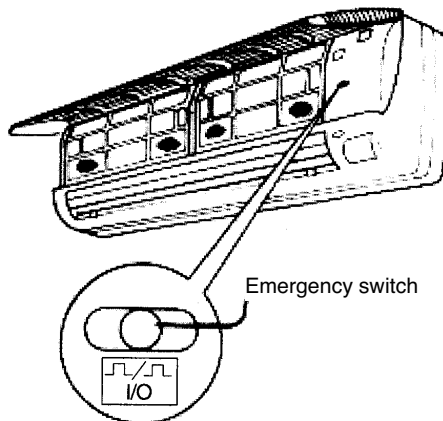

This switch can be used as an emergency switch to switch the system on and off if the remote control fails to work.

● Remote controll:

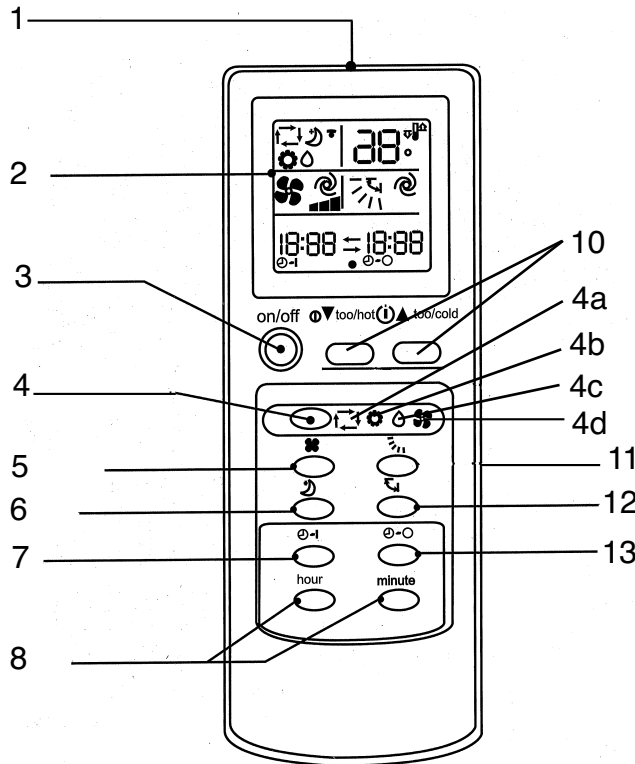

- 1 Signal output window
- 2 Function display
- 3 On/Off switch
- 4 Function switch (mode switch)
 - 4a Automatic function
 - 4b Cool
 - 4c Dehumidify (Dry)
 - 4d Heat
- 5 Switch for air circulation velocity
- 6 Sleep selection key
- 7 Timer-on key
- 8 Hours selection switch, minute setting, time setting
- 9 Clock setting
- 10 Temperature adjustment key
- 11 Key for setting the air flow angle
- 12 Full blast key
- 13 Timer-off key
- 14 Reset key
- 15 Battery cover opener

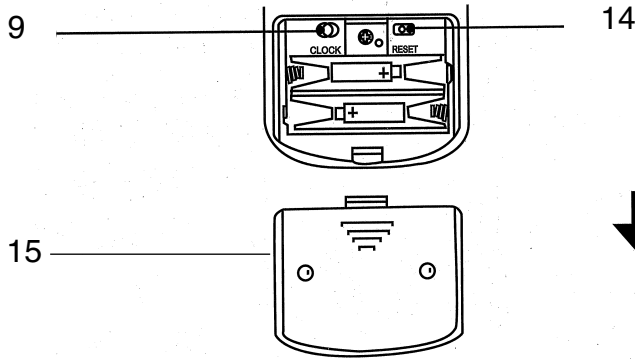

Preparing to use the remote control for the first time and setting the current time.

1

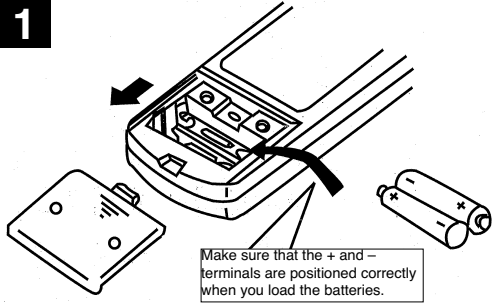

Make sure that the + and - terminals are positioned correctly when you load the batteries.

Open the rear cover and insert the batteries.

2

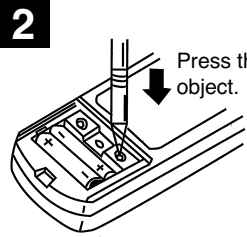

Press the reset key with a pointed object.

Always press the reset key once after every battery change.
Do not forget to do so, otherwise normal operation will not be possible.

3

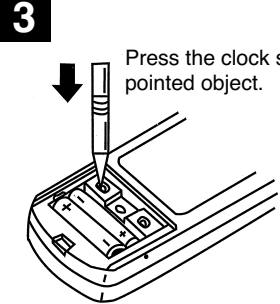

Press the clock setting key with a pointed object.

4

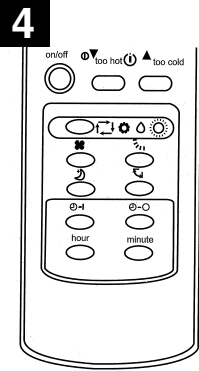

Press the hours/minutes with the time setting key and set the right time.
Press the hours key and set the hours.
Press the minutes key and set the minutes.
(Please take AM=24.00-12.00 or PM=12.00-24.00 into account!)

5

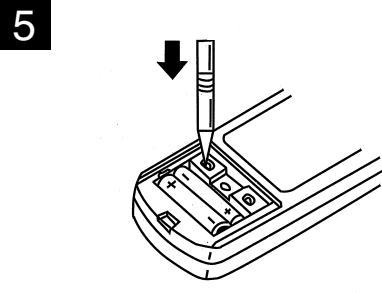

Now press the clock setting key again and replace the cover on the back.

Preparation for use of the remote control

- The radio signal has a range of approx. 6 m.
- When the ON/OFF button is pressed, the indoor device will emit an audio signal once or twice to indicate that the device has received the signal.
- If you do not hear a signal, press again.
- Handle the remote control with care and, in order to avoid malfunctions, never drop it or leave it in a damp location. Attach the remote control to the wall in such a way that the receiver on the indoor device can receive the remote control signal effectively.

Changing the batteries!

- If the signal on the remote control becomes weak or the indicator on the remote control becomes difficult to read, replace the batteries **immediately**.
- It is important that the + and – terminals on the batteries are correctly positioned in the remote control.
- Both batteries should always be new and of the same make.

Remote control fails to work (emergency operation)

If the remote control fails to work (empty batteries or malfunction), use the emergency switch.

- Press the emergency switch several times and the device switches off.

Note:

For the first 30 minutes the temperature adjustment does not yet function. The device runs in continuous mode and at the fastest fan speed.

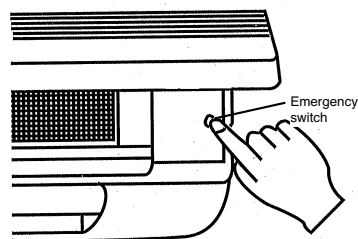

- The device is on: The device switches off if the emergency switch is pressed.
- The device is in setup or clock off mode: The device switches to standby if the emergency switch is pressed.



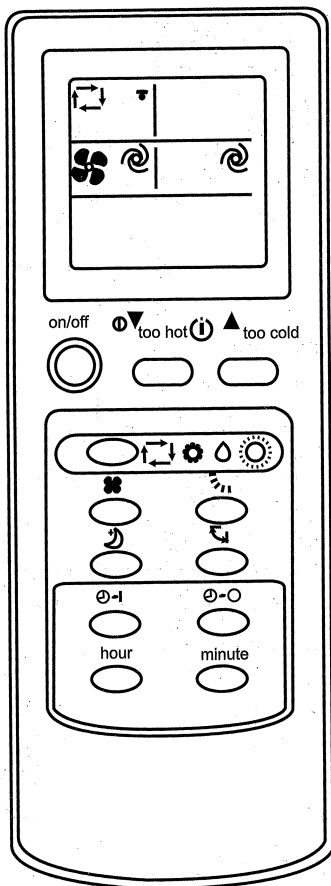

"I feel ..." automatic function

A light press of the automatic function "I feel" can produce a comfortable room temperature.



To start
 Press the **ON/OFF KEY** 
 If  automatic function is indicated, the air conditioner switches to a comfortable room temperature.

To stop,
 Press the **ON/OFF KEY** 
 15 minutes after switching off, you may feel that it is possibly a little too hot. To reduce the temperature a little, press the key  (too hot). Each press of the key will reduce the temperature by 1° C.
 If it is too cold, increase the temperature with the key  (too cool). Each press of the key will increase the temperature by 1° C.

LCD display for the indoor

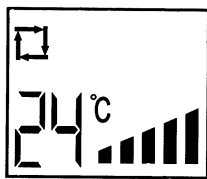

Low/high indicator

If the automatic function is not shown, press key "4" as often as is required for the automatic function (4a) to be shown.

Each time the key is pressed the sequence changes: Automatic (4a) - Cool (4b) - Dehumidify (Dry) (4c) - Heat (4d).

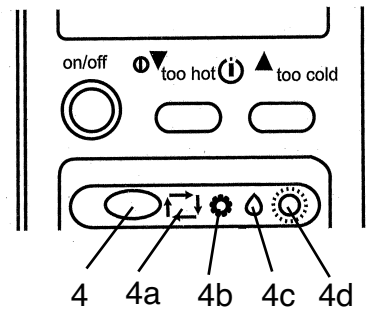

Structure of the automatic function

Operation functions.

When the automatic function is started, the mode of operation for the room temperature adjusts to the corresponding function such as cool, dehumidify, etc. If operation is stopped for 2 hours, it begins again with the same function setting that it had before it stopped. Once the corresponding function has become set, it will no longer be affected by the room temperature, even if it changes. If you do not wish to use this function, press the key in order to set one of the following functions.

Automatic function once the room temperature has been checked.

Room temperature at start temperature

Above +25°C
+21-25°C
Below 21°C

Function

Cool
Ventilate / Dehumidify
Heat

Set-point

approx. 24°C

approx. 24°C



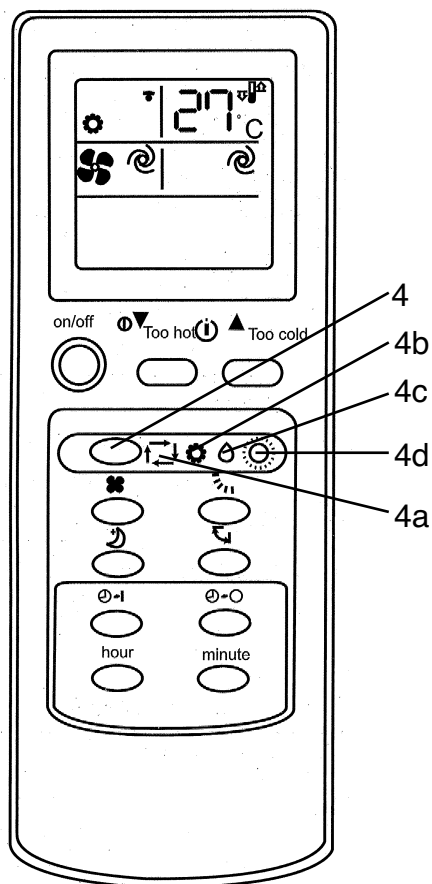

Note:

The heat function can be used for outdoor temperatures down to +7°C. Heating is not possible if the outdoor temperature is any lower.

Selecting the mode function (cool (4b), dehumidify (4c), heat (4d)). Select Mode in order to finely adjust the room temperature or air flow.



Important!
If the ambient temperature is too high the cooling system works at maximum capacity.

To select cool, dehumidify or heat:
1 Press the ON/OFF key. 
2 Press    to select the corresponding function.
Every time you press the key the function changes in the following sequence: Automatic - Cool - Dehumidify - Heat

If you wish to switch off the device:
Press the ON/OFF key. 
Once the device has been set for the first time, all you have to do to return to the previous function is press the ON key.

Heat function:
Select the heat function with key 4. 
The heat function can be used at any time as long as the outdoor temperature is above approx. +7°C. The maximum room temperature to be reached depends on the outdoor temperature and the nature of the particular building.
Note: If during operation the room temperature is more than 2°C above (cool) or less than 2°C below (heat) the set-point temperature, the set-point temperature on the air conditioner cannot be changed. As soon as the temperature difference between the room temperature and the predefined set-point temperature is less than 2°C again, it will be possible to change the set-point temperature on the air conditioner again.
The lower the outdoor temperature, the lower the room temperature that can be achieved with the heater function.

Changing the temperature

Press the “too hot” key  to reduce the temperature. Each press of the key reduces the set temperature by 1°C.

Press the “too cool” key  to increase the temperature. Each press of the key increases the temperature by 1°C.

The system can become overloaded if the air conditioner draws too much heat from the air. The fan on the outdoor device stops automatically, thanks to the microprocessor controller, to protect the air conditioner. If the fan on the outdoor device stops, the outdoor device will indicate frost. This is not a fault or malfunction.

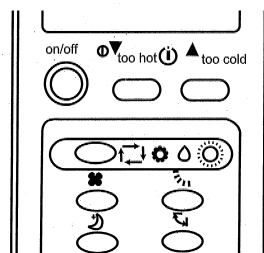

Dehumidifying mode

If the temperature is set to the automatic function, this function cannot be changed.

Selecting the function (cool, dehumidify).

Monitoring during operation:

1. In order to increase the cooling effect, close the windows and lower the roller blinds or reduce incoming sunlight.
2. Lower the venetian blinds in order to reduce incoming sunlight.
3. Install the outdoor device in a suitable place away from direct sunlight, where it will save energy.

Dehumidifying

70% air humidity is the upper limit with which the human body feels comfortable.

If it is too warm for the human body this means the water content is too high, i.e. humidity is too high. Humidity has a certain relationship to temperature. As a general rule, the following applies: 60-70% for the summer and 50-70% for the winter.

Adjusting the air velocity and air flow

Select the air flow and air circulation with which you feel most comfortable.

Select a high setting ■■■ if you wish to cool the entire room. Select the sleep function when you want to sleep and wish to reduce the noise level while sleeping.

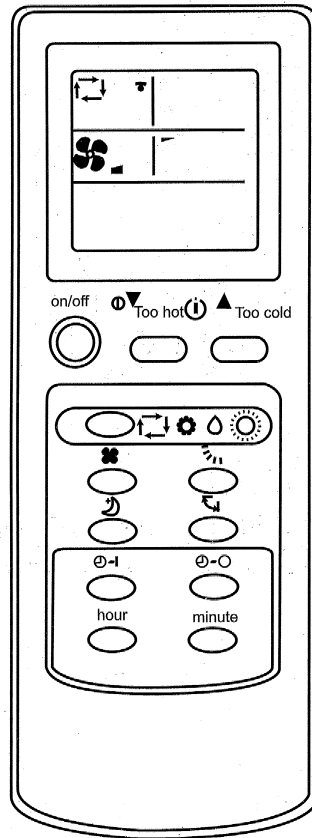

Press the  key to adjust the air velocity. Each press of the key changes the air velocity as follows: Low, moderate, high, automatic.

Press the  key to adjust the direction of the air up/down. Each press of the key changes the direction.

Recommended range for the air flow up/down. Adjust with the automatic key. Select cool, heat or dehumidify.

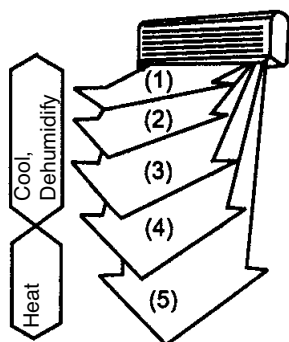

Adjusting the air velocity and direction of flow

Automatic air flow

Press the  key, change the air flow to automatic and the optimum slat position will be selected for efficient effect.

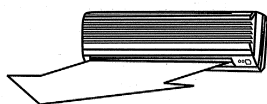

Cool + Dehumidify

In cool and dehumidify the air flows out horizontally.

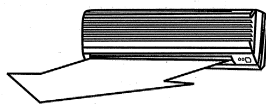

Heat

If the air temperature is cool, the air flows out horizontally.

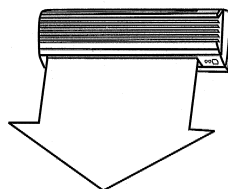

If the air is warm, the air flows out in a downward direction.

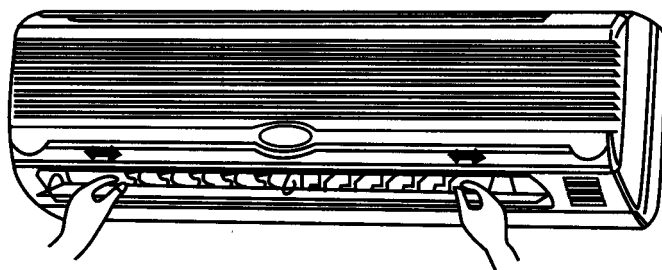



The left-hand and right-hand side flow directions can be adjusted manually.

Perform these adjustments before you start the device because once it has been started the slats vibrate and there is a risk of your fingers getting caught.

Comfortable sleep mode function

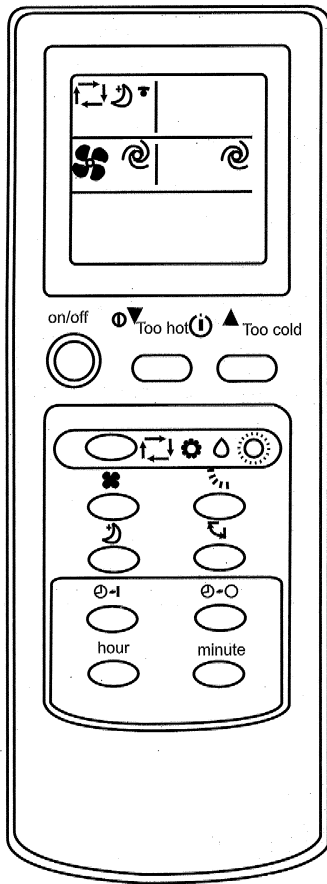
Set this function if you desire a quiet room while sleeping.



Proceed as follows:
Press the  key.
This function is for a quiet room while sleeping.

To cancel this function: Press the key  again.

Important:
Start this function just before you go to sleep. If you start it during the day it is possible that the ambient temperature will become too hot, because the cooling function is reduced.

Full blast

If this function is started, every part of the room will be cooled.

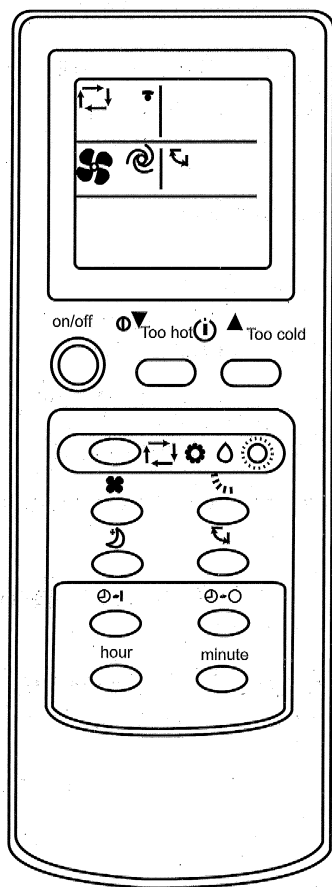

Proceed as follows:
Press the  key.

The cancel:
Press the  key again.

Press the  key during full blast to stop the operation. Once the full blast function has been started the cool air will reach every corner of the room.

Timer mode (ON/OFF)

Set the TIMER mode before going to sleep, or for the normal time that you come home or get up in the morning.

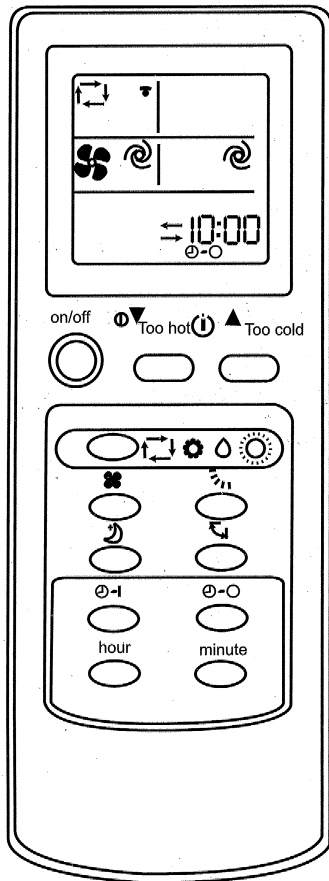

Timer On setting

- 1 Press the \odot key during operation to set the timer to "ON". Each press of the key changes the sequence Start time > Cancel.
- 2 Press the hours/minutes key \odot \odot to set the current time. Each press changes the time by 1 hour or 10 minutes. (AM=24.00-12.00; PM=12.00-24.00)

To cancel
Press the \odot key to cancel the timer setting.

Timer Off setting

- 1 Press the \odot key during operation to set the timer to OFF. Each press of the key changes the sequence > Timer "OFF" switch off.
- 2 Press the hours and minutes key \odot \odot to set the Timer OFF to the right time. Each press changes the time by 1 hour or 10 minutes.

Switching off

Press the key \odot to switch off the timer.

Important note:

- Timer ON and Timer OFF can be combined, with the setting time which is closest to the actual time having priority. (— — means Timer OFF, or Timer ON follows).
- If the clock setting on the remote control has not been correctly set, this will result in an incorrect setting on the timer as well.

Important:

Always switch off the device and pull the power plug before cleaning. The high speed of the fans can cause injury.

Clean the indoor device with a soft cloth only.

Never use petrol, thinners, scouring powder, cleaners, etc., as these may cause damage to the device.

Tips on care

1. Clean the air filter and insert back in the original position.
2. Make sure that all inlets and outlets on the indoor and outdoor device are kept clear and are not covered or blocked.

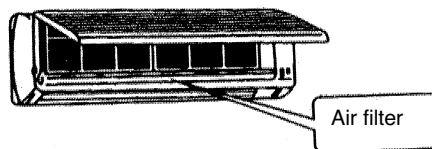

Care precautions

Before cleaning:

Always pull out the power plug.

Care precautions

If the air conditioner is not going to be used for some period of time:

1. Let the fans run for 3 - 4 hours to allow the device to completely dry out. Set the highest possible temperature level while the fans are running.
2. Switch off the device and pull the power plug.

Important:

Always pull out the power plug if the device is not going to be used for some time. Collections of dust pose a fire hazard.

3. Take the batteries out of the remote control.

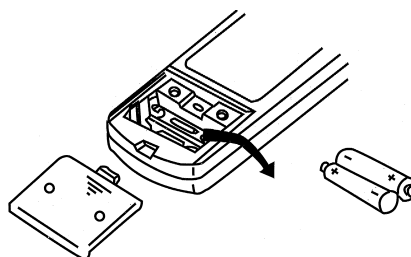

Troubleshooting

Before you ever contact customer services, check the following:

Device does not start. Check the following:

1. Is voltage present at the plug socket outlet?
2. Check the plug fuse!
3. Is the timer set?

The device does not provide satisfactory cooling!

Check the following:

1. Has an appropriate temperature been set?
2. Is the air filter soiled? Clean and fit back in place.
3. Are the inlets and outlets on the outdoor device blocked?
4. Has the sleep mode been set during the day?
5. Are the connections between the indoor and outdoor device adequately sealed? There may not be enough coolant? If so, please contact your service company.

The remote control does not work!

(Important! It only works within a range of 6 m from the indoor device.)

1. Are the batteries still OK? Replace if necessary!
2. Have the batteries been inserted correctly? Check that the + and – terminals are correct!

In the event of a power failure, check the following:

Press the ON/OFF key after a power failure.

If the problems remain after checking through the above points, switch off the device and contact your service company.

Troubleshooting

Problem

Cause

After pressing the start key the device is not started by the microprocessor for 3 minutes.

This is not a fault, it is for the protection of the compressor. Please have a little patience.

Crackling noises can be heard.

This is not a fault.
These tension noises are caused by the contraction and expansion of the front panel in response to temperature differences.

There is an odd smell in the room.

This is not a fault.
The air conditioner also circulates the transpiration from the walls, carpets, smoke, furniture and clothing in the air.

The fan stops during dehumidifying.

This is not a fault.
The temperature increases when water evaporates on the heat exchanger in the indoor device.

You can hear moving water.

This is not a fault.
The coolant in the air conditioner may have expanded.

The air flow changes automatically during operation.

This is not a fault.
The ventilation slats turn to a horizontal position to prevent dripping if the air has been blown downwards for approx. 1 hour in the cool or dehumidifying function. If the blast air is too cool, it will also be blown out horizontally.

There is a clicking noise inside the indoor device.

This is not a fault.
This will normally be the noise of the fan or the compressor when switching on or off.

There is a muffled noise coming from the indoor device.

This is not a fault.
This noise comes from the coolant in the air conditioner.

Water drops from the outdoor device.

This is not a fault.
During the cooling process the tube or the connection pieces cool down in order to form the condensate. During defrosting or heating the evaporation condensate may drip. During heating, water may drip from the heat exchanger.

Air is not blown out immediately in heat mode.

This is not a fault.
Air only starts to be blown out once it has been heated up.

The air conditioner switches off during heat mode.

The outdoor device freezes if the outdoor temperature is low (below approx. +7°C). Heat mode is not possible if the outdoor temperature is below approx. +7°C.

Important installation instructions

Selecting the place to install the indoor device

- The air flow must never be blocked.
- The cooled air should be capable of being distributed to all parts of the room.
- The maximum distance between the indoor and outdoor device must not exceed 4 m.
- Mount on a solid wall to prevent vibrations.
- Avoid direct sunlight.
- Take into account a slight condensate run-off.

Selecting the place to install the outdoor device

- The device must not be exposed to strong gusts of wind.
- Make sure that the device is well ventilated and kept free of dust. Avoid direct exposure to rain and sunlight.
- Make sure that the operational noises and air emissions do not cause a nuisance for neighbours.
- Install on a firm base, avoiding excessive noise or vibrations.
- Avoid locations where combustible gas or leakage can be emitted.
- Fix the device's installation feet with care if the device is to be installed well above them.

Important

Do not hesitate to contact our service partners. They will be able to give you a speedy response to all your questions so that your system can be installed correctly.

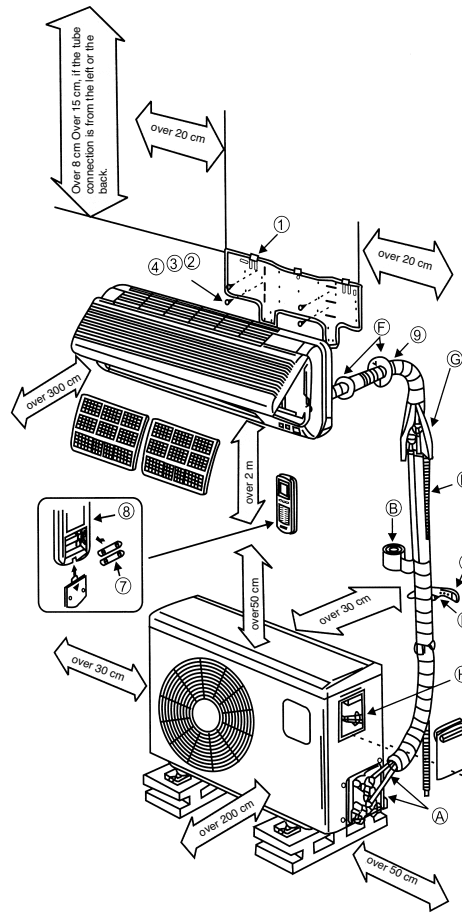

Installation instructions:

Check that the actual mains voltage is the same as the mains voltage specified on the rating plate.

- The device must have separate protection against short-circuits.
- Leave the electrical installation work (230 V socket-outlet) to a specialist contractor.
- Have all the refrigeration installation work performed by a specialist contractor if you are not confident of doing this yourself.
- Incorrect installation can lead to injury or damage to property.
- Always wear ear muffs, goggles and work gloves when performing work of installation.

Notes on electrical connection!

All electrical connection work must be performed by a qualified electrician authorized to do so such work by the applicable electricity supply company. The system must have separate protection against short-circuits. Select a suitably large cable cross-section. The yellow/green wire is to be used as a protective conductor only and under no circumstances as a voltage carrying conductor. The fixed electrical connection of the device must be capable of being isolated from the mains power supply by a device with an isolating distance of at least 3mm (e.g. circuit-breaker). Connect the electrical connections of the indoor and outdoor devices together first and then connect to the mains power supply. Check first that the entire system is voltage-free. Secure the system from being switched on again.

1. Selecting the place of installation

Indoor device

1. The openings for the inlet and outlet air must never be covered, otherwise the air will not be distributed throughout the entire room.
2. Install the indoor device in a location which ensures that the distance through the wall to the outdoor device is as short as possible.
3. Make sure that the drainage hose does not have any kinks or upward inclines when you connect it with the outside.
4. Do not select a location adjacent to a source of heat, high humidity or inflammable gas.
5. Select a location which is firm enough for installation so that the device is not subjected to vibrations.
6. Check that the device has been installed

correctly and exactly.

7. Make sure that there is sufficient space available for later repair and service work.
8. The device should be installed at a distance of at least 1 m from all other electrical devices and installations, e.g. TV, radio, computer, etc.
9. Select a location for the device which is easily accessible so that the filter can be cleaned or replaced without difficulty.

Outdoor device

1. Select a location which avoids causing a nuisance to neighbours from noise and air emissions from device.
2. Select a location which is sufficiently well ventilated.
3. Never cover the air inlets and outlets.
4. The location must be sufficiently firm for installation and the prevention of vibrations.
5. There must be no risk presented by combustible gas or gas escaping as a result of corrosion.
6. Check that the device is installed in accordance with regulations.

Important:

The following could cause malfunctions. Check with your service company in order to prevent possible malfunctions at a later date.

The following locations should be avoided for installation:

- A location where oil (machine oil) is stored.
- A location where there is a high salt content.
- A location with numerous sulphurous sources, e.g. spa zones.
- A location where radio transmitters or amplifier aeriels, welding equipment or medical equipment are in use.
- A location where the outdoor device is exposed to direct sunlight. If necessary the device must be protected with a sun-shade. Such a sun-shade must not interfere with the air flow, however.
- A location in the vicinity of heat or steam generators.
- A location which is heavily exposed to dust.
- A location to which the general public have access.
- A location with any other unusual characteristics.

Important!

- The direction in which the air is blown should correspond with the prevailing direction of the wind.

- Never install in locations exposed to aggressive air.
- Comply with all specified minimum distances (see Important notes on installation).
- The indoor and outdoor devices must only ever be installed in a vertical position.

2. Installation accessories

Before you start to install the devices, please check that all the installation accessories have been supplied.

Item	Designation	Quantity
1	Mounting plate	1
2	Screw 4x30	6
3	Wall hole cap (half)	2
4	Wall hole tube	1
5	Plastic clamp	2
6	Remote control with holder	1
7	Battery, Micro LR03, 1.5V	2
8	Holder for drainage water hose	1

3. Installing the indoor device

It is imperative that you comply with the installation instructions.

3.1 Before you start installation

- Select the location for the indoor device (follow the previous notes on selecting the location for installation).
- Check that the available mains voltage is the same as the voltage specified on the rating plate.
- Fit appropriate insulation, supplied by the customer, to the coolant tubes.

3.2 Fitting the mounting plate

- The mounting plate for the indoor device must be fitted horizontally to the wall. In doing so, it is imperative that you comply with all specified distances. Mark and drill the holes for fastening the mounting plate, and then firmly fasten with dowels and screws. In order to prevent vibrations on the indoor device, make sure that there are no gaps between the wall and the mounting plate.

3.3 Drilling the hole through the wall

- Drill the hole through the wall for the lines/hoses using a 65mm drill bit, drilling from the inside to the outside at an angle downwards of approx. 5°. Then insert the wall hole tube in the hole in the wall.

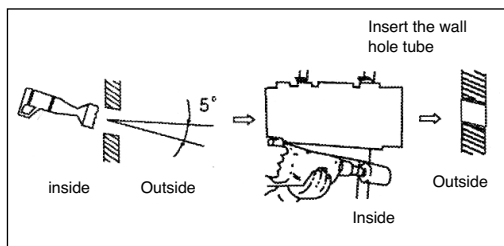

3.4 Fitting the condensation water drainage hose

- The drainage water hose must be run to the outside with a drop. It is imperative that there are no bends or kinks. The end of the drainage hose must not be situated in a container of any kind in which water can collect. Any water held back in the drainage water hose could lead to water damage.
- Slide the additional drainage hose onto the mounts on the drainage hose already fixed to the indoor device. Fasten this connection point with adhesive tape, checking that it is fully sealed as you do so. Wrap the section of the drainage hose in the hole in the wall, plus approx. 10 cm in front of the wall on both the inside and outside, in insulation material.

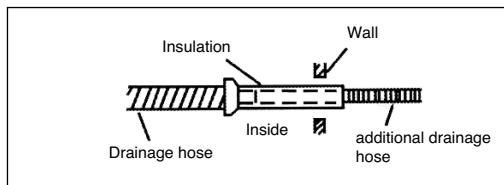

3.5 Wrapping the lines/hoses in protective tape

- Please note that the power cable is not to be fed through to the outside. All tubes, electric cables and the drainage water hose have to be wrapped with the supplied protective tape. Depending on whether the lines are right-hand or left-hand versions, the corresponding bushing preparations must be removed from the indoor device.

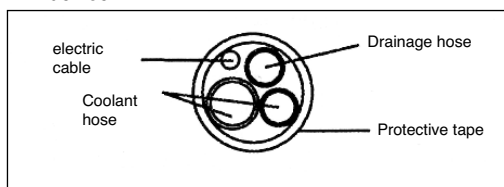

3.6 Final installation of the indoor device

- Feed the package of lines/hoses through the hole in the wall.

- Fit the indoor device to the hook at the top of the mounting plate and let it lock into place at the bottom.
- The package of lines/hoses is to be laid between the housing of the indoor device and the wall. In order to prevent condensation water, insulate the package of lines/hoses with heat insulation material.
- Fit the two halves of the inside wall hole cap to the wall hole tube.

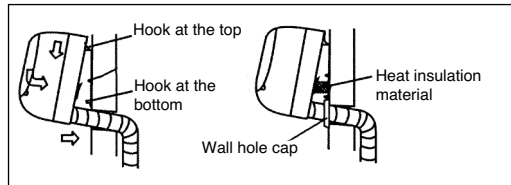

4. Installing the outdoor device

It is imperative that you follow the installation instructions.

4.1 Before you start installation

- Select the location for installation (follow the previous notes on selecting the location).
- Check that the available mains voltage is the same as the voltage specified on the rating plate.
- The maximum distance between the indoor and the outdoor device is restricted by the length of the coolant tube, which is a maximum of 4m. It is NOT possible to extend the coolant tube.
- If the outdoor device is higher than the indoor device, make sure that a curve is made in the coolant tube which is lower than the bottom edge of the indoor device.
- Fasten the condensation water drain to the base of the outdoor device.

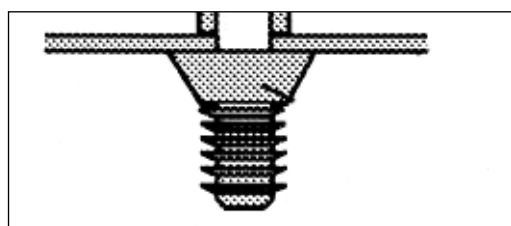
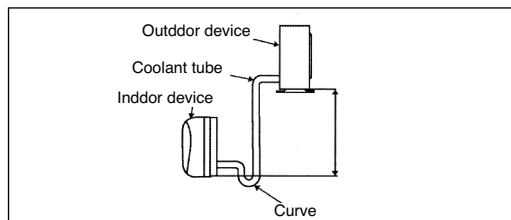

4.2 Mounting the outdoor device

- The outdoor device can be fastened to the ground or to a wall bracket (e.g. special accessory Art. No. 23.651.56) with dowels and screws. To do so, use the holes on the device.

5. Connecting the refrigerant lines

5.1 Important information

-You will require the following tools to carry out this installation work correctly:

- 1x open-ended spanner, 19 mm
- 1x open-ended spanner, 22 mm
- 1x open-ended spanner, 24 mm
- 1x Allen key, 5 mm
- 1x Philips screwdriver
- 1x leak detection spray or alternatively soap suds (water / detergent mix)

- Follow the detailed instructions for connecting the refrigerant lines to the letter. We can only provide a warranty if the lines are installed correctly as described in the instructions.
- Kinked and/or damaged lines and connectors can only be accepted under the warranty if a claim is made for them before the installation work is carried out.
- **Do not remove the sealing caps and stoppers until immediately before you install the lines.**
- To prevent leaks, ensure that the quick-release screw connections are absolutely free of dirt. Moisture or foreign bodies will adversely affect the function of the quick-release connectors, leading to a risk of refrigerant loss (not covered by the warranty).
- Only install refrigerant lines outdoors in dry weather.
- The refrigerant lines must not be installed and then plastered over.
- Please make sure that refrigerant is never allowed to enter the environment.
- Improper handling of refrigerant may be harmful to health. Always wear work gloves and goggles when handling refrigerant.
- The equipment designed for outdoor use may only be installed outdoors. Provide good ventilation.
- Do not smoke during the installation work.
- The equipment must never be operated without the refrigerant lines connected, otherwise the equipment will be damaged immediately.
- The screw connections may only be tightened using the appropriate open-ended spanner. Remember that if they are tightened with too little torque they will leak but if they are tightened with

too much torque the screw connections may suffer damage. If you should not be confident about connecting the refrigerant line connectors yourself, it is imperative that you contact your customer service team or a refrigeration contractor.

- **Important!** The EQ valves are only designed for one-time installation. Their seal cannot be guaranteed if they are installed on more than one occasion. This will also void the warranty.

5.2 Connecting the refrigerant line

1. Remove the connection cover on the outdoor equipment.

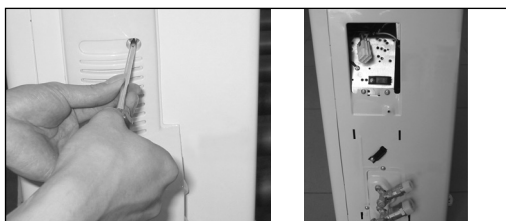

2. Do not remove the plastic seals from the outdoor equipment and the appropriate refrigerant line until immediately before you connect them.

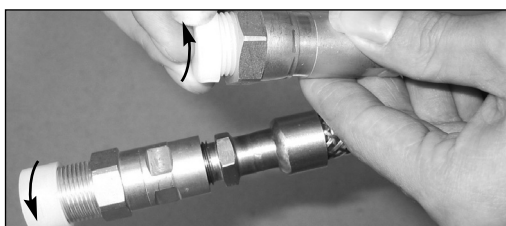
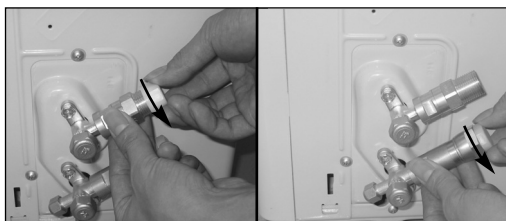

3. Align the refrigerant lines correctly so that they line up with the valves and are not stressed. Place the screw connector on the refrigerant line just on to the thread on the outdoor equipment and tighten the first few threads by hand.

Note: The refrigerant lines must be connected to the valves on the outdoor equipment with as little stress as possible.

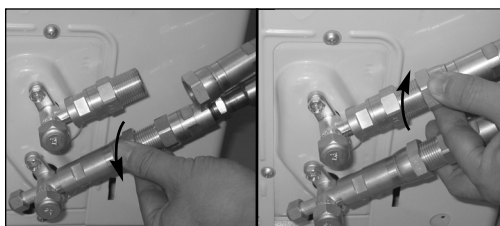

IMPORTANT! Before you continue, it is essential that you read the following instructions carefully.

4. Now tighten the bottom screw connector first and then the top screw connector using the open-ended spanner.

Hold the points marked "A" using a 22 mm open-ended spanner and turn the nuts only at the positions marked "B" using a 24 mm open-ended spanner.

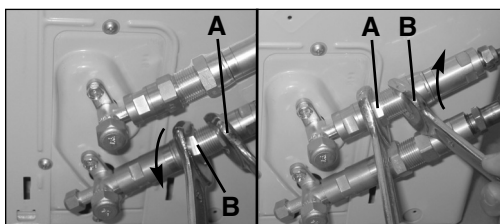

Notes:

- a) Never place the open-ended spanner in the positions marked "X".

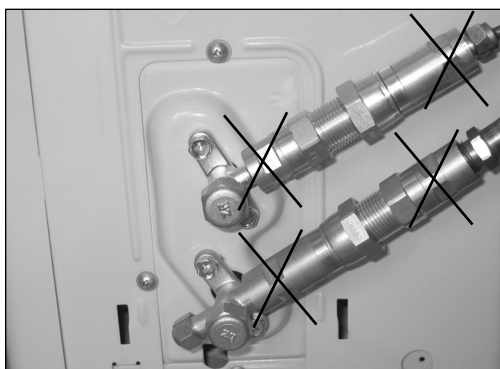

- b) Ensure that the screw connectors do not skew as you tighten them and work quickly.

Important! Since the coupling works with tapping rings, it may leak if you undo and reconnect the lines. This will also void the warranty.

After completing steps 1 – 4, check that all the connections are sealed correctly using leak detection spray or soap suds. If any bubbles form, the system has a leak and the screw connectors must be retightened using an open-ended spanner.

5. Now remove the cover on the top valve using a 19 mm open-ended spanner. Open the valve by turning it counter-clockwise as far as it will go using a 5 mm Allen key. The valve is now open. If the valve is not opened fully, the system may malfunction and suffer damage. Screw the cover back on to the top valve and tighten it well to ensure that it is properly sealed.

Important! The conical ring on the valve has an important sealing function together with the sealing seat in the caps. Ensure that you do not damage the cone and that you keep the cap free of dirt and dust.

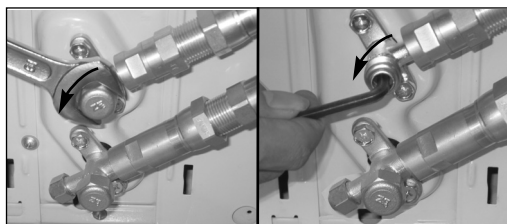

6. Now remove the cover on the bottom valve using a 19 mm open-ended spanner. Open the valve by turning it counter-clockwise as far as it will go using a 5 mm Allen key. The valve is now open. If the valve is not opened fully, the system may malfunction and suffer damage. Screw the cover back on to the bottom valve and tighten it well to ensure that it is properly sealed.

Important! The conical ring on the valve has an important sealing function together with the sealing

seat in the caps. Ensure that you do not damage the cone and that you keep the cap free of dirt and dust.

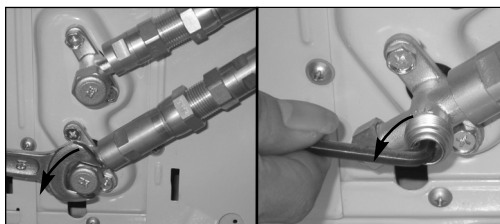

7. After completing steps 1 – 6, check that all the connections are sealed correctly using leak detection spray or soap suds. If any bubbles form, the system has a leak and the screw connectors must be retightened using an open-ended spanner.
8. Start the equipment so that the operating pressures build up inside it. Check all the connectors again for signs of leaks
 - a) during cooling mode
 - b) in heating mode.
 If any bubbles form, the system has a leak and the screw connectors must be retightened using an open-ended spanner.

6. Electrical connection

6.1 Important notes

- Follow all instructions and notes on electrical connection.

6.2 Connecting the electrical elements between the indoor and the outdoor device

- Remove the cable clamps.
- Connect the exposed end of the connection cable which leads from the indoor device to the

outdoor device to the plug-coupling system on the outdoor device.

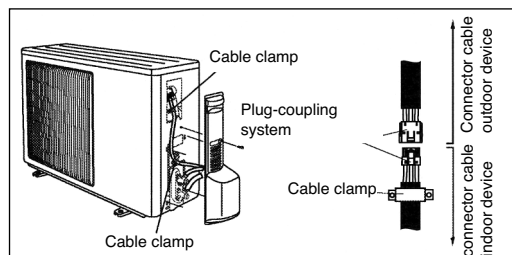

- Fasten the connector cable to the outdoor device using the cable clamps.
- Screw the connection guard back on the outdoor device.

Fasten the complete package of lines, with the protective tape wrapped around them, to the outside wall using the supplied plastic clamps.

7. Remote control holder

Before you mount the holder, check that the remote control can be received by the indoor device from the planned location for the holder. Do not select a position in direct sunlight or in the vicinity of any sources of heat.

Check that the + and – terminals on the batteries are positioned correctly in the remote control.

Fasten the remote control holder to the wall with dowels and screws.

Important

1. Have all service work performed by a specialist firm only. Request a copy of our list of service partners for any such work.
2. If ever the voltage carrying cable between the indoor device and the outdoor device should be 1. damaged, contact a specialist firm.
3. If the power cable should ever be damaged, have it replaced by an electrician.
4. Important note:
 - a) The maximum length of the coolant tube is 4 meters.
 - b) If the outdoor device is higher than the indoor device, a curve will be required in the coolant tube which is positioned below the height of the indoor device.

Notes

1. Any unauthorized modifications to the device shall not be covered by the warranty.
2. Liability for any injury or damage to property resulting from defects caused by sales, storage, transportation or unloading personnel shall rest with the person(s) causing such injury or damage to property.
3. We shall not accept liability for any damages caused by product defects resulting from improper installation by the user (including installation by any parties other than parties authorized by us, and any modifications following initial installation).
4. We shall not accept liability for any damages caused by product defects resulting from any maintenance work performed by the user (including maintenance work undertaken for the user by unauthorized third-parties).
5. We shall not accept liability for any damages caused by product defects resulting from undervoltage below 217 V ~ or overvoltage above 243 V ~, or resulting from force majeure.
6. We shall not accept liability for any damages caused by product defects resulting from improper operation by the user.
7. A damaged power cable must never be replaced by any other type of cable than the special power cable specified.
8. Pull out the power plug whenever the air conditioner is not in use.

ISC GmbH
Eschenstraße 6
D-94405 Landau/Isar

Konformitätserklärung



- D** erklärt folgende Konformität gemäß EU-Richtlinie und Normen für Artikel
- GB** declares conformity with the EU Directive and standards marked below for the article
- F** déclare la conformité suivante selon la directive CE et les normes concernant l'article
- NL** verklaart de volgende conformiteit in overeenstemming met de EU-richtlijn en normen voor het artikel
- E** declara la siguiente conformidad a tenor de la directiva y normas de la UE para el artículo
- P** declara a seguinte conformidade de acordo com a directiva CE e normas para o artigo
- S** förklarar följande överensstämmelse enl. EU-direktiv och standarder för artikeln
- IL** ilmoittaa seuraavaa Euroopan unionin direktiivien ja normien mukaista yhdenmukaisuutta tuotteelle
- N** erklærer herved følgende samsvar med EU-direktiv og standarder for artikkel
- BG** заявяет о соответствии товара следующим директивам и нормам EC
- HR** izjavljuje sljedeću uskladenost s odredbama i normama EU za artikl.
- RO** declară următoarea conformitate cu linia directoare CE și normele valabile pentru articolul.
- TR** ürün ile ilgili olarak AB Yönetmelikleri ve Normları gereğince aşağıdaki uygunluk açıklama masını sunar.
- GR** δηλώνει την ακόλουθη συμφωνία σύμφωνα με την Οδηγία ΕΕ και τα πρότυπα για το προϊόν

- I** dichiara la seguente conformità secondo la direttiva UE e le norme per l'articolo
- GB** attesterer følgende overensstemmelse i henhold til EU-direktiv og standarder for produkt
- CZ** prohlašuje následující shodu podle směrnic EU a norem pro výrobek.
- H** a következő konformitást jelenti ki a termékek-re vonatkozó EU-irányvonalak és normák szerint
- SK** pojednává sledečo skladnost po smernici EU in normah za artikel.
- PL** deklaruje zgodność wymienionego poniżej artykułu z następującymi normami na podstawie dyrektywy WE.
- SR** vydáva nasledujúce prehlásenie o zhode podľa smernice EU a noriem pre výrobok.
- RO** декларира следното съответствие съгласно директивите и нормите на ЕС за продукта.
- UKR** заявляє про відповідність згідно з Директивою ЄС та стандартами, чинними для даного товару
- EE** deklareerib vastavuse järgnevalele EL direktiivi dele ja normidele
- LT** deklaruoja atitiktą pagal ES direktyvas ir normas straipsniui
- ES** izjavljuje sledeći konformitet u skladu s odredbom EZ i normama za artikl
- LV** Atbilstības sertifikāts apliecina zemāk minēto preču atbilstību ES direktīvām un standartiem
- IS** Samræmisvirkýsing staðfestir eftirfarandi samræmi samkvæmt reglum Evrópubandalagsins og stöðlum fyrir vörur

Klima-Splitanlage SPLIT 900 EQ C+H

- | | |
|----------------------------------------------------------|-------------------------------------------|
| <input type="checkbox"/> 98/37/EG | <input type="checkbox"/> 87/404/EWG |
| <input checked="" type="checkbox"/> 73/23/EWG_93/68/EEC | <input type="checkbox"/> R&TTED 1999/5/EG |
| <input type="checkbox"/> 97/23/EG | <input type="checkbox"/> 2000/14/EG: |
| <input checked="" type="checkbox"/> 89/336/EWG_93/68/EEC | <input type="checkbox"/> 95/54/EG: |
| <input type="checkbox"/> 90/396/EWG | <input type="checkbox"/> 97/68/EG: |
| <input type="checkbox"/> 89/686/EWG | |

EN 55014-1+A1+A2; EN 55014-2+A1; EN 61000-3-2; EN 61000-3-3+A1;
EN 60335-1+A1+A11; EN 60335-2-40+A11+A12; EN 50366

Landau/Isar, den 24.10.2006

Weichselgartner
General-Manager

Sievers
Product-Management

Art.-Nr.: 23.657.12 I.-Nr.: 01016
Subject to change without notice

Archivierung: 2365710-06-4155050

GUARANTEE CERTIFICATE

Dear Customer,

All of our products undergo strict quality checks to ensure that they reach you in perfect condition. In the unlikely event that your device develops a fault, please contact our service department at the address shown on this guarantee card. Of course, if you would prefer to call us then we are also happy to offer our assistance under the service number printed below. Please note the following terms under which guarantee claims can be made:

1. These guarantee terms cover additional guarantee rights and do not affect your statutory warranty rights. We do not charge you for this guarantee.
2. Our guarantee only covers problems caused by material or manufacturing defects, and it is restricted to the rectification of these defects or replacement of the device. Please note that our devices have not been designed for use in commercial, trade or industrial applications. Consequently, the guarantee is invalidated if the equipment is used in commercial, trade or industrial applications or for other equivalent activities. The following are also excluded from our guarantee: compensation for transport damage, damage caused by failure to comply with the installation/assembly instructions or damage caused by unprofessional installation, failure to comply with the operating instructions (e.g. connection to the wrong mains voltage or current type), misuse or inappropriate use (such as overloading of the device or use of non-approved tools or accessories), failure to comply with the maintenance and safety regulations, ingress of foreign bodies into the device (e.g. sand, stones or dust), effects of force or external influences (e.g. damage caused by the device being dropped) and normal wear resulting from proper operation of the device.

The guarantee is rendered null and void if any attempt is made to tamper with the device.

3. The guarantee is valid for a period of 2 years starting from the purchase date of the device. Guarantee claims should be submitted before the end of the guarantee period within two weeks of the defect being noticed. No guarantee claims will be accepted after the end of the guarantee period. The original guarantee period remains applicable to the device even if repairs are carried out or parts are replaced. In such cases, the work performed or parts fitted will not result in an extension of the guarantee period, and no new guarantee will become active for the work performed or parts fitted. This also applies when an on-site service is used.
4. In order to assert your guarantee claim, please send your defective device postage-free to the address shown below. Please enclose either the original or a copy of your sales receipt or another dated proof of purchase. Please keep your sales receipt in a safe place, as it is your proof of purchase. It would help us if you could describe the nature of the problem in as much detail as possible. If the defect is covered by our guarantee then your device will either be repaired immediately and returned to you, or we will send you a new device.

Of course, we are also happy offer a chargeable repair service for any defects which are not covered by the scope of this guarantee or for units which are no longer covered. To take advantage of this service, please send the device to our service address.

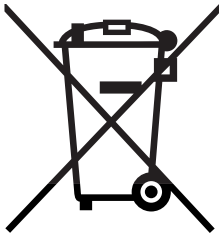

Ⓒ For EU countries only

Never place any electric tools in your household refuse.

To comply with European Directive 2002/96/EC concerning old electric and electronic equipment and its implementation in national laws, old electric tools have to be separated from other waste and disposed of in an environment-friendly fashion, e.g. by taking to a recycling depot.

Recycling alternative to the demand to return electrical devices:

As an alternative to returning the electrical device, the owner is obliged to cooperate in ensuring that the device is properly recycled if ownership is relinquished. This can also be done by handing over the used device to a returns center, which will dispose of it in accordance with national commercial and industrial waste management legislation. This does not apply to the accessories and auxiliary equipment without any electrical components which are included with the used device.

Ⓒ

The reprinting or reproduction by any other means, in whole or in part, of documentation and papers accompanying products is permitted only with the express consent of ISC GmbH.

Ⓒ Technical changes subject to change

