



# **ROTARY HAMMER DRILL KIT**

- **5 JOULES**
- **1250W POWER**



## **INSTRUCTION MANUAL**

**⚠ WARNING: Read all safety warnings and instructions before use. Failure to follow the warnings and instructions may result in electric shock, fire and/or serious injury. Save these warnings and instructions for future reference.**

## SPECIFICATIONS - MODEL NO. FBT-0500U

<b>Voltage:</b>	230V ~ 50Hz
<b>Power:</b>	1250W
<b>Impact Power:</b>	5 Joules
<b>Impact Rate:</b>	0-4,100/min
<b>No Load Speed:</b>	0-850/min
<b>Accessory Fitment:</b>	SDS-Plus
<b>Drilling Capacity:</b>	32mm
<b>Weight:</b>	7.9kg

## KNOW YOUR PRODUCT

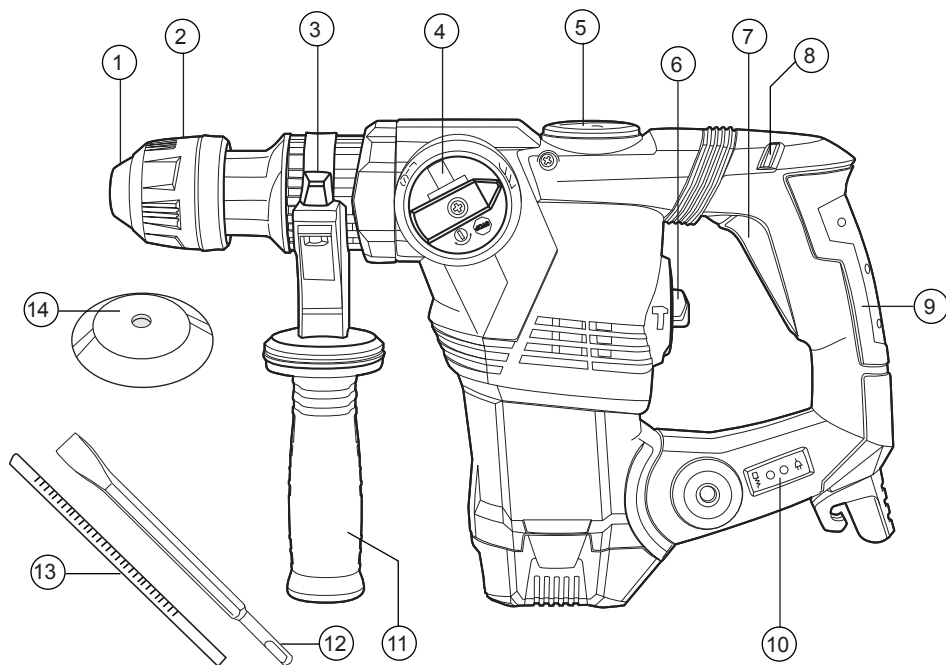

- |                              |                                  |
|------------------------------|----------------------------------|
| 1. SDS-plus accessory holder | 8. Pressure indicator light      |
| 2. Accessory locking sleeve  | 9. Soft grip rear handle         |
| 3. Depth rod locking dial    | 10. Service indicator LED        |
| 4. Side mode selector        | 11. Side handle                  |
| 5. Grease cap                | 12. 250mm x 24mm flat chisel bit |
| 6. Rear mode selector        | 13. Depth rod                    |
| 7. On/off trigger            | 14. Dust cover                   |

## TABLE OF CONTENTS

SPECIFICATIONS.....	Page 02
KNOW YOUR PRODUCT.....	Page 02
INTRODUCTION.....	Page 04
SAFETY INSTRUCTIONS.....	Page 04
SET UP.....	Page 08
CHOOSING AN OPERATION MODE.....	Page 09
OPERATION.....	Page 10
MAINTENANCE.....	Page 11
TROUBLE SHOOTING .....	Page 12
DESCRIPTION OF SYMBOLS.....	Page 13
CONTENTS.....	Page 14
WARRANTY.....	Page 16

## INTRODUCTION

Congratulations on purchasing a Full Boar rotary hammer kit. It has been designed to rapidly drill, chip, chisel and break masonry products such as concrete.

Read and understand the instruction manual before operating the demolition hammer. Failure to do so could result in personal injury or equipment damage.

## ELECTRICAL SAFETY

 **WARNING!** When using mains-powered tools, basic safety precautions, including the following, should always be followed to reduce risk of fire, electric shock, personal injury and material damage.

Read the whole manual carefully, and make sure you know how to switch the tool off in an emergency, before operating the tool. Save these instructions and other documents supplied with this tool for future reference. The manufacturer cannot accept any liability for damage or accidents which arise due to a failure to follow these instructions and the safety information.

Before you connect the equipment to the mains supply make sure that the data on the rating plate is identical to the mains data.



This tool is double insulated therefore no earth wire is required.

The power supply for this product should be protected by a residual current device (rated at 30mA or less). A residual current device reduces the risk of electric shock.

If the supply cord of this power tool is damaged, it must be replaced by a specially prepared cord available through the service organisation.

Note: Double insulation does not take the place of normal safety precautions when operating this tool. The insulation system is for added protection against injury resulting from a possible electrical insulation failure within the tool.

### Using an extension lead

Always use an approved extension lead suitable for the power input of this tool. Before use, inspect the extension lead for signs of damage, wear and ageing. Replace the extension lead if damaged or defective.

When using an extension lead on a reel, always unwind the lead completely. Use of an extension lead not suitable for the power input of the tool or which is damaged or defective may result in a risk of fire and electric shock.

## GENERAL SAFETY INSTRUCTIONS

 **WARNING!** Read all safety warnings and all instructions. Failure to follow the warnings and instructions may result in electric shock, fire and/or serious injury.

Save all warnings and instructions for future reference. The term 'power tool' in the warnings refers to your mains-operated (corded) power tool or battery-operated (cordless) power tool.

### 1. WORK AREA SAFETY

- a. **Keep work area clean and well lit.** Cluttered or dark areas invite accidents.
- b. **Do not operate power tools in explosive atmospheres, such as in the presence of flammable liquids, gases or dust.** Power tools create sparks, which may ignite the dust or fumes.
- c. **Keep children, pets and bystanders away while operating a power tool.** Distractions can cause you to lose control.

### 2. ELECTRICAL SAFETY

- a. **Power tool plugs must match the outlet. Never modify the plug in any way. Do not use any adapter plugs with earthed (grounded) power tools.** Unmodified plugs and matching outlets will reduce risk of electric shock.
- b. **Avoid body contact with earthed or grounded surfaces, such as pipes, radiators, ranges and refrigerators.** There is an increased risk of electric shock if your body is earthed or grounded.
- c. **Do not expose power tools to rain or wet conditions.** Water entering a power tool will increase the risk of electric shock.
- d. **Do not abuse the cord. Never use the cord for carrying, pulling or unplugging the power tool. Keep cord away from heat, oil, sharp edges or moving parts.** Damaged or entangled cords increase the risk of electric shock.
- e. **When operating a power tool outdoors, use an extension cord suitable for outdoor use.** Use of a cord suitable for outdoor use reduces the risk of electric shock.
- f. **If operating a power tool in a damp location is unavoidable, use a residual current device (RCD) protected supply.** Use of an RCD reduces the risk of electric shock.

### 3. PERSONAL SAFETY

- a. **Stay alert, watch what you are doing and use common sense when operating a power tool. Do not use a power tool while you are tired or under the influence of drugs, alcohol or medication.** A moment of inattention while operating power tools may result in serious personal injury.
- b. **Use personal protective equipment. Always wear eye protection.** Protective equipment such as dust mask, non-skid safety shoes, hard hat, or hearing protection used for appropriate conditions will reduce personal injuries. Wear ear protectors when impact drilling. Exposure to noise can cause hearing loss.
- c. **Prevent unintentional starting. Ensure the switch is in the off-position before connecting to power source and/or battery pack, picking up or carrying the tool.** Carrying power tools with your finger on the switch, or energising power tools that have the switch on, invites accidents.
- d. **Remove any adjusting key or wrench before turning the power tool on.** A wrench or a key left attached to a rotating part of the power tool may result in personal injury.
- e. **Do not overreach. Keep proper footing and balance at all times.** This enables better control of the power tool in unexpected situations.
- f. **Dress properly. Do not wear loose clothing or jewellery. Keep your hair, clothing and gloves away from moving parts.** Loose clothes, jewellery or long hair can be caught in moving parts.
- g. **If devices are provided for the connection of dust extraction and collection facilities, ensure these are connected and properly used.** Use of dust collection can reduce dust-related hazards.

### 4. POWER TOOL USE AND CARE

- a. **Do not force the power tool. Use the correct power tool for your application.** The correct power tool will do the job better and safer at the rate for which it was designed.
- b. **Do not use the power tool if the switch does not turn it on and off.** Any power tool that

## GENERAL POWER TOOL SAFETY WARNINGS

cannot be controlled with the switch is dangerous and must be repaired.

- c. **Disconnect the plug from the power source and/or the battery pack from the power tool before making any adjustments, changing accessories, or storing power tools.** Such preventive safety measures reduce the risk of starting the power tool accidentally.
- d. **Store idle power tools out of the reach of children and do not allow persons unfamiliar with the power tool or these instructions to operate the power tool.** Power tools are dangerous in the hands of untrained users.
- e. **Maintain power tools. Check for misalignment or binding of moving parts, breakage of parts and any other condition that may affect the power tool's operation. If damaged, have the power tool repaired before use.** Many accidents are caused by poorly maintained power tools.
- f. **Keep cutting tools sharp and clean.** Properly maintained cutting tools with sharp cutting edges are less likely to bind and are easier to control.
- g. **Use the power tool, accessories and tool bits, etc. in accordance with these instructions, taking into account the working conditions and the work to be performed.** Use of the power tool for operations different from those intended could result in a hazardous situation.

### 5. SERVICE

- a. **Have your power tool serviced by a qualified repair person using only identical replacement parts.** This will ensure that the safety of the power tool is maintained.

## ROTARY HAMMER DRILL SAFETY WARNINGS

- Wear ear protectors. Exposure to noise can cause hearing loss.
- **Use auxiliary handle(s), if supplied with the tool.** Loss of control can cause personal injury.
- **Hold power tool by insulated gripping surfaces, when performing an operation where the cutting accessory may contact hidden wiring or its own cord.** Cutting accessory contacting a 'live' wire may make exposed metal parts of the power tool 'live' and could give the operator an electric shock.



**WARNING!** This appliance is not intended for use by persons (including children) with reduced physical, sensory or mental capabilities, or lack of experience and knowledge, unless they have been given supervision or instruction concerning use of the appliance by a person responsible for their safety.

**Recommendations for the use of a residual current device** with a rated residual current of 30mA or less.

### Using an extension lead

- Always use an approved extension lead suitable for the power input of this tool. Before use, inspect the extension lead for signs of damage, wear and ageing. Replace the extension lead if damaged or defective.
- When using an extension lead on a reel, always unwind the lead completely. Use of an extension lead not suitable for the power input of the tool, or which is damaged or defective, may result in a risk of fire and electric shock.
- It is recommended that the extension lead is a maximum of 25m in length. **Do Not** use multiple extension leads.
- Before drilling into walls, ceilings, etc., ensure there are no concealed power cables or pipes in the cavity.
- Always use the side handle, this gives you greater control if the accessory should become jammed.
- Keep the cord clear of the accessory being used; do not wrap the cord around your arm or wrist.
- Hold the tool by the insulated gripping surfaces when performing an operation where the accessory may contact hidden wiring or its own cord.

## ROTARY HAMMER DRILL SAFETY WARNINGS

- Use thick, cushioned gloves and limit the exposure time by taking frequent breaks.
- Vibration caused by the hammer action may be harmful to your hands and arms.
- When removing an accessory from the tool, avoid contact with skin and use proper protective gloves when grasping the bit or accessory. Accessories may be hot after prolonged use.



**WARNING!** Some dust created by power sanding, sawing, grinding, drilling and other construction activities, contain chemicals known to cause cancer, birth defects or other reproductive harm.

Some examples of these chemicals are:

- Lead from lead-based paints;
- Crystalline silica from bricks, cement and other masonry products, and;
- Arsenic and chromium from chemically-treated timber.

The risk from such exposures vary depending on how often you do this type of work. To reduce your exposure to these chemicals, work in a well-ventilated area, and work with approved safety equipment, such as those dust masks that are specifically designed to filter out microscopic particles.

Always wear eye protection and a dust mask for dusty applications, and when drilling/chiselling overhead. Sanding particles can be absorbed by your eyes and inhaled easily, and may cause health complications.

### Special requirements:

- Wear ear protectors. Exposure to noise can cause hearing loss.
- Use auxiliary handles supplied with the tool. Loss of control can cause personal injury.

## SET-UP & PREPARATION

**WARNING!** Ensure the tool is turned off and disconnected from the power supply before performing any of the following operations.

### Using the depth rod

The Full Boar FBT-0500U comes with a depth rod that allows you to drill to a pre-determined depth.

1. Loosen the depth rod securing nut then insert the depth rod (Fig. 1).
2. Adjust the depth rod so the drill bit extends beyond the end of the depth rod to the required drilling depth (Fig. 2).
3. Tighten the depth rod securing nut to lock the depth rod into place.
4. Drill the hole until the end of the depth rod touches the workpiece.

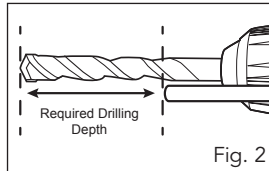
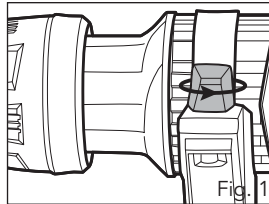

### Fitting SDS-plus accessories

1. Prior to insertion into the chuck, remove any dust and debris from the SDS-plus accessory, then apply some lubricant to the end of the accessory.
2. Pull and hold the locking sleeve back. Insert the SDS-plus accessory (Fig. 3).
3. Rotate the accessory and continue to insert as far as possible into the chuck. Release the locking sleeve.
4. Check the SDS-plus accessory is properly secured in the chuck by pulling on the accessory. Note: It should have approx. 10-20mm of movement. This is normal (Fig. 1).
5. To remove the SDS-plus accessory, pull back the locking sleeve and then pull the accessory out of the chuck.

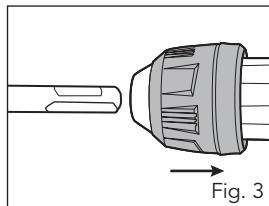

### Fitting the dust cover

The dust cover catches dust and debris while using the drill in an upright or overhead position, helping to avoid dust entering the air vents.

1. Slide the dust cover over the accessory to be fitted (Fig. 4). Add lubrication to the end of accessory before inserting into the SDS-plus chuck.
2. Pull back the accessory locking sleeve and insert the accessory. Release the locking sleeve.
3. Press the dust cover into the end of the locking sleeve.

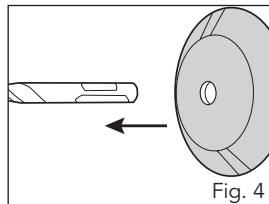

## CHOOSING AN OPERATION MODE

The Full Boar FBT-0500U has 4 different operating modes: drilling, hammer drilling, chiselling with fixation and chiselling without fixation. Follow the instructions below to select your desired mode of operation.

	Side Mode Selector	Rear Mode Selector
<b>Drilling</b> Rotate the side mode selector to the drill icon, and rotate the rear mode selector to the no hammer icon. This setting is recommended for use when you desire the accessory to rotate without hammer action. Ideal for drilling into timber or steel when correct accessories for such materials are used.		
<b>Hammer drilling</b> Rotate the side mode selector to the drill icon, and rotate the rear mode selector to the hammer icon. This setting is recommended for use when drilling holes in concrete and other masonry products. The hammer action will be in operation while the drill bit rotates simultaneously.		
<b>Chiselling (free rotation)</b> Rotate the side mode selector to the free rotation chiselling mode and rotate the rear mode selector to the hammer icon. This setting is helpful when you want to have the chisel in a particular position. The bit will stop rotating once contact is made with the material, or you can rotate the bit by hand. Once you have found the ideal position, you can change to chiselling (locked) for continual use.		
<b>Chiselling (locked)</b> Rotate the side mode selector to the chisel icon, and rotate the rear mode selector to the hammer icon. This setting is recommended for use when you desire a hammer action without the accessory rotating, which is ideal for 'chiseling or chipping' away at masonry products, pick or chisel accessory bits should be used.		

## OPERATION

1. Ensure your workpiece is securely clamped where possible.
2. Connect the tool to the mains power supply. The ready for use indicator LED will illuminate when the tool is connected to power and ready for use (Fig. 5).
3. Select the desired mode of operation (refer to Choosing an Operation mode section of manual).
4. Hold the rotary hammer drill to the work surface. Apply enough pressure on the rear handle so that the press control indicator on the side of the housing goes green (Fig. 6). The rotary hammer drill will work most efficiently in this position. If you apply excessive pressure, the indicator will go red. This guide prevents overloading of the tool.
5. Squeeze the on/off trigger to start drilling (Fig. 7). Release the trigger to stop drilling.

**NOTE:** Prior to changing modes, the on/off switch should be released and the drill should have come to a complete stop.

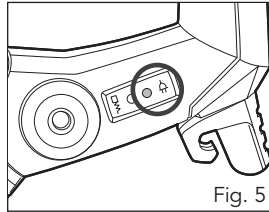

Fig. 5

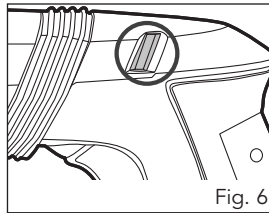

Fig. 6

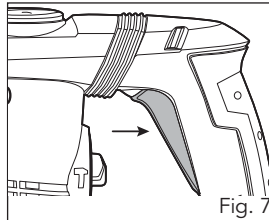

Fig. 7

## MAINTENANCE

- Keep the ventilation vents of the rotary hammer drill clean at all times.
- After each use, blow air through the rotary hammer drill housing to ensure it is free from all dust particles which may build up. Build up of dust particles may cause the rotary hammer drill to overheat and fail.
- If the enclosure of the rotary hammer drill requires cleaning, do not use solvents but a moist, soft cloth only. Never let any liquid get inside the rotary hammer drill; never immerse any part of the rotary hammer drill into a liquid.

### Gear box grease replenishment

The grease in the gearbox will require replenishment after approximately 50 hours accumulative use. After this time, add approximately 50 grams (approx 2 – 3 teaspoons) of normal ball bearing grease, into the gearbox. First remove the grease cap from the rotary hammer drill by using a pin spanner or flat head screwdriver. Once removed, add the grease through this hole. Ensure the grease cap is secured back into position prior to operation.

### Carbon brushes

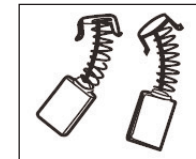





The service indicator LED (10) will illuminate when the carbon brushes need to be replaced. When the carbon brushes wear out, the rotary hammer drill will spark and/or stop. Discontinue use as soon as this happens. They should be replaced prior to recommencing use of the rotary hammer drill. Carbon brushes are a wearing component of the rotary hammer drill, therefore, not covered under warranty. Continuing to use the rotary hammer drill when carbon brushes need to be replaced may cause permanent damage to the rotary hammer drill. Carbon brushes will wear out after many uses but when the carbon brushes need to be replaced, take the rotary hammer drill to an electrician or a power tool repairer for a quick and low cost replacement. Always replace both carbon brushes at the same time.

*Note: Ozito Industries will not be responsible for any damage or injuries caused by the repair of the rotary hammer drill by an unauthorised person or by mishandling of the rotary hammer drill.*

## TROUBLESHOOTING

Problem	Cause	Remedy
<b>Rotary hammer drill is not working</b>	No power supplied.	Make sure all plugs are connected and power outlet is in working order.
	Mode Selectors in wrong position. Chisel Function will not engage if mode selectors are as shown below.	Please refer to 'Operating The Hammer Drill' section in the manual.
<b>Hammer function not engaging</b>	Excess grease has been packed.	Insert SDS-plus accessory and then set both the modes to hammer function. Turn the drill on, firmly tap the accessory bit up and down onto a scrap piece of material to activate.
	Motor brushes binding in brush holders.	Clean brush holders. Remove carbon dust by using compressed air to blow out brush dust.
<b>Excessive sparking visible through air vents</b>	Carbon brushes have worn out.	Replace carbon brushes as per maintenance section.

## DESCRIPTION OF SYMBOLS

V	Volts	Hz	Hertz
~	Alternating current	W	Watts
/min	Revolutions or reciprocation per minute	n <sub>0</sub>	No load speed
mm	Millimetres	∅	Diameter
	Double insulated		Read instruction manual
	Warning		Wear eye protection
	Wear ear protection		

## CONTENTS

1 x Rotary hammer drill	1 x Dust cover
1 x Depth rod	1 x Carry case
1 x 250mm flat chisel bit	

**Note:** The manufacturer's liability shall be deemed void if the machine is modified in any way, and the manufacturer shall, therefore, accept no liability for any damages arising as a result of modifications.



# WARRANTY

All of our products undergo strict quality checks to ensure that they reach you in perfect condition. In the unlikely event that your device develops a fault, please contact our service department at the address shown on this guarantee card. You can also contact us by telephone using the customer service number shown. Please note the following terms under which guarantee claims can be made:

1. These warranty terms regulate additional warranty services, which the manufacturer (mentioned below) promises to buyers of its new products. In addition to their statutory guarantee, claims are not affected by this guarantee. Our guarantee is free of charge to you.
2. The warranty services only covers defects due to material or manufacturing faults on this product which you have bought from the manufacturer (mentioned below) and are limited to either the rectification of said defects on the product or the replacement of the product, whichever we prefer.
3. The following are not covered by our guarantee:
  - Damage to the device caused by a failure to follow the assembly instructions or due to incorrect installation; a failure to follow the operating instructions (for example, connecting it to an incorrect mains voltage or current type) or a failure to follow the maintenance and safety instructions; or by exposing the device to abnormal environmental conditions, or by lack of care and maintenance.
  - Damage to the device caused by abuse or incorrect use (for example, overloading the device, or the use of unapproved tools or accessories), ingress of foreign bodies into the device (such as sand, stones or dust, transport damage), the use of force or damage caused by external forces (for example, by dropping it).
  - Damage to the device or parts of the device caused by normal or natural wear or tear, or by normal use of the device.
4. Your product is guaranteed for a period of 12 months from the original date of purchase. Warranty excludes consumable parts. Guarantee claims should be submitted before the end of the guarantee period and within two weeks of the defect being noticed. No guarantee claims will be accepted after the end of the guarantee period. The original guarantee period remains applicable to the device even if repairs are carried out or parts are replaced. In such cases, the work performed or parts fitted will not result in an extension of the guarantee period, and no new guarantee will become active for the work performed or parts fitted. This also applies if an on-site service is used.

Your statutory rights remain unaffected, in particular, any rights you have under the Consumer Rights Act 2015.

**IN ORDER TO MAKE A CLAIM UNDER THIS WARRANTY, YOU MUST RETURN THE PRODUCT TO THE PLACE OF PURCHASE WITH YOUR RECEIPT.**

Please refer to the restrictions of this warranty concerning wearing parts, consumables and missing parts, as set out in the service information in these operating instructions.

**CUSTOMER SERVICE HELPLINE**

GB: 0151 294 4488

IRL: 1850 882711

**OZITO UK**

Unit 9 Stadium Court, Wirral International Business Park, Plantation Road,  
Bromborough, Wirral, CH62 3QG