

MAINTENANCE

- Keep the vents of the sander clean at all times. If possible, prevent foreign matter from entering the vents.
- After each use, blow air through the sander housing to ensure it is free from all dust particles which may build up. Build up of dust particles may cause the sander to overheat and fail.
- If the enclosure of the sander requires cleaning, do not use solvents but a moist soft cloth only. Never let any liquid get inside the sander; never immerse any part of the sander into a liquid.

Carbon Brushes



When the carbon brushes wear out, the sander will spark and/or stop. Discontinue use as soon as this happens. They should be replaced prior to recommencing use of the sander. Carbon brushes are a wearing component of the sander and are therefore not covered under warranty. Continuing to use the sander when carbon brushes need to be replaced may cause permanent damage to the sander. Carbon brushes will wear out after many uses. When the carbon brushes need to be replaced, take the sander to an electrician or a power tool repairer for a quick and low cost replacement. Always replace both carbon brushes at the same time.

Note: Ozito Industries will not be responsible for any damage or injuries caused by the repair of the sander by an unauthorised person or by mishandling of the sander.

DESCRIPTION OF SYMBOLS

V	Volts	Hz	Hertz
~	Alternating current	W	Watts
/min	Revolutions or reciprocation per minute	No	No load speed
/bpm	Orbital per minute	∅	Diameter
	Double insulated		Read Instruction Manual
	Warning		

TROUBLE SHOOTING

Sparking visible through the housing air vents

A small amount of sparking may be visible through the housing vents. This is normal and does not indicate a problem.

Excessive sparking visible through the housing air vents and/or the drill failing to operate

May indicate the carbon brushes have worn out and need to be replaced. Carbon brushes should only be replaced by a qualified electrician or power tool repairer.

Sandpaper Selection

Selecting the correct grit of sandpaper is an important step in achieving optimum results. Coarse grit will remove the most material. Finer grit will produce a smoother finish. The condition of the workpiece will determine the grit of the sandpaper to be used. The higher the grit number, the finer the grade of sandpaper.

If the surface is rough, start with a coarse grit and sand until the surface is uniform. Medium grit may then be used to remove scratches left by the coarser grit. Finer grit is then used to finish the surface. Always continue sanding with each grade of sandpaper until the surface is uniform.

MATERIAL	APPROPRIATE GRIT	
	Coarse Sanding	Fine Sanding
Paintwork	180	400
Wood:	Softwood	60
	Hardwood	60
Veneer	240	320

Note: If intermediate sanding is required, choose a grit rating between coarse and fine. The above table is intended as a guide only. To ensure a satisfactory result, a small, inconspicuous area should first be tested to ensure the grit of sandpaper chosen is suitable for the desired finish.

Sanding Tips

Never force the sander. The weight of the sander supplies adequate pressure, allowing the sandpaper to do the work. Applying additional pressure will slow the motor, rapidly wear the sandpaper, and greatly reduce the sander speed. This will slow the removal rate and produce an inferior quality surface.

CAUTION: Excessive pressure will overload the motor, causing possible damage to the sander by overheating the motor; or damage to the workpiece.

Be sure to check your workpiece often. The sander is capable of removing material rapidly, especially with coarse paper.

The orbital action of your sander allows you to sand with the grain, or at any angle across it for most sanding jobs. In the final stages a better finish will be achieved by sanding with the grain.

Do not sand on one spot for too long. The sander's rapid action may remove too much material, creating an uneven surface.

SPARE PARTS

Spare parts can be ordered from the **Special Orders Desk** at your local Bunnings Warehouse or Homebase store.

For further information, or any parts visit

www.ozito-diy.co.uk or contact **Ozito Customer Service:**

Great Britain: 0151 294 4488

Ireland: 1850 882711

E-mail: enquires@ozito-diy.co.uk

ELECTRICAL SAFETY

WARNING! When using mains-powered tools, basic safety precautions, including the following, should always be followed to reduce risk of fire, electric shock, personal injury and material damage.

Read the whole manual carefully and make sure you know how to switch the tool off in an emergency, before operating the tool.

Save these instructions and other documents supplied with this tool for future reference.

Before you connect the equipment to the mains supply make sure that the data on the rating plate are identical to the mains data.



This tool is double insulated therefore no earth wire is required.

GENERAL POWER TOOL SAFETY WARNINGS

WARNING! Read all the safety information, instructions, illustrations and technical data provided on or with this power tool. Failure to adhere to the following instructions may result in electric shock, fire and/or serious injury.

Keep all the safety information and instructions in a safe place for future use.

The term "power tool" used in the safety information and instructions refers to power tools operated from the mains power supply (with a power cable) and to battery operated power tools (without a power cable).

- Workplace safety**
 - Keep your work area clean and well lit. Untidy or unlit work areas can result in accidents.
 - Do not use this power tool in an area where there is a risk of explosion and where there are inflammable liquids, gases or dust. Power tools generate sparks that can ignite dust or vapors.
 - Keep children and other people away from the power tool while you are using it. If you are distracted you may lose control of the power tool.

2. Electrical safety

- The plug on the power tool must fit into the socket. The socket must not be modified in any way. Do not use adapter plugs together with power tools with a protective earth. Unmodified plugs and matching sockets will reduce the risk of an electric shock.

3. Avoid body contact with earthed surfaces such as pipes, heating systems, stoves and refrigerators. There is an increased risk of suffering an electric shock if your body is earthed.

- Keep the power tool out of the rain and away from moisture. The ingress of water into an electric power tool increases the risk of an electric shock.

4. Do not use the power cable for a purpose for which it is not designed, for example to carry the power tool, hang it up or to pull the plug out of the socket. Keep the power cable away from heat, oil, sharp edges and moving parts. Power cables that are damaged or tangled increase the risk of an electric shock.

- If you use an electric power tool outdoors, use only extension cables that are suitable for outdoor use. The use of an extension cable which is suitable for outdoor use reduces the risk of an electric shock.

5. If you cannot avoid using the power tool in a damp location, use a residual current device (RCD) circuit breaker. The use of a residual current device (RCD) circuit breaker will reduce the risk of suffering an electric shock.

3. Safety of persons

- Be careful, watch what you are doing and be sensible and responsible when using an electric power tool. Never use the power tool if you are tired or under the influence of drugs, alcohol or medication. One moment of inattention when using the electric tool can result in serious injuries.

6. Wear personal safety equipment and always wear safety goggles. Wearing personal safety equipment such as dust masks, non-slip safety shoes, a helmet or ear plugs, depending on the type and application of the tool, reduces the risk of injury.

- Make sure that the tool cannot start up accidentally. Ensure that the power tool is switched off before you connect it to the power supply and/or connect the battery pack, pick it up or carry it. If you have your

finger on the switch while carrying the power tool or if you connect the power tool to the power supply while it is switched on, this may cause accidents.

Note: Double insulation does not take the place of normal safety precautions when operating this tool. The insulation system is for added protection against injury resulting from a possible electrical insulation failure within the tool.

Using an Extension Lead

Always use an approved extension lead suitable for the power input of this tool. Before use, inspect the extension lead for signs of damage, wear and ageing. Replace the extension lead if damaged or defective.

When using an extension lead on a reel, always unwind the lead completely. Use of an extension lead not suitable for the power input of the tool or which is damaged or defective may result in a risk of fire and electric shock.

finger on the switch while carrying the power tool or if you connect the power tool to the power supply while it is switched on, this may cause accidents.

Remove all adjusting tools or wrenches before you switch on the power tool. Any tool or wrench in a rotating part of the power tool could cause injuries.

6. Avoid abnormal working postures. Make sure you stand squarely and keep your balance at all times. This will enable you to control the power tool better in unexpected situations.

7. Wear suitable clothes. Never wear loose fitting clothes or jewelry. Keep hair and clothing away from moving parts. Loose clothing, jewelry or long hair can be caught by moving parts.

8. If dust extraction devices and dust collection devices can be fitted, they must be connected and must be used correctly. The use of a dust extractor can reduce the dangers posed by dust.

9. Do not allow yourself to be lulled into a false sense of security and do not ignore the safety regulations covering electric power tools, even if you are familiar with the power tool after having used it many times. Carelessness can lead to serious injuries in just a fraction of a second.

4. Using and handling the power tool

a) Do not overload your power tool. Use the correct electric tool for the job in hand. The correct tool will enable you to work better and more safely within the specific performance range.

b) Do not use an electric power tool if the switch is defective. An electric power tool that cannot be switched on or off is dangerous and must be repaired.

c) Pull the plug out of the socket and/or remove the removable battery pack before making any adjustments to the tool, changing plug-in tool parts or putting the power tool down. These precautions will prevent the power tool starting accidentally.

d) Keep unused electric tools out of the reach of children. Do not allow people who are not familiar with the power tool or who have not read these instructions to use the power tool. Electric tools are dangerous if they are used by inexperienced people.

e) Look after power tools and plug-in tools with care. Check that moving parts function correctly and do not jam, and whether any parts are broken or damaged such that they adversely affect the function of the power tool. Have damaged parts repaired before you use the power tool. Many accidents are caused by poorly maintained electric tools.

f) Keep cutting tools sharp and clean. Carefully maintained cutting tools with sharp cutting edges will jam less and are easier to control.

g) Use the power tool, plug-in tools, etc. as set out in these instructions. Take account of the conditions in your work area and the job in hand. Using electric tools for purposes other than the one for which they are designed can result in dangerous situations.

h) Keep the handles and grip surfaces dry, clean and free from oil and grease. If the handles and grip surfaces are slippery, it will not be possible to operate and control the power tool safely in unforeseen situations.

5. Service

a) Have your power tool repaired only by trained personnel using only genuine spare parts. This will ensure that your power tool remains safe to use.

ozito

ORBITAL SANDER

1/4 SHEET

ORIGINAL INSTRUCTIONS

SPECIFICATIONS

Voltage:	230-240V - 50Hz
Power:	135W
No Load Speed:	13,000/min
Pad Shape:	1/4 Sheet
Pad Size:	(110x100mm)
Weight:	0.9kg

ozito-diy.co.uk

3 YEAR REPLACEMENT WARRANTY

WHAT'S IN THE BOX

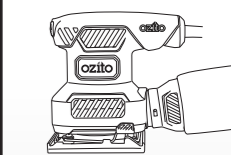

Quarter Sheet Sander



Dust Bag

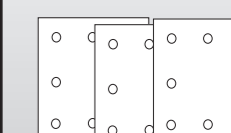

Sand Paper x 3

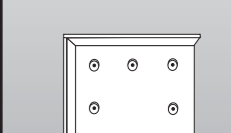

Paper Punch Plate

QSS-1000U

WARRANTY

All of our products undergo strict quality checks to ensure that they reach you in perfect condition. In the unlikely event that your device develops a fault, please contact our service department at the address shown on this guarantee card. You can also contact us by telephone using the customer service number shown. Please note the following terms under which guarantee claims can be made:

1. These warranty terms regulate additional warranty services, which the manufacturer mentioned below promises to buyers of its new products in addition to their statutory guarantee claims are not affected by this guarantee. Our guarantee is free of charge to you.

2. The warranty services only covers defects due to material or manufacturing faults on a product which you have bought from the manufacturer mentioned below are limited to either the rectification of said defects on the product or the replacement of the product, whichever we prefer.

Please note that our devices are not designed for use in commercial, trade or professional applications. A guarantee contract will not be created if the device has been used by commercial, trade or industrial business or has been exposed to similar stresses during the guarantee period.

3. The following are not covered by our guarantee:

- Damage to the device caused by a failure to follow the assembly instructions or due to incorrect installation, a failure to follow the operating instructions (for example connecting it to an incorrect mains voltage or current type) or a failure to follow the maintenance and safety instructions or by exposing the device to abnormal environmental conditions or by lack of care and maintenance.

- Damage to the device caused by abuse or incorrect use (for example overloading the device or the use of unapproved tools or accessories), ingress of foreign bodies into the device (such as sand, stones or dust, transport damage), the use of force or damage caused by external forces (for example by dropping it).

- Damage to the device or parts of the device caused by normal or natural wear or tear or by normal use of the device.

4. Your Product is guaranteed for a period of 36 months from the original date of purchase and is intended for DIY (Do It Yourself) use only. Lithium ion batteries and chargers are covered by a 12 month warranty. Warranty excludes consumable parts. Guarantee claims should be submitted before the end of the guarantee period within two weeks of the defect being noticed. No guarantee claims will be accepted after the end of the guarantee period. The original guarantee period remains applicable to the device even if repairs are carried out or parts are replaced. In such cases, the work performed or parts fitted will not result in an extension of the guarantee period, and no new guarantee will become active for the work performed or parts fitted. This also applies if an on-site service is used.

IN ORDER TO MAKE A CLAIM UNDER THIS WARRANTY YOU MUST RETURN THE PRODUCT TO THE PLACE OF PURCHASE WITH YOUR REGISTER RECEIPT.

Please refer to the restrictions of this warranty concerning wearing parts, consumables and missing parts as set out in the service information in these operating instructions.

CUSTOMER SERVICE HELPLINE

GB: 0151 294 4488

IRL: 1850 882711

Ozito-diy.co.uk

KNOW YOUR PRODUCT

QUARTER SHEET SANDER

- | | |
|---------------------------|--------------------|
| 1 On/Off Switch | 3 Sure Grip Handle |
| 2 Hook & Loop Backing Pad | 4 Spring Clamp |

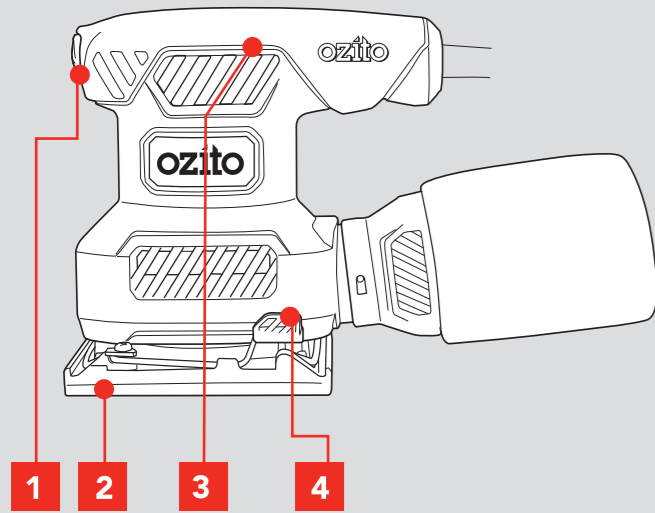

ACCESSORIES

- | | |
|------------------------------|----------------------|
| 5. Dust Bag | 7. Paper Punch Plate |
| 6. Hook & Loop Sanding Sheet | |

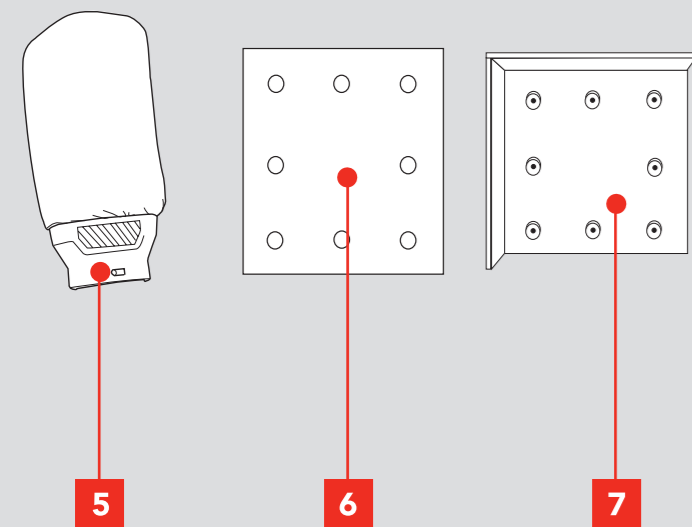

SETUP & PREPARATION

1. SANDING SHEET FITMENT

Ensure the tool is disconnected from the power supply before performing any of the following operations.

The holes on the bottom of the sanding pad allow the dust bag to draw the sanding dust away from the work area.

- When fitting the sanding sheet, align the holes on the sheet with the holes on the sanding pad.

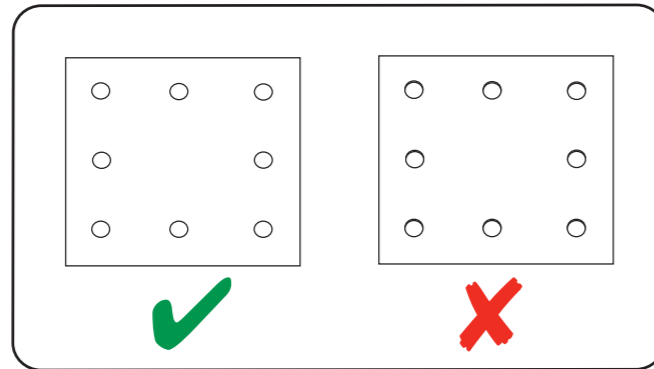

- Unlock the spring clamp on both sides of the sander.

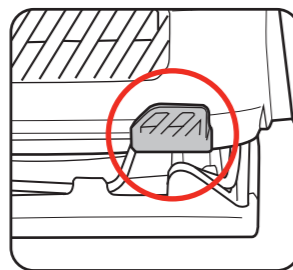

- Fold the sandpaper to match the contours of the sanding pad.

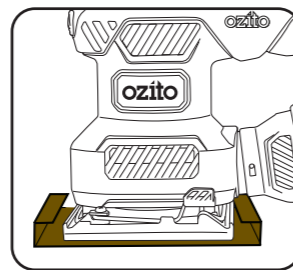

- Feed the paper under the clamp at the front of the sander. Lock the clamp.

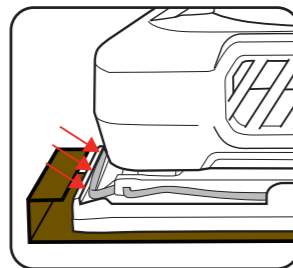

- Feed the paper under the clamp at the rear of the sander. Lock the clamp.

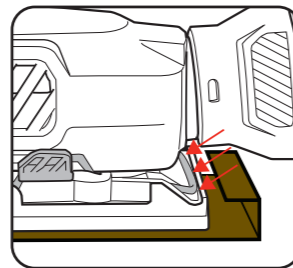

Note: Ensure the sanding sheet is firmly clamped and held flat against the base of the sanding pad.

2. PAPER PUNCH PLATE

Use the punch to create dust extraction holes on the sandpaper which align with the holes on the sander.

- Fit the 1/4 sanding sheet to the sander.

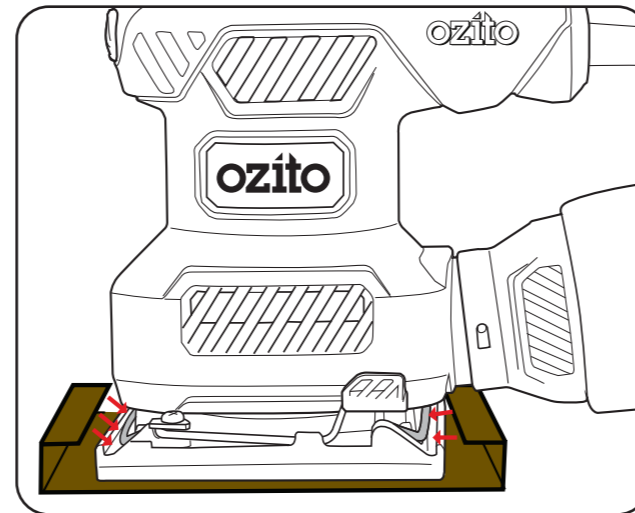

- Align the sides of the backing pad with the raised sides of the punch. Press down to punch the holes.

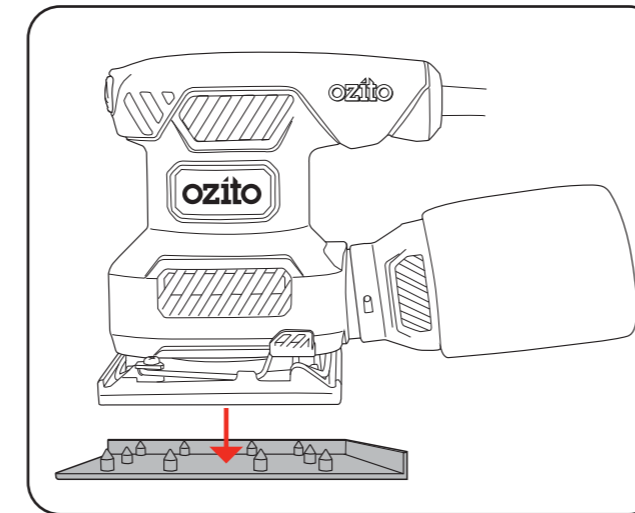

3. DUST BAG

Install

- Push the dust bag onto the dust extraction port aligning the locking tab and rotate.

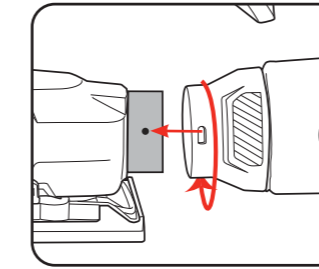

Remove

- To remove, rotate and pull the dust bag away from the extraction port.

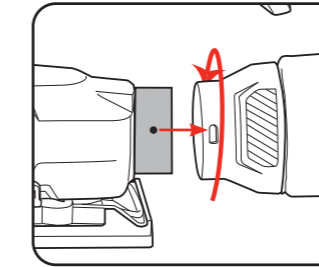

Empty

- Empty dust bag when it becomes 1/3 full for optimum dust extraction.

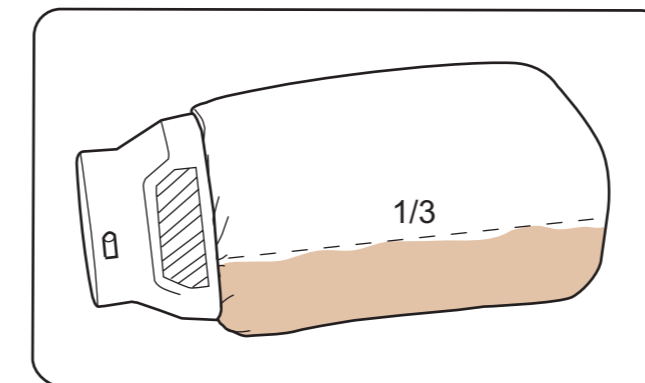

OPERATION

4. ON/OFF SWITCH

The tool is recommended for use with a residual current device with a rated residual current of 30mA or less.

- Connect the tool to the mains power supply.
- To turn the sander on, press the on/off switch.

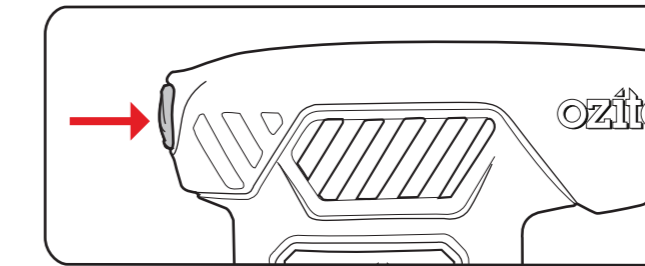

CAUTION: GUIDE THE CORD DURING SANDING TO PREVENT IT BEING CAUGHT ON THE WORKPIECE, OR OTHER OBJECTS.

- To turn the sander off, press the on/off button again.

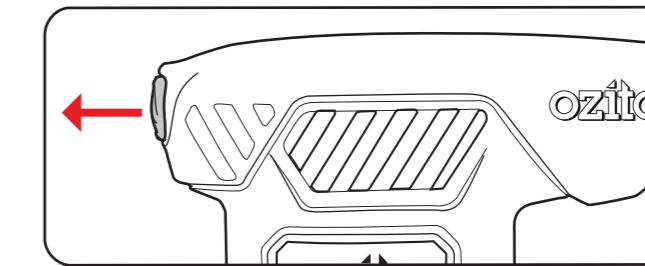

5. SANDING

- Secure the material to be sanded.
- Firmly grasp the sander. Turn it on and let the motor build up to maximum speed. Gradually lower it onto the workpiece using a forward movement.

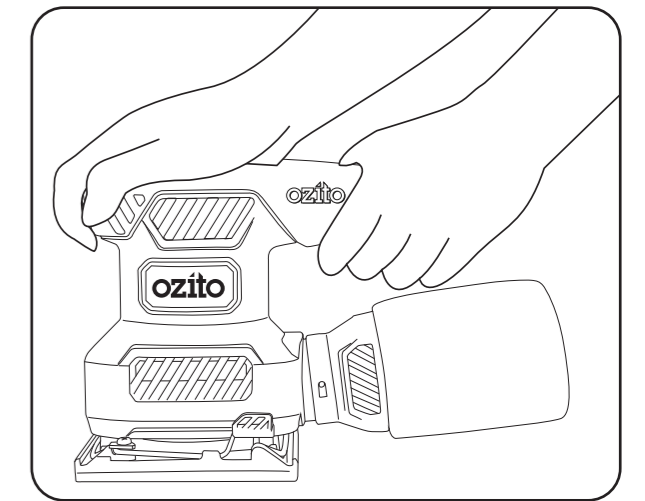

- For optimum results, use backward and forward strokes.

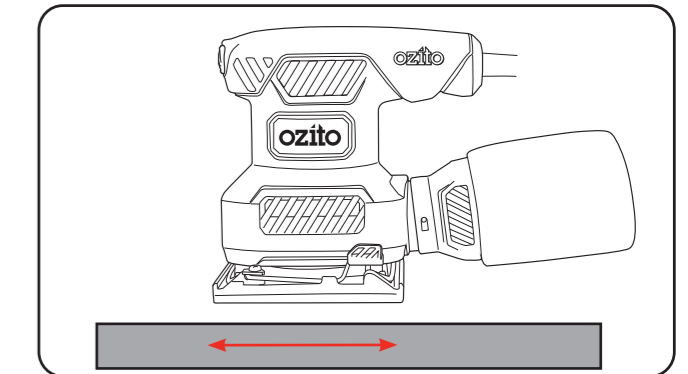

Note: Keep the entire sanding pad in contact with the workpiece at all times during sanding.

3 YEAR REPLACEMENT WARRANTY