

ozito

CORDLESS STAPLE NAIL GUN

3.6V Lithium Ion

INSTRUCTION MANUAL

SPECIFICATIONS

Input:	3.6V
Battery:	1.5Ah Li-Ion
Impact Rate:	30/min
Staple Size:	4-10mm, Type 50
Nail Size:	10mm, C1 Brad
Magazine Capacity:	65 Staples or Nails
Weight:	0.7kg

ozito.com.au

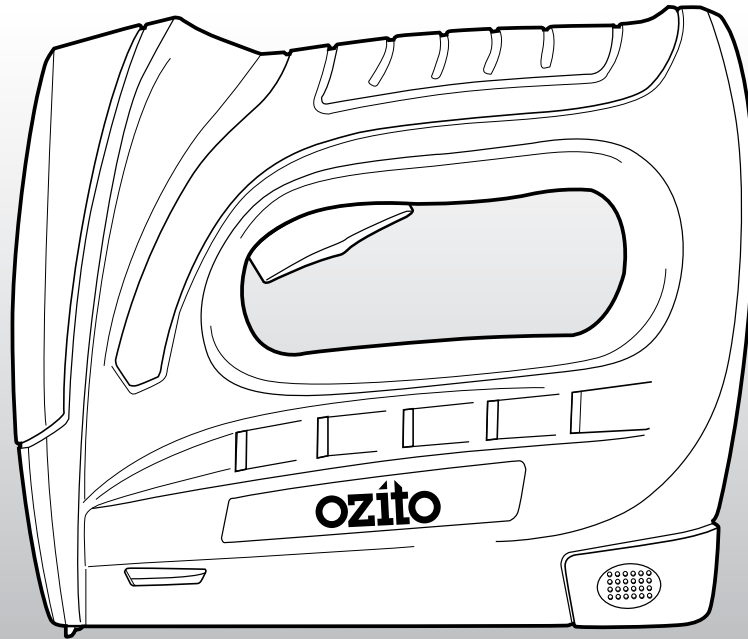

WHAT'S IN THE BOX



3.6V Staple Nail Gun



Staples x 400

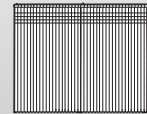

Nails x 100



Charging Adaptor

3 YEAR REPLACEMENT WARRANTY

SNL-1000

KNOW YOUR PRODUCT

CORDLESS STAPLE NAIL GUN

- | | |
|----------------------|--------------------|
| 1 Charge Indicator | 5 On/Off Trigger |
| 2 Safety Striker Pin | 6 Sure Grip Handle |
| 3 Nosepiece | 7 Magazine Latch |
| 4 Magazine Window | 8 Charging Socket |

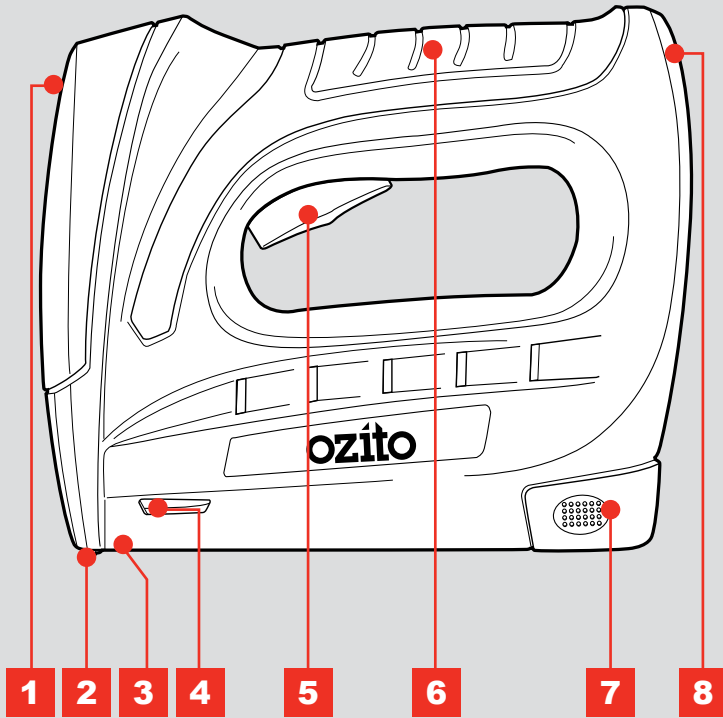

ACCESSORIES

- | | |
|-----------------|---------------------|
| 9 Staples x 400 | 11 Charging Adaptor |
| 10 Nails x 100 | 12 Charging Jack |

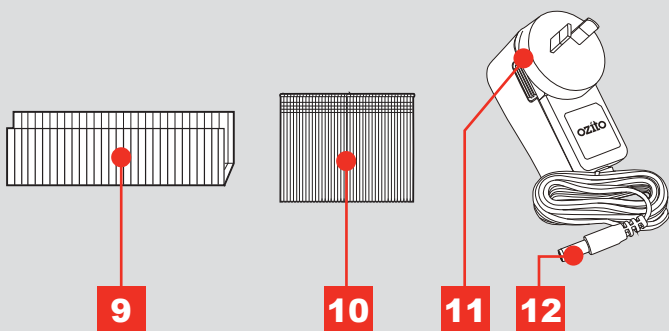

ONLINE MANUAL

Scan this QR Code with your mobile device to take you to the online manual.



SETUP & PREPARATION

1. BATTERY

CAUTION: THE POWER SUPPLY FOR THIS CHARGER SHOULD BE PROTECTED BY A RESIDUAL CURRENT DEVICE (RATED AT 30mA OR LESS). A RESIDUAL CURRENT DEVICE THAT REDUCES THE RISK OF ELECTRIC SHOCK.

Charging

The charge indicator will illuminate red if the battery is low, indicating that the battery needs charging.

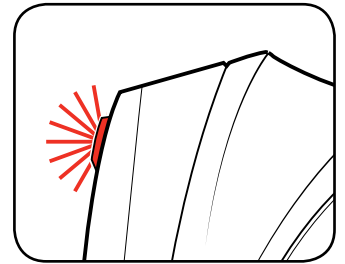

- 1 Plug the charging jack into the charging socket on the staple nail gun.

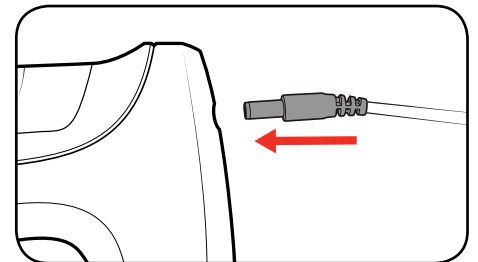

- 2 Plug the charging adaptor into a power point and switch on.

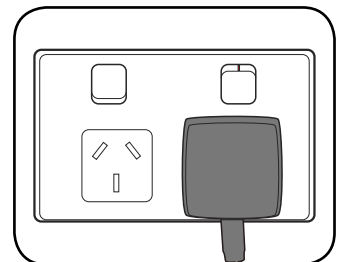

Note: The charge indicator will remain red whilst charging.

- 3 Once fully charged, the indicator light will illuminate green.

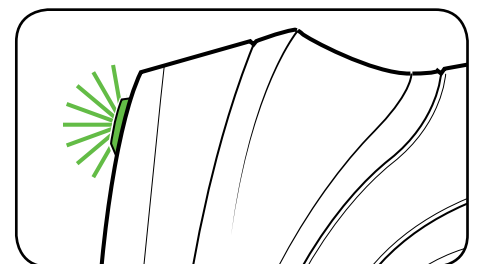

3 YEAR REPLACEMENT WARRANTY

2. LOADING STAPLES

This staple nailer only accepts T50 18 Gauge staples. Other types of staples, including paper staples, will jam the unit.

- 1 Hold the tool upside down.

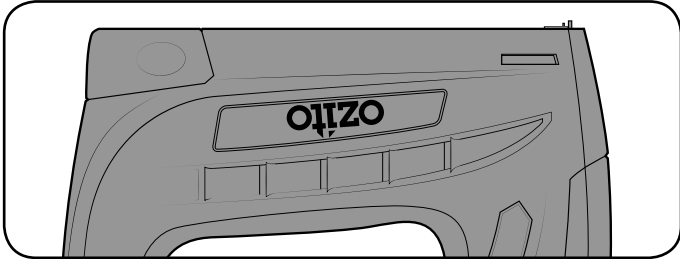

- 2 Squeeze the magazine latches on either side of the tool and pull the magazine out of the tool.

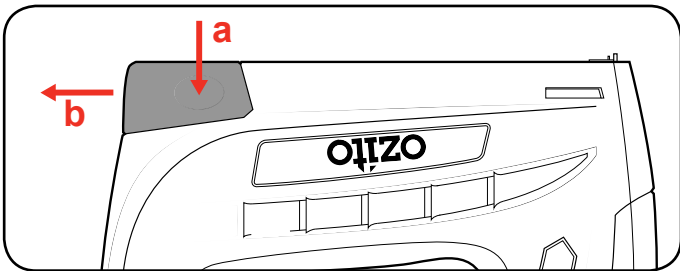

- 3 Insert a row of staples into the opening behind the nose piece.

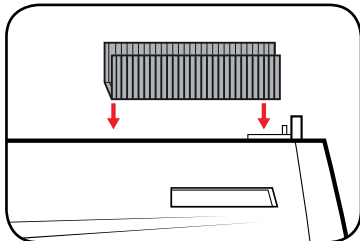

Note: Rows of staples longer than 120mm do not fit in the staple nail gun. Rows of more than 65 staples do not fit in the staple nail gun.

- 4 Push the loaded magazine back into the unit until it clips into place.

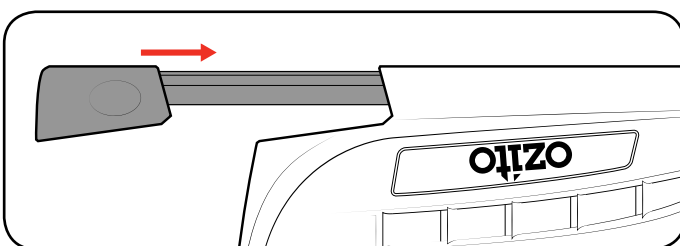

3. LOADING NAILS

This staple nailer only accepts 10mm brad nails. Other types of nails will jam the unit.

- 1 Hold the tool upside down.

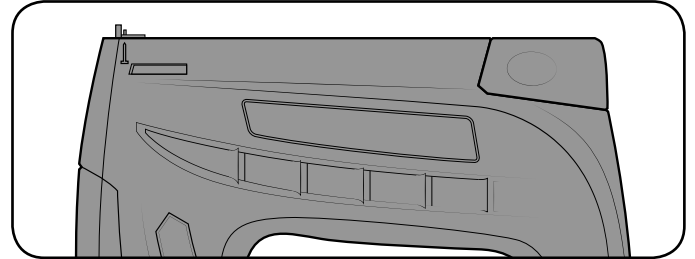

- 2 Squeeze the magazine latches on either side of the tool and pull the magazine out of the tool.

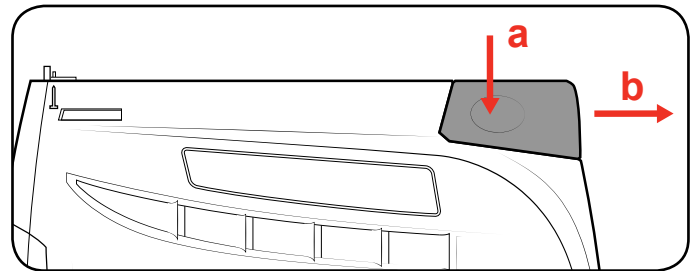

- 3 Insert a row of nails into the opening behind the nose piece. Be sure to align them to the side marked with a nail marker so that the nail head is against the internal groove.

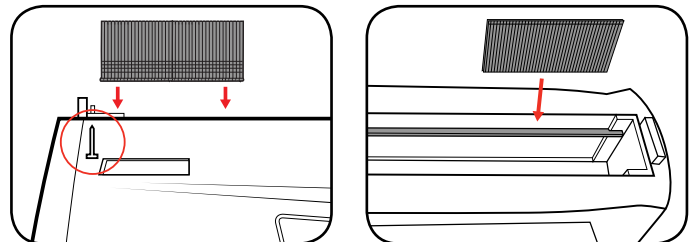

Note: Rows of more than 65 nails do not fit in the staple nail gun.

- 4 Push the loaded magazine back into the unit until it clips into place.

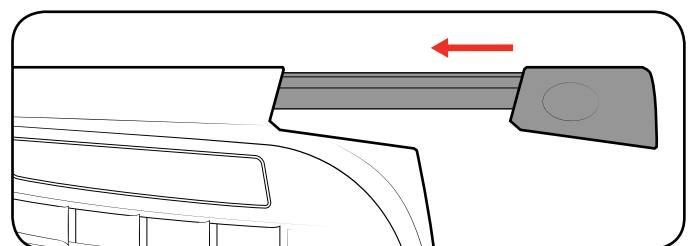

OPERATION

4. CONTROLS

Firing A Staple or Nail

The Safety Striker System is a two step process where a staple or nail will only fire when the safety striker pin is pushed against the material to be fastened.

- 1 Push the safety striker pin and nosepiece down onto the surface to be fastened.

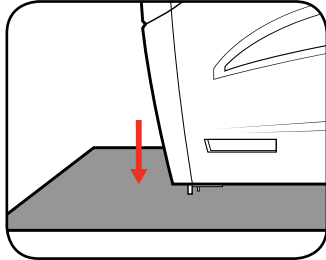

- 2 To fire the staple nail gun, squeeze the on/off trigger.

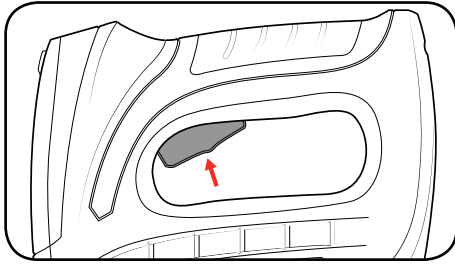

Charge Indicator Light

The charge indicator will illuminate red if the battery is low, indicating that the battery needs charging.

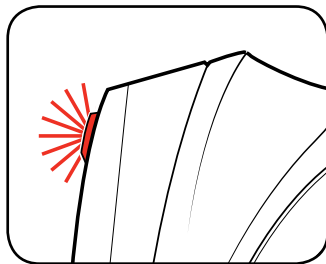

5. TROUBLESHOOTING

Jammed Staple Nail Gun

- 1 Squeeze the magazine latches on either side of the tool and pull the magazine out of the tool.

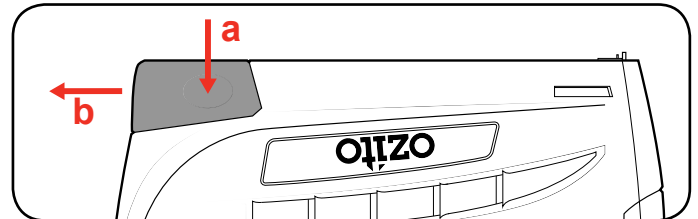

- 2 Using a pair of pliers, remove any jammed staples or nails.

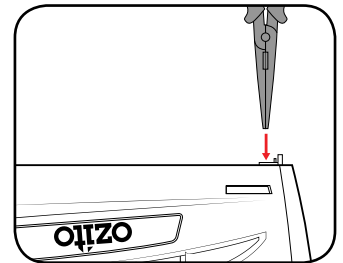

Note: Be careful not to bend the end of the magazine. If this occurs the unit will be inoperable.

- 3 With the magazine still open, tap the safety striker pin against a surface to dislodge any loose staples.

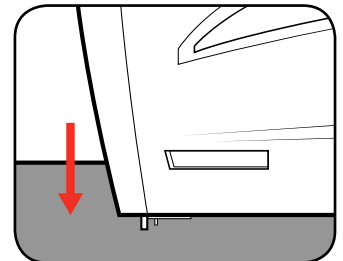

The battery has a short run time

Ensure the battery is properly charged. It will take 4-5 charging cycles before the battery reaches optimum charge and run time.

STAPLE/ NAIL SELECTION

Accessories to suit this Staple Nail Gun can be purchased from Bunnings Warehouse.

Staples	Common Applications for Staple Length
5/16" (8mm)	Insulation, Upholstery, Weather Stripping, Wall Decorations, Crafts, Covering Cornices, Webbing, Light Fabrics.
3/8" (10mm)	Insulation, Carpeting, Wire Mesh, Plastic or Canvas Coverings, Roofing Paper, Felt Stripping, Weather Stripping.
Nails	Common applications: C1 Brads
3/8" (10mm)	Trim Moulding, Panelling, Picture Frames, Model Work, Any Finish Nailing Application.

T50 STAPLE SIZE

The SNL-1000 accepts staples with the below measurements:

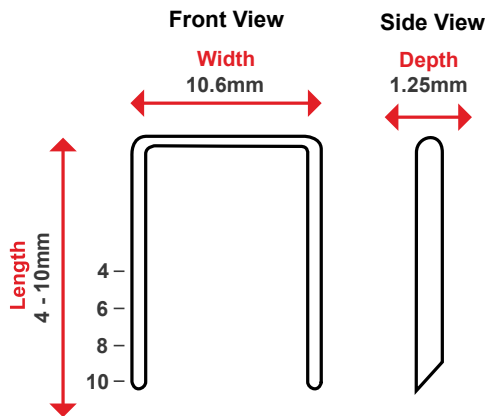

18 GAUGE C1 BRAD NAIL SIZE

The SNL-1000 accepts nails with the below measurements:

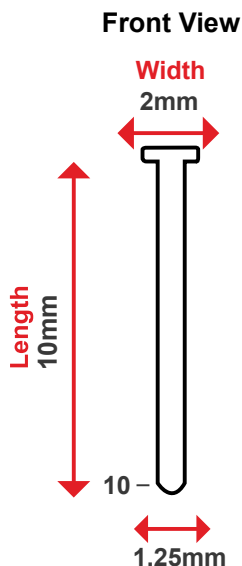

MAINTENANCE

- When not in use, the staple nail gun should be stored in a dry, frost free location, keep out of children's reach.
- If the housing of the staple nail gun requires cleaning, do not use solvents. Use of a cloth only is recommended. Never immerse any part of the staple nail gun into liquid.

Note: Ozito Industries will not be responsible for any damage or injuries caused by repair of the staple nail gun by an unauthorised person or by mishandling.

CARING FOR THE ENVIRONMENT



Power tools that are no longer usable should not be disposed of with household waste but in an environmentally friendly way. Please recycle where facilities exist. Check with your local council authority for recycling advice.



Recycling packaging reduces the need for landfill and raw materials. Reuse of recycled material decreases pollution in the environment. Please recycle packaging where facilities exist. Check with your local council authority for recycling advice.

DESCRIPTION OF SYMBOLS

V	Volts	Hz	Hertz
W	Watts	Ah	Amp hour
dc/---	Direct current	ac/~	Alternating current
	Transformer Energy Rating (MEPS)		Read instruction manual
	Warning		Regulator compliance mark
	Double insulated		Indoor use only
	Thermal cut-out protection		Polarity

SPARE PARTS

Tool: Cordless Staple Nail Gun
Model No. SNL-1000

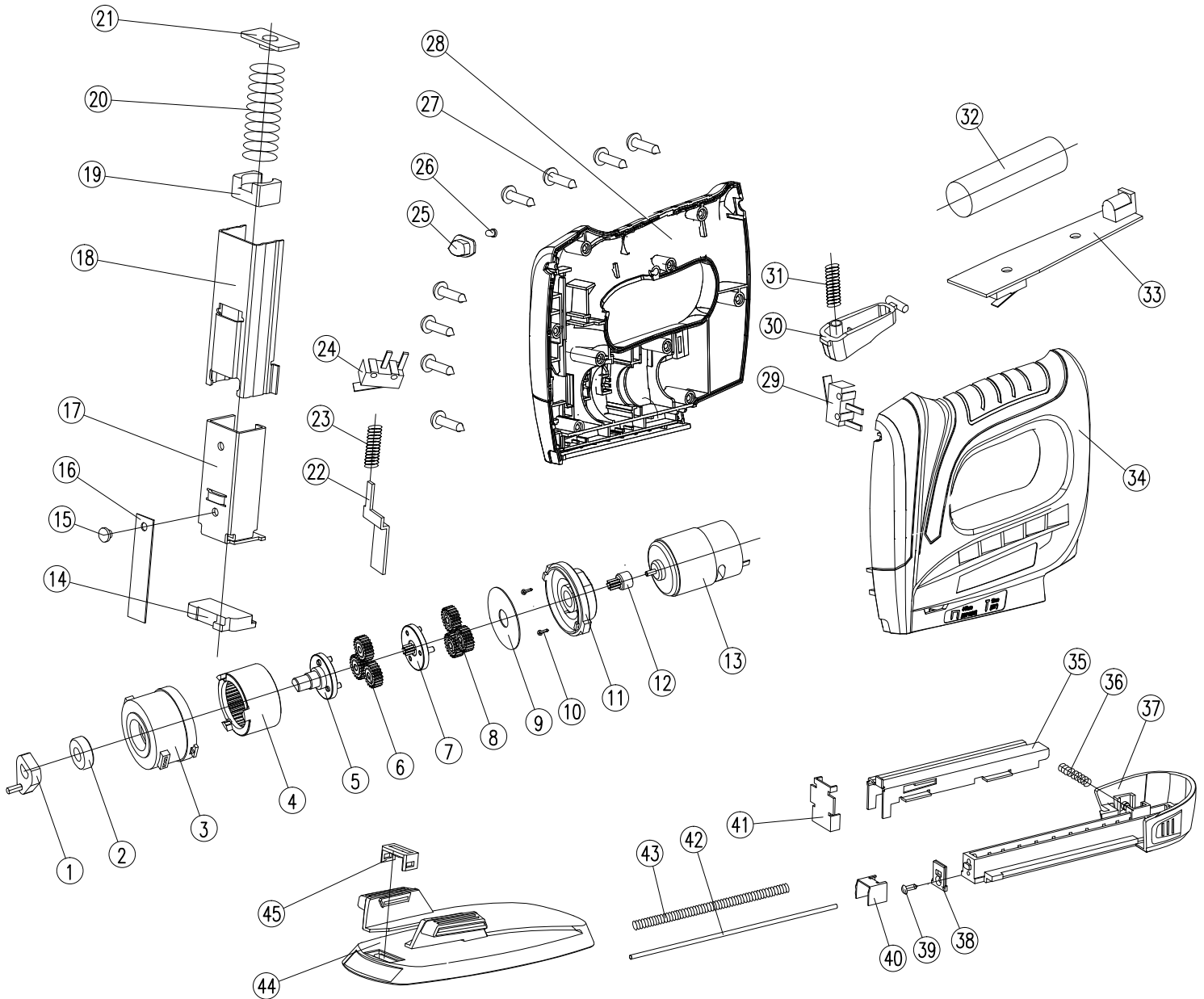

How To Order

Available spare parts can be ordered through the Special Orders Desk at any Bunnings Warehouse. If you have any further questions, please contact Ozito Customer Service on:

Australia: 1800 069 486

New Zealand: 0508 069 486

enquiries@ozito.com.au

ELECTRICAL SAFETY



WARNING! When using mains-powered tools, basic safety precautions, including the following, should always be followed to reduce risk of fire, electric shock, personal injury and material damage.

Read the whole manual carefully and make sure you know how to switch the tool off in an emergency, before operating the tool.

Save these instructions and other documents supplied with this tool for future reference.

The manufacturer cannot accept any liability for damage or accidents which arise due to a failure to follow these instructions and the safety information.

This product has been designed for 230V and 240V only. Always check that the power supply corresponds to the voltage on the rating plate.

Note: The supply of 230V and 240V is interchangeable for Australia and New Zealand.



This charger is double insulated therefore no earth wire is required.

The power supply for this product should be protected by a residual current device (rated at 30mA or less). A residual current device reduces the risk of electric shock.

If the supply cord is damaged, it must be replaced by the manufacturer, its service agent or similarly qualified persons in order to avoid a hazard.

Note: Double insulation does not take the place of normal safety precautions when operating this tool. The insulation system is for added protection against injury resulting from a possible electrical insulation failure within the tool.

GENERAL POWER TOOL SAFETY WARNINGS



WARNING! Read all safety warnings and all instructions. Failure to follow the warnings and instructions may result in electric shock, fire and/or serious injury.

Save all warnings and instructions for future reference. The term "power tool" in the warnings refers to your mains-operated (corded) power tool or battery-operated (cordless) power tool.

1. Work area safety

- Keep work area clean and well lit. Cluttered or dark areas invite accidents.
- Do not operate power tools in explosive atmospheres, such as in the presence of flammable liquids, gases or dust. Power tools create sparks which may ignite the dust or fumes.
- Keep children and bystanders away while operating a power tool. Distractions can cause you to lose control.

2. Electrical safety

- Power tool plugs must match the outlet. Never modify the plug in any way. Do not use any adapter plugs with earthed (grounded) power tools. Unmodified plugs and matching outlets will reduce risk of electric shock.
- Avoid body contact with earthed or grounded surfaces, such as pipes, radiators, ranges and refrigerators. There is an increased risk of electric shock if your body is earthed or grounded.
- Do not expose power tools to rain or wet conditions. Water entering a power tool will increase the risk of electric shock.
- Do not abuse the cord. Never use the cord for carrying, pulling or unplugging the power tool. Keep cord away from heat, oil, sharp edges or moving parts. Damaged or entangled cords increase the risk of electric shock.
- When operating a power tool outdoors, use an extension cord suitable for outdoor use. Use of a cord suitable for outdoor use reduces the risk of electric shock.
- If operating a power tool in a damp location is unavoidable, use a residual current device (RCD) protected supply. Use of an RCD reduces the risk of electric shock.

3. Personal safety

- Stay alert, watch what you are doing and use common sense when operating a power tool. Do not use a power tool while you are tired or under the influence of drugs, alcohol or medication. A moment of inattention while operating power tools may result in serious personal injury.
- Use personal protective equipment. Always wear eye protection. Protective equipment such as dust mask, non-skid safety shoes, hard hat, or hearing protection used for appropriate conditions will reduce personal injuries.
- Prevent unintentional starting. Ensure the switch is in the off-position before connecting to power source and/or battery pack, picking up or carrying the tool. Carrying power tools with your finger on the switch or energising power tools that have the switch on invites accidents.
- Remove any adjusting key or wrench before turning the power tool on. A wrench or a key left attached to a rotating part of the power tool may result in personal injury.
- Do not overreach. Keep proper footing and balance at all times. This enables better control of the power tool in unexpected situations.

- Dress properly. Do not wear loose clothing or jewellery. Keep your hair, clothing and gloves away from moving parts. Loose clothes, jewellery or long hair can be caught in moving parts.
- If devices are provided for the connection of dust extraction and collection facilities, ensure these are connected and properly used. Use of dust collection can reduce dust-related hazards.

4. Power tool use and care

- Do not force the power tool. Use the correct power tool for your application. The correct power tool will do the job better and safer at the rate for which it was designed.
- Do not use the power tool if the switch does not turn it on and off. Any power tool that cannot be controlled with the switch is dangerous and must be repaired.
- Disconnect the plug from the power source and/or the battery pack from the power tool before making any adjustments, changing accessories, or storing power tools. Such preventive safety measures reduce the risk of starting the power tool accidentally.
- Store idle power tools out of the reach of children and do not allow persons unfamiliar with the power tool or these instructions to operate the power tool. Power tools are dangerous in the hands of untrained users.
- Maintain power tools. Check for misalignment or binding of moving parts, breakage of parts and any other condition that may affect the power tool's operation. If damaged, have the power tool repaired before use. Many accidents are caused by poorly maintained power tools.
- Keep cutting tools sharp and clean. Properly maintained cutting tools with sharp cutting edges are less likely to bind and are easier to control.
- Use the power tool, accessories and tool bits etc. in accordance with these instructions, taking into account the working conditions and the work to be performed. Use of the power tool for operations different from those intended could result in a hazardous situation.

5. Battery tool use and care

- Recharge only with the charger specified by the manufacturer. A charger that is suitable for one type of battery pack may create a risk of fire when used with another battery pack.
- Use power tools only with specifically designated battery packs. Use of any other battery packs may create a risk of injury and fire.
- When battery pack is not in use, keep it away from other metal objects, like paper clips, coins, keys, nails, screws or other small metal objects, that can make a connection from one terminal to another. Shorting the battery terminals together may cause burns or a fire.
- Under abusive conditions, liquid may be ejected from the battery; avoid contact. If contact accidentally occurs, flush with water. If liquid contacts eyes, additionally seek medical help. Liquid ejected from the battery may cause irritation or burns.

6. Service

- Have your power tool serviced by a qualified repair person using only identical replacement parts. This will ensure that the safety of the power tool is maintained.

STAPLE NAIL GUN WARNINGS



This appliance is not intended for use by persons (including children) with reduced physical, sensory or mental capabilities, or lack of experience and knowledge, unless they have been given supervision or instruction concerning use of the appliance by a person responsible for their safety.

- Always assume that the tool contains fasteners. Careless handling of the nailer or stapler can result in unexpected firing of fasteners and personal injury.
- Do not point the tool towards yourself or anyone nearby. Unexpected triggering will discharge the fastener causing an injury.
- Do not actuate the tool unless the tool is placed firmly against the workpiece. If the tool is not in contact with the workpiece, the fastener may be deflected away from your target.
- Do not use this nailer or stapler for fastening electrical cables. It is not designed for electric cable installation and may damage the insulation of electric cables thereby causing electric shock or fire hazards.

BATTERY AND CHARGER SAFETY WARNINGS



THIS MANUAL CONTAINS IMPORTANT SAFETY AND OPERATING INSTRUCTIONS FOR YOUR BATTERY CHARGER.

- Before using the charger read all instructions and cautionary markings on the charger, battery pack and the product using the battery pack.
- This charger is not intended for any uses other than charging rechargeable batteries. Any other use may result in risk of fire, electric shock or electrocution.
- Do not place any object on top of the charger or place the charger on a soft surface that may result in excessive internal heat. Place the charger in a position away from any heat source.
- To reduce risk of damage to the electric plug and cord, pull by the plug rather than the cord when disconnecting the charger.
- Make sure the cord is located so that it will not be stepped on, tripped over, or otherwise subjected to damage or stress.
- An extension cord should not be used unless absolutely necessary. Use of an improper extension cord could result in the risk of fire, electric shock or electrocution.
- Do not operate the charger if it has received a sharp blow, been dropped or otherwise damaged in any way. Have it checked by an electrician or power tool repairer.
- Do not disassemble charger. Take it to an electrician or power tool repairer when service or repair is required. Incorrect reassembly may result in a risk of electric shock, electrocution or fire.
- To reduce risk of electric shock, unplug the charger from the outlet before attempting any cleaning. Removing the battery pack will not reduce this risk.
- Never attempt to connect 2 chargers together.
- DO NOT store or use the tool and battery pack in locations where the temperature may reach or exceed 40°C (such as inside sheds or metal buildings in summer).
- The charger is designed to operate on standard household electrical power (240 volts). Do not attempt to use it on any other voltage!
- The battery pack is not fully charged out of the carton. First read the safety instructions and then follow the charging notes and procedures.
- The longest life and best performance can be obtained if the battery pack is charged when the air temperature is between 18 - 24°C. Do not charge the battery pack in an air temperature below 10°C or above 40°C. This is important and will prevent damage to the battery pack.
- Do not incinerate the battery pack even if it is seriously damaged or is completely worn out. The battery can explode in a fire.
- Never attempt to open the battery pack for any reason. If the plastic housing of the battery pack breaks or cracks, immediately discontinue use and do not recharge.
- During charging, the battery must be placed in a well ventilated area.

WARRANTY

IN ORDER TO MAKE A CLAIM UNDER THIS WARRANTY YOU MUST RETURN THE PRODUCT TO YOUR NEAREST BUNNINGS WAREHOUSE WITH YOUR BUNNINGS REGISTER RECEIPT. PRIOR TO RETURNING YOUR PRODUCT FOR WARRANTY PLEASE TELEPHONE OUR CUSTOMER SERVICE HELPLINE:

Australia 1800 069 486

New Zealand 0508 069 486

TO ENSURE A SPEEDY RESPONSE PLEASE HAVE THE MODEL NUMBER AND DATE OF PURCHASE AVAILABLE. A CUSTOMER SERVICE REPRESENTATIVE WILL TAKE YOUR CALL AND ANSWER ANY QUESTIONS YOU MAY HAVE RELATING TO THE WARRANTY POLICY OR PROCEDURE.

The benefits provided under this warranty are in addition to other rights and remedies which are available to you at law.

Our goods come with guarantees that cannot be excluded at law. You are entitled to a replacement or refund for a major failure and for compensation for any other reasonably foreseeable loss or damage. You are also entitled to have the goods repaired or replaced if the goods fail to be of acceptable quality and the failure does not amount to a major failure.

Generally you will be responsible for all costs associated with a claim under this warranty, however, where you have suffered any additional direct loss as a result of a defective product you may be able to claim such expenses by contacting our customer service helpline above.

3 YEAR REPLACEMENT WARRANTY

Your product is guaranteed for a period of **36 months from the original date of purchase** and is intended for DIY (Do It Yourself) use only. If a product is defective it will be replaced in accordance with the terms of this warranty.

Warranty excludes consumable parts, for example: staples, nails, etc.

WARNING

The following actions will result in the warranty being void.

- If the tool has been operated on a supply voltage other than that specified on the tool.
- If the tool shows signs of damage or defects caused by or resulting from abuse, accidents or alterations.
- Failure to perform maintenance as set out within the instruction manual.
- If the tool is disassembled or tampered with in any way.