



18V CORDLESS

BRUSHLESS BELT SANDER SKIN

INSTRUCTION MANUAL

SPECIFICATIONS

Input:	18V
Belt Speed:	120 - 250m/min
Belt Size:	457 x 75 mm
Sanding Surface:	126 x 75mm
Weight:	2.6kg

ozito.com.au

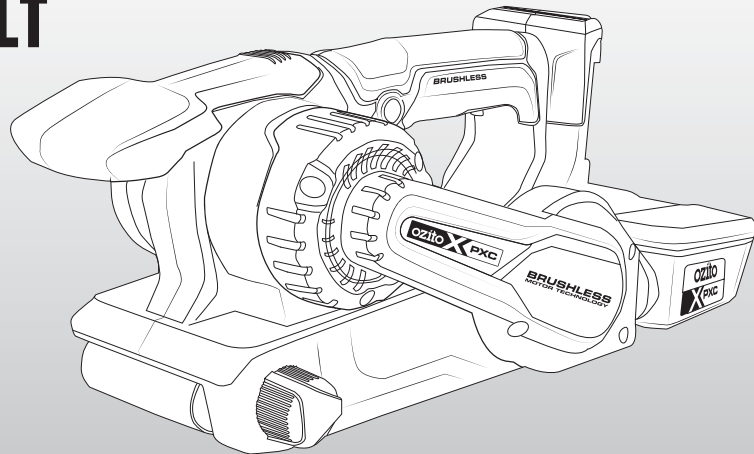

STANDARD EQUIPMENT

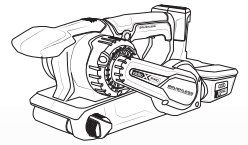

Brushless Belt Sander Skin



Sanding Belt



Dust Canister



Dust Extraction Adapter

5 YEAR
REPLACEMENT WARRANTY

PXBBSS-457

WARRANTY

IN ORDER TO MAKE A CLAIM UNDER THIS WARRANTY YOU MUST RETURN THE PRODUCT TO YOUR NEAREST BUNNINGS WAREHOUSE WITH YOUR BUNNINGS REGISTER RECEIPT. PRIOR TO RETURNING YOUR PRODUCT FOR WARRANTY PLEASE TELEPHONE OUR CUSTOMER SERVICE HELPLINE:

Australia 1800 069 486
New Zealand 0508 069 486

TO ENSURE A SPEEDY RESPONSE PLEASE HAVE THE MODEL NUMBER AND DATE OF PURCHASE AVAILABLE. A CUSTOMER SERVICE REPRESENTATIVE WILL TAKE YOUR CALL AND ANSWER ANY QUESTIONS YOU MAY HAVE RELATING TO THE WARRANTY POLICY OR PROCEDURE.

WARNING

The following actions will result in the warranty being void.

- If the tool has been operated on a supply voltage other than that specified on the tool.
- If the tool shows signs of damage or defects caused by or resulting from abuse, accidents or alterations.
- Failure to perform maintenance as set out within the instruction manual.
- If the tool is disassembled or tampered with in any way.

The benefits provided under this warranty are in addition to other rights and remedies which are available to you at law.

Our goods come with guarantees that cannot be excluded at law. You are entitled to a replacement or refund for a major failure and for compensation for any other reasonably foreseeable loss or damage. You are also entitled to have the goods repaired or replaced if the goods fail to be of acceptable quality and the failure does not amount to a major failure.

Generally you will be responsible for all costs associated with a claim under this warranty, however, where you have suffered any additional direct loss as a result of a defective product you may be able to claim such expenses by contacting our customer service helpline above.

5 YEAR REPLACEMENT WARRANTY

Your Product is guaranteed for a period of 60 months from the original date of purchase and is intended for DIY (Do It Yourself) use only. If a product is defective it will be replaced in accordance with the terms of this warranty. **Lithium Ion batteries and chargers are covered by a 36 month warranty** and are excluded from the warranty extension. Warranty excludes consumable parts.

KNOW YOUR PRODUCT

18V BRUSHLESS BELT SANDER SKIN

- | | |
|-----------------------|----------------------|
| 1. Belt Tracking Knob | 5. Sure Grip Handle |
| 2. Front Handle | 6. Battery Placement |
| 3. On/Off Trigger | 7. Dust Canister |
| 4. Lock On Switch | |

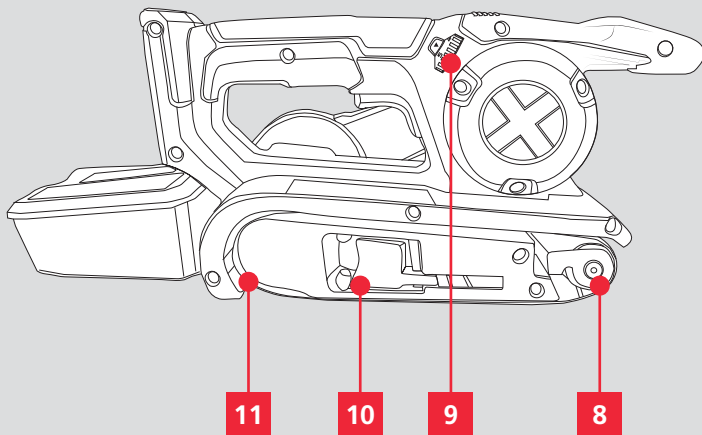
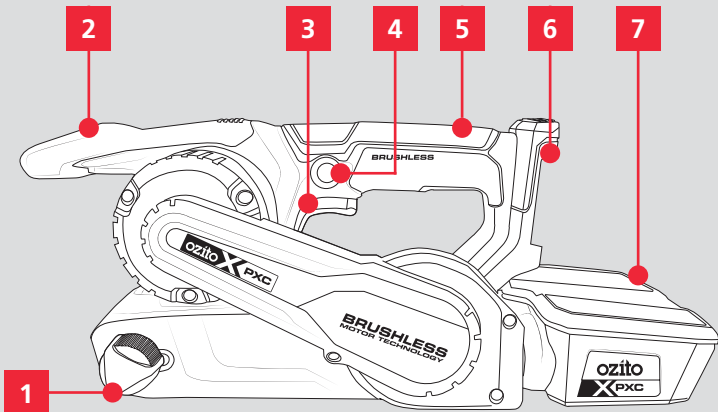

- | | |
|------------------------|---------------------------|
| 8. Front Roller | 10. Tensioning Lever |
| 9. Variable Speed Dial | 11. Sanding Belt (fitted) |

BATTERY & CHARGER

This tool is compatible with all batteries & chargers from the Ozito Power X Change range.

ONLINE MANUAL

Scan this QR Code with your mobile device to take you to the online manual.



SETUP & PREPARATION

1. DUST CANISTER

WARNING! ENSURE THE TOOL IS SWITCHED OFF AND THE BATTERY IS REMOVED BEFORE PERFORMING ANY OF THE FOLLOWING TASKS.

Fitting The Dust Canister

- Slide the dust canister onto the dust ejection port until it is firmly pushed all the way in place.

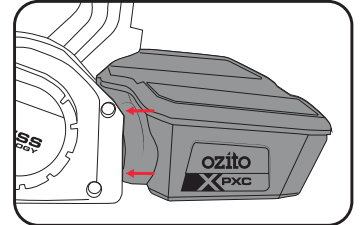

- Ensure the dust canister is closed before starting operation.

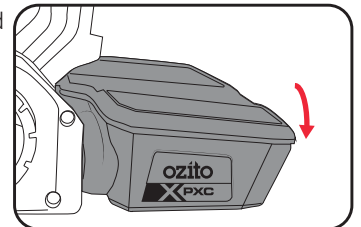

Emptying The Dust Canister

- Remove the dust canister lid and empty the dust into a bin.

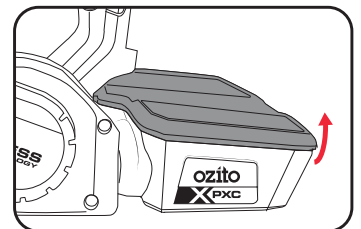

- Ensure the dust canister is closed before starting operation.

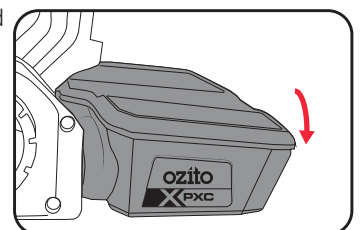

Attaching The Dust Extraction Adapter to the Vacuum

- Remove the dust canister and
 - align the dust extraction adapter
 - align the vacuum head to the dust extraction opening to connect.

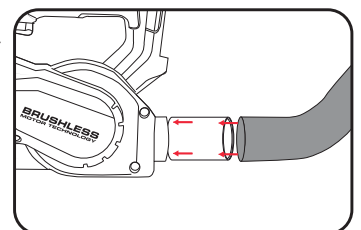

5 YEAR
REPLACEMENT WARRANTY

OPERATION

2. SANDING BELT

Fitting The Sanding Belt

1. Place the sander on its back side

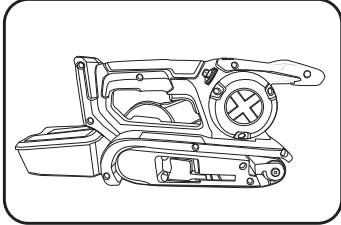

2. Release the belt tension by pushing the tensioning lever all the way towards the front

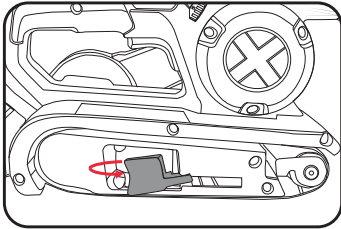

3. Place the belt over the front and rear rollers

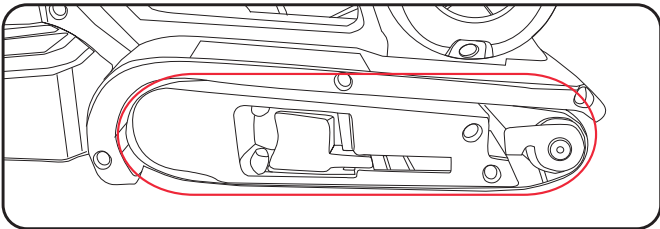

WARNING! THE ARROWS ON THE BELT MUST BE ALIGNED WITH THE MARKINGS ON THE BELT SANDER. INCORRECT FITMENT COULD CAUSE THE BELT TO BREAK. BELTS ARE NOT COVERED BY THE WARRANTY.

4. Once the belt is in the correct position, pull the tensioning lever backwards to secure the belt.

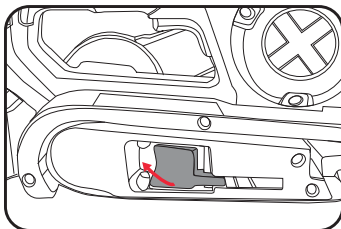

Removing The Sanding Belt

1. Release the belt tension by pushing the tensioning lever all the way towards the front.

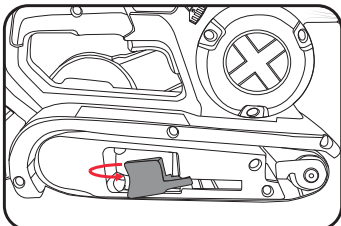

2. Remove the belt from the rollers.

3. BELT ADJUSTMENT

WARNING! DO NOT TOUCH THE RUNNING BELT WHEN BELT ADJUSTMENT IS NECESSARY.

Tracking Adjustment

It is necessary to ensure the belt is tracking correctly, in a straight line, to avoid the belt 'tracking off' the belt sander's rollers.

1. Turn the sander upside down and hold it firmly with one hand.

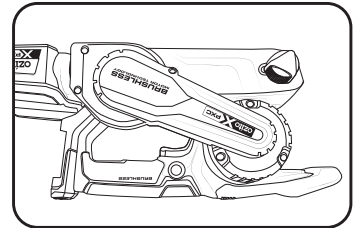

2. Press the on/off trigger to start the sander and observe the tracking of the sanding belt

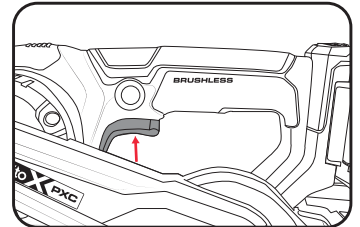

3. If the belt tracks outwards, rotate the tracking knob anti-clockwise. If the belt tracks inward, rotate the knob clockwise

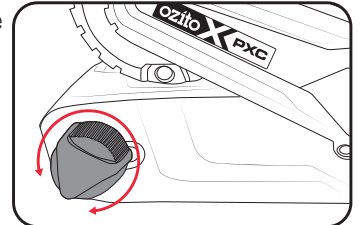

4. Adjust the belt until its outer edge is even with the outer edge of the rear roller. Make sure that the belt does not rub against the rear guide strip.

4. CONTROLS

On/Off Trigger

1. To start the sander, squeeze the on/off trigger.

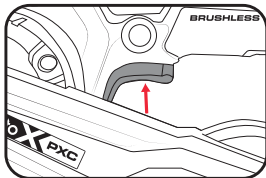

2. To stop operation release the on/off trigger

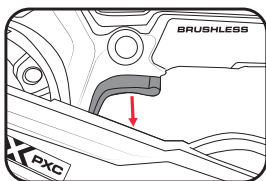

Lock On Button

The PXBBSS-457 is designed with a lock on button which allows you to lock the belt sander on which helps to reduce user fatigue when working for longer periods.

1. To enable the Lock On feature, (a) Press the on/off trigger. (b) Press the lock on button.

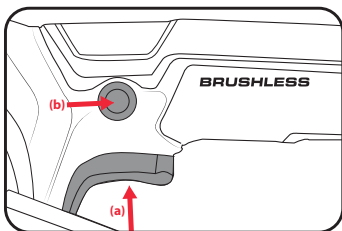

2. Squeeze the on/off trigger again to turn off tool and its lock on the mechanism.

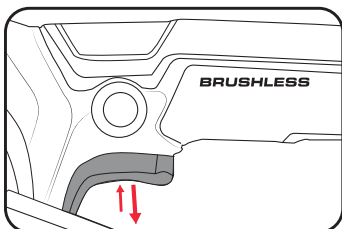

Speed Adjustment

1. To decrease the speed of the tool, rotate the variable speed dial to a lower number (1 being the lowest)

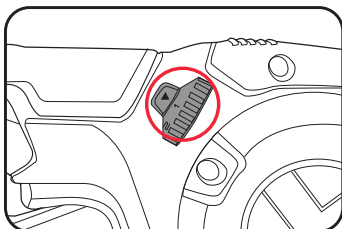

2. To increase the speed of the tool, rotate the variable speed dial to a higher number. (MAX being the highest)

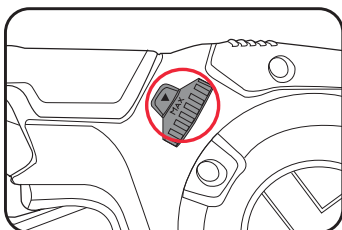

5. SANDING

1. If required, secure the material to be sanded so that it doesn't slip from under the sander.

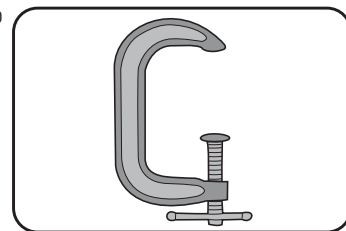

2. Firmly grip the sander and lower the rear heel of the sander onto your workpiece, with the belt off the work surface.

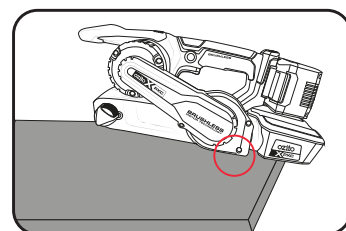

3. Press the on/off trigger and allow the sander to reach maximum speed.

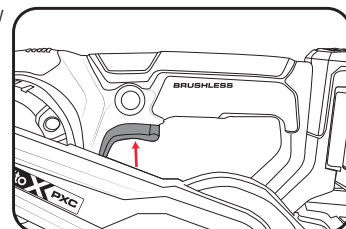

4. Lower the sander onto the workpiece and use a back and forth motion.

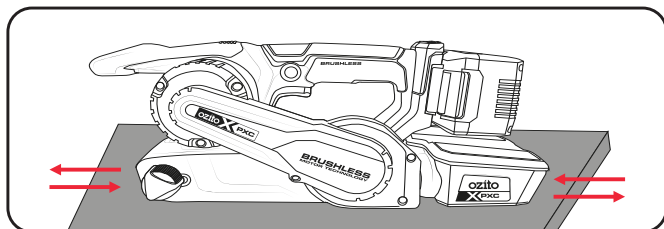

Note:

Do not apply pressure on the sander. Allow the sander to do the work.

Note:

Check your workpiece often. The sander is capable of removing material rapidly, especially with coarse paper.

Note:

Do not sand on one spot for too long. The sander's rapid action may remove too much material, creating an uneven surface..

TROUBLESHOOTING

Belt Sander not sanding

If the belt is no longer sanding, please change the belt.

Sanding Belt out of alignment

If the sanding belt is out of alignment, please adjust following section 3 of the manual.

Loose Belt

If the belt is loose, be sure to check the quick-release is locked on or right size belt is being used.

SANDPAPER SELECTION

Selecting the correct grit of sandpaper is an important step in achieving optimum results. Coarse grit will remove the most material. Finer grit will produce a smoother finish. The condition of the workpiece will determine the grit of the sandpaper to be used. The higher the grit number, the finer the grade of sandpaper.

If the surface is rough, start with a coarse grit and sand until the surface is uniform. Medium grit may then be used to remove scratches left by the coarser grit. Finer grit is then used to finish the surface. Always continue sanding with each grade of sandpaper until the surface is uniform.

MATERIAL	APPROPRIATE GRIT	
	Coarse Sanding	Fine Sanding
Paintwork	180	400
Wood: Softwood	60	240
Hardwood	60	180
Veneer	240	320

Note: If intermediate sanding is required, choose a grit rating between coarse and fine. The above table is intended as a guide only. To ensure a satisfactory result, a small, inconspicuous area should first be tested to ensure the grit of sandpaper chosen is suitable for the desired finish.

SPARE PARTS

Spare parts can be ordered from the Special Orders Desk at your local Bunnings Warehouse.

For further information, or any parts not listed here, visit www.ozito.com.au or contact Ozito Customer Service:

Australia 1800 069 486

New Zealand 0508 069 486

E-mail: enquiries@ozito.com.au

MAINTENANCE



WARNING! BEFORE CLEANING OR CARRYING OUT ANY MAINTENANCE PROCEDURE, ENSURE THAT THE BATTERIES HAVE BEEN REMOVED.

Cleaning

- Keep the ventilation slots of the tool clean at all times to ensure efficient operation.
- After each use, blow air through the tool housing to ensure it is free from all dust, dirt, etc. Build up of dust or dirt particles may cause the tool to overheat and shorten the life of the tool.
- If the housing of the tool requires cleaning, do not use solvents. Use of a cloth only is recommended.
- Never allow any liquid to get inside the tool, never immerse any part of the tool into liquid.

Storage

When not in use, the tool should be stored in a dry, frost free location, keep out of children's reach.

Note: Ozito Industries will not be responsible for any damage or injuries caused by repair of the tool by an unauthorised person or by mishandling.

DESCRIPTION OF SYMBOLS

V	Volts	Ah	Ampere hour
≡	Direct Current	n ₀	No load speed
/min	Revolutions or reciprocations per minute	⚠	Warning
	Wear eye, ear & breathing protection	m/min	Metres per minute
	Regulatory Compliance Mark (RCM)		Read Instruction Manual

CARING FOR THE ENVIRONMENT



Power tools that are no longer usable should not be disposed of with household waste but in an environmentally friendly way. Please recycle where facilities exist. Check with your local council authority for recycling advice.



Recycling packaging reduces the need for landfill and raw materials. Reuse of recycled material decreases pollution in the environment. Please recycle packaging where facilities exist. Check with your local council authority for recycling advice.

ELECTRICAL SAFETY

 **WARNING!** When using electric tools basic safety precautions should always be followed to reduce the risk of fire, electric shock and personal injury.

- Read the whole manual carefully and make sure you know how to switch the tool off in an emergency, before operating the tool. Save these instructions and other documents supplied with this tool for future reference.
- This appliance is not intended for use by persons (including children) with reduced physical, sensory or mental capabilities, or lack of experience and knowledge, unless they have been given supervision or instruction concerning use of the appliance by a person responsible for their safety. Children should be supervised to ensure that they do not play with the appliance.
- This appliance is compatible and only to be used with all batteries & chargers from the Ozito PXC range. Refer to the PXC battery and charger manuals for information regarding charging,

use and storage.

-  **WARNING!** Always remove the battery from the tool:
- when the batteries are to be charged,
 - when the tool is left unattended,
 - when the tool is being checked, cleaned, or having maintenance work done,
 - when the tool is to be stored,
 - or if the tool vibrates abnormally.
- Do not combine different types of batteries or new and used batteries.
 - Do not use modified or damaged batteries.

GENERAL POWER TOOL SAFETY WARNINGS

 **WARNING!** Read all safety warnings, instructions, illustrations and specifications provided with this power tool. Failure to follow all instructions listed below may result in electric shock, fire and/or serious injury.

Save all warnings and instructions for future reference.

The term "power tool" in the warnings refers to your mains-operated (corded) power tool or battery-operated (cordless) power tool.

1) Work area safety

- Keep work area clean and well lit.** Cluttered or dark areas invite accidents.
 - Do not operate power tools in explosive atmospheres, such as in the presence of flammable liquids, gases or dust.** Power tools create sparks which may ignite the dust or fumes.
 - Keep children and bystanders away while operating a power tool.** Distractions can cause you to lose control.
- ## 2) Electrical safety
- Power tool plugs must match the outlet. Never modify the plug in any way. Do not use any adapter plugs with earthed (grounded) power tools.** Unmodified plugs and matching outlets will reduce risk of electric shock.
 - Avoid body contact with earthed or grounded surfaces, such as pipes, radiators, ranges and refrigerators.** There is an increased risk of electric shock if your body is earthed or grounded.
 - Do not expose power tools to rain or wet conditions.** Water entering a power tool will increase the risk of electric shock.
 - Do not abuse the cord. Never use the cord for carrying, pulling or unplugging the power tool. Keep cord away from heat, oil, sharp edges or moving parts.** Damaged or entangled cords increase the risk of electric shock.
 - When operating a power tool outdoors, use an extension cord suitable for outdoor use.** Use of a cord suitable for outdoor use reduces the risk of electric shock.
 - If operating a power tool in a damp location is unavoidable, use a residual current device (RCD) protected supply.** Use of an RCD reduces the risk of electric shock.

3) Personal safety

- Stay alert, watch what you are doing and use common sense when operating a power tool. Do not use a power tool while you are tired or under the influence of drugs, alcohol or medication.** A moment of inattention while operating power tools may result in serious personal injury.
- Use personal protective equipment. Always wear eye protection.** Protective equipment such as a dust mask, non-skid safety shoes, hard hat or hearing protection used for appropriate conditions will reduce personal injuries.
- Prevent unintentional starting. Ensure the switch is in the off-position before connecting to power source and/or battery pack, picking up or carrying the tool.** Carrying power tools with your finger on the switch or energising power tools that have the switch on invites accidents.
- Remove any adjusting key or wrench before turning the power tool on.** A wrench or a key left attached to a rotating part of the power tool may result in personal injury.
- Do not overreach. Keep proper footing and balance at all times.** This enables better control of the power tool in unexpected situations.
- Dress properly. Do not wear loose clothing or jewellery. Keep your hair and clothing away from moving parts.** Loose clothes, jewellery or long hair can be caught in moving parts.
- If devices are provided for the connection of dust extraction and collection facilities, ensure these are connected and properly used.** Use of dust collection can reduce dust-related hazards.
- Do not let familiarity gained from frequent use of tools allow you to become complacent and ignore tool safety principles.** A careless action can cause severe injury within a fraction of a second.

4) Power tool use and care

- Do not force the power tool. Use the correct power tool for your application.** The correct power tool will do the job better and safer at the rate for which it was designed.
- Do not use the power tool if the switch does not turn it on and off.** Any power tool that cannot be controlled with the switch is dangerous and must be repaired.
- Disconnect the plug from the power source and/or remove the battery pack, if detachable, from the power tool before making any adjustments, changing accessories, or storing power tools.** Such preventive safety measures reduce the risk of starting the power tool accidentally.
- Store idle power tools out of the reach of children and do not allow persons unfamiliar with the power tool or these instructions to operate the power tool.** Power tools are dangerous in the hands of untrained users.
- Maintain power tools and accessories. Check for misalignment or binding of moving parts, breakage of parts and any other condition that may affect the power tool's operation. If damaged, have the power tool repaired before use.** Many accidents are caused by poorly maintained power tools.
- Keep cutting tools sharp and clean.** Properly maintained cutting tools with sharp cutting edges are less likely to bind and are easier to control.
- Use the power tool, accessories and tool bits etc. in accordance with these instructions, taking into account the working conditions and the work to be performed.** Use of the power tool for operations different from those intended could result in a hazardous situation.
- Keep handles and grasping surfaces dry, clean and free from oil and grease.** Slippery handles and grasping surfaces do not allow for safe handling and control of the tool in unexpected situations.

5) Battery tool use and care

- Recharge only with the charger specified by the manufacturer.** A charger that is suitable for one type of battery pack may create a risk of fire when used with another battery pack.
 - Use power tools only with specifically designated battery packs.** Use of any other battery packs may create a risk of injury and fire.
 - When battery pack is not in use, keep it away from other metal objects, like paper clips, coins, keys, nails, screws or other small metal objects, that can make a connection from one terminal to another.** Shorting the battery terminals together may cause burns or a fire.
 - Under abusive conditions, liquid may be ejected from the battery; avoid contact. If contact accidentally occurs, flush with water. If liquid contacts eyes, additionally seek medical help.** Liquid ejected from the battery may cause irritation or burns.
 - Do not use a battery pack or tool that is damaged or modified.** Damaged or modified batteries may exhibit unpredictable behaviour resulting in fire, explosion or risk of injury.
 - Do not expose a battery pack or tool to fire or excessive temperature.** Exposure to fire or temperature above 130 °C may cause explosion.
 - Follow all charging instructions and do not charge the battery pack or tool outside the temperature range specified in the instructions.** Charging improperly or at temperatures outside the specified range may damage the battery and increase the risk of fire.
- ## 6) Service
- Have your power tool serviced by a qualified repair person using only identical replacement parts.** This will ensure that the safety of the power tool is maintained.
 - Never service damaged battery packs.** Service of battery packs should only be performed by the manufacturer or authorized service providers.

BRUSHLESS BELT SANDER SAFETY WARNINGS

 **WARNING!** This appliance is not intended for use by persons (including children) with reduced physical, sensory or mental capabilities, or lack of experience and knowledge, unless they have been given supervision or instruction concerning use of the appliance by a person responsible for their safety.

- **Disposing of dust.** Be extremely careful of dust disposal, materials in fine particle form may be explosive. Do not throw sanding dust on an open fire. Spontaneous combustion, may in time, result from a mixture of oil or water with dust particles.
- **Always wear ear, eye protection and a dust mask for dusty applications and when sanding overhead.** Sanding particles can be absorbed by your eyes and inhaled easily and may cause health complications.
- **Use special precautions when sanding chemically pressure treated timber, paint that may be lead based, or any other materials that may contain carcinogens.** A suitable breathing respirator and protective clothing must be worn by all persons entering the work area. Work should be sealed by plastic sheeting and persons not protected should be kept out until work area is thoroughly cleaned.
- **Do not 'wet sand' with this sander.** Liquids entering the motor housing are an electrical shock hazard.
- **Keep fingers and clothing away from belt.** They could get cut or wedged between the pulley, belt and motor housing.
- **Properly adjust the tracking of belt to avoid it overhanging the housing.** A running belt overhanging its housing can cause severe lacerations.

 **WARNING!** Some dust created by power sanding, sawing, grinding, drilling and other construction activities contain chemicals known to cause cancer, birth defects or other reproductive harm.

Some examples of these chemicals are:

- Lead from lead-based paints;
- Crystalline silica from bricks, cement and other masonry products, and;
- Arsenic and chromium from chemically-treated timber.

Your risk from these exposures varies, depending on how often you do this type of work. To reduce your exposure to these chemicals: work in a well ventilated area and work with approved safety equipment, such as dust masks that are specially designed to filter out microscopic particles.