

# LITHIUM-ION CORDLESS DRILL



GB IE

## LITHIUM-ION CORDLESS DRILL

Operation and Safety Notes

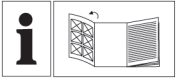

GB IE

Before reading, unfold the page containing the illustrations and familiarise yourself with all functions of the device.

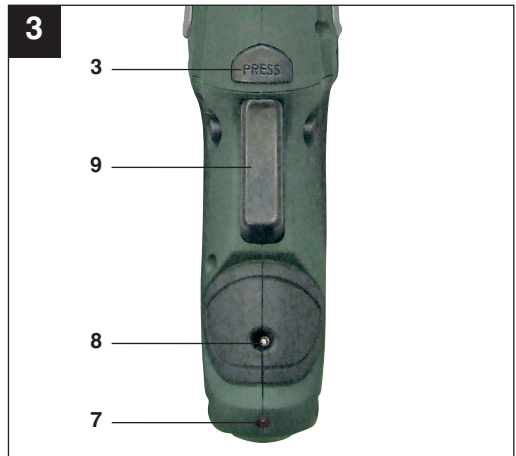

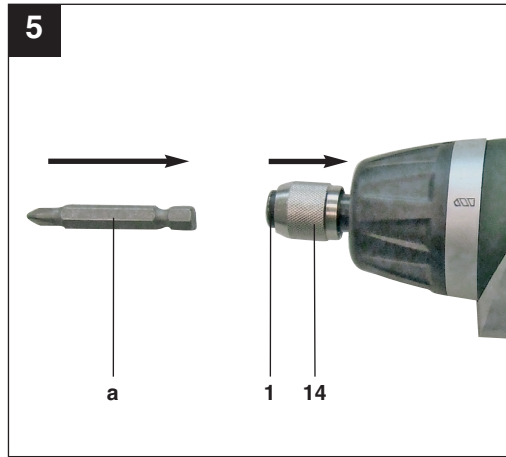



<b>Table of contents:</b>	<b>Page</b>
1. Introduction .....	7
2. Safety regulations .....	7-9
3. Layout .....	10
4. Items supplied.....	10
5. Intended use .....	10
6. Technical data .....	10
7. Before starting the equipment.....	11
8. Operation .....	11-12
9. Cleaning, maintenance and ordering of spare parts .....	12-13
10. Disposal and recycling .....	13
11. Declaration of conformity .....	14
12. Guarantee Certificate .....	15

The reprinting or reproduction by any other means, in whole or in part, of documentation and papers accompanying products is permitted only with the express consent of ISC GmbH.

Technical changes subject to change

GB/  
IE



“Caution - Read the operating instructions to reduce the risk of injury”

## 1. Introduction

### ⚠ Important!

When using equipment, a few safety precautions must be observed to avoid injuries and damage. Please read the complete operating manual with due care. Keep this manual in a safe place, so that the information is available at all times. If you give the equipment to any other person, give them these operating instructions as well. We accept no liability for damage or accidents which arise due to non-observance of these instructions and the safety information.

## 2. Safety regulations

### General safety instructions for electric tools

#### ⚠ CAUTION!

#### Read all safety regulations and instructions.

Any errors made in following the safety regulations and instructions may result in an electric shock, fire and/or serious injury.

#### Keep all safety regulations and instructions in a safe place for future use.

The term "electric tool" used in the safety regulations refers to electric tools operated from the mains power supply (with a power cable) and to battery operated electric tools (without a power cable).

### 1. Workplace safety

- **Keep your work area clean and well illuminated.** Untidy or unlit work areas can result in accidents.
- **Do not use this tool in a potentially explosive environment containing combustible liquids, gases or dust.** Electric tools generate sparks, which can in turn ignite dust or vapors.
- **Keep children and other persons away from the electric tool while it is being used.** Allowing yourself to get distracted can

cause you to lose control of the tool.

## 2. ELECTRICAL SAFETY

- **The tool's connector plug must be able to fit into the socket outlet. Do not modify the plug in any way! Do not use adapter plugs in conjunction with electrically grounded tools.** Unmodified plugs and matching socket outlets reduce the risk of an electric shock.
- **Avoid touching grounded surfaces, such as those of pipes/tubes, heaters, cookers and refrigerators.** There is an increased risk of getting an electric shock if you are electrically grounded.
- **Keep the tool away from rain and moisture/wet conditions.** Penetration of water into an electric tool increases the risk of an electric shock.
- **Do not use the cable to carry the tool, hang it up or pull the plug out of the socket. Keep the cable away from sources of heat, oil, sharp edges and moving tool parts.** Damaged or tangled cable increases the risk of an electric shock.
- **If you intend to use an electric tool outdoors, ensure that you only use extension cable that is approved for outdoor applications.** Using extension cable that is approved for outdoor applications reduces the risk of an electric shock.
- **If operation of the electric tool in a damp environment can not be avoided, use a earth-leakage circuit-breaker.** The earth-leakage circuit-breaker reduces the risk of an electric shock.

## 3. PERSONAL SAFETY

- **Be alert, work conscientiously and exercise appropriate caution when using the electric tool. Do not use the tool if you are tired or are under the influence of drugs/medication or alcohol.** One moment of carelessness or lack of attention when using the electric tool can cause serious bodily injury!

GB/  
IE

- **Always wear personal protective equipment (PPE), including safety goggles.**

Wearing personal protective equipment such as a dust mask, non-slip footwear, protective headgear and ear muffs (depending upon the type of electric tool and the particular application) reduces the risk of sustaining injury.

- **Make sure that the tool cannot start up accidentally. Ensure that the electric tool is switched off before you connect the tool to the power supply and/or insert the battery, or pick up or carry the tool.**

Physically touching the switch with your finger when carrying the tool or connecting the tool to the power supply switched on can lead to accidents.

- **Remove adjusting tools/wrench(es) prior to switching on the power tool.**

A tool or wrench that is positioned inside a rotating power tool part can cause injury.

- **Avoid abnormal working postures. Make sure you stand squarely and keep your balance at all times.**

This way, you will be able to have better control over the tool in unexpected situations.

- **Wear suitable clothes. Never wear loose fitting clothes or jewelry. Keep hair, clothes and gloves away from moving parts.**

Loose clothing, dangling jewelry and long hair can be caught by moving parts.

- **If dust extraction and dust collection devices can be mounted, ensure that these are connected and are properly used.**

The use of a dust extraction system can reduce the danger posed by dust.

#### 4. Using the treatment of electric tools

- **Do not overload your tool. Only use suitable electric tools to perform your work.**

Using the right electric tool allows you to work better and safer within the tool's quoted capacity range.

- **Do not use an electric tool whose switch**

**is defective.**

An electric tool that no longer can be switched on or off is dangerous and must be repaired.

- **Pull the plug out of the socket and/or remove the battery before making any adjustments to the tool, changing accessories or put the tool down.**

This precaution eliminates the possibility of inadvertently starting the tool.

- **When not in use, store electric tools out of the reach of children. Do not allow those persons to use this tool who are unfamiliar with it or who have not read these instructions.**

Electric tools are dangerous when they are used by inexperienced persons.

- **Take good care of your tool. Check that moving parts properly function and do not jam, that parts are not broken off or damaged in any way and that the tool can be used to its full capacity. Have damaged parts repaired prior to using the tool.**

The cause of many accidents can be traced back to poorly maintained electric tools.

- **Keep your blades sharp and clean.**

Properly maintained blades with sharp edges jam less frequently and are easier to use.

- **Make sure to use electric tools, accessories, attachments, etc. in accordance with these instructions.**

**Take the conditions in your work area and the job in hand into account.**

Using electric tools for applications other than those intended can lead to dangerous situations.

#### 5. Usage and treatment of battery powered electric tools

- **Only charge the batteries in chargers that are recommended by the manufacturer.** A charger that is designed for a certain type of batteries may pose a fire risk if it is used with other types of batteries.

- **Use only the correct batteries in the electric tools.** The use of other batteries



may result in injuries and a fire risk.

- **Keep unused batteries away from paper clips, coins, keys, nails, screws and other metallic objects that could cause a short circuit between the contacts.** A short circuit between the battery contacts may cause burns or a fire.
- **In case of incorrect use, fluid may escape from the battery. Avoid contact with it. If you touch it by mistake, rinse the affected area with water. If you get the fluid in your eyes, also seek medical advice.** Leaking battery fluid can cause skin irritation or burns.

## 6. SERVICE

- **Have your tool repaired only by authorized specialists using original replacement parts.**  
This will ensure that your tool remains safe to use.

### Additional safety instructions

- The battery pack supplied with your cordless tool is not charged. The battery pack has to be charged before you use the tool for the first time.
- The battery pack does not reach its maximum capacitance until it has been charged and dis-charged approximately five times.
- Battery packs lose their charge even when they are not being used. Regular charging is therefore recommended.
- Please check the data marked on the rating plate of the battery charger. Be sure to connect the battery charger to a power supply with the voltage marked on the rating plate. Never connect it to a different mains voltage.
- Keep the battery charger and the cordless tool out of children's reach.
- Wear suitable work clothes. Wear safety goggles.
- Never open the battery pack. Avoid contact with a leaking battery pack. In case of accidental contact, wash the affected area of skin with soap and water. If battery acids gets in your eye, rinse out the eye with

clear water for at least 10 minutes and seek a doctor's advice immediately. Neutralize other affected areas with a mild acid such as lemon juice or vinegar.

- Protect the battery charger and its cable from damage and sharp edges. Have damaged cables repaired without delay by a qualified electrician.
- Make sure that the contacts of the battery pack do not come into contact with other metallic objects such as nails or screws. There is a risk of short-circuiting!
- Use only battery chargers that are intended for the battery pack in question.
- Do not use damaged battery chargers.
- Leave repairs strictly to the appointed service center or authorized dealers.
- Do not use the supplied battery charger to charge other cordless tools.
- Never allow the battery pack to become fully discharged. This will cause it to develop a defect.
- Timely recharging of the battery pack will help it serve you well for a long time. You must recharge the battery pack when you notice that the power of the cordless tool drops.
- In heavy use the battery pack will become warm. Allow the battery pack to cool to room temperature before commencing with the charging.
- Protect your cordless tool and the battery charger from moisture and rain.
- Do not use the cordless tool or the battery charger near vapors and inflammable liquids.
- Do not throw battery packs into an open fire. There is a risk of explosion!
- Use the battery charger only in dry conditions and an ambient temperature of 10-40°C.
- Do not keep the battery charger in places where the temperature is liable to reach 50°C. In particular, do not leave the battery charger in a car that is parked in the sunshine.
- Do not ignite the battery pack or expose it to fire.

**Save this instructions.**

GB/  
IE

### 3. Layout (Fig. 1)

1. Bit chuck
2. LED lamp
3. Locking button
4. ON/OFF switch for lamp
5. Battery capacity indicator
6. Button for battery capacity indicator
7. Charging control lamp
8. Charging connection
9. ON/OFF switch
10. Clockwise/Counter-clockwise selector switch
11. Battery charger
12. Charging cable
13. Torque selector
14. Locking sleeve

### 4. Items supplied

Take all parts out of the packaging and check that they are complete.

- Cordless Screwdriver P-AS 3.6 Li
- Battery charger
- 20 Bits
- Bit holder
- Case
- Operating Instructions

### 5. Intended use

The cordless screwdriver is designed for tightening and loosening screws.

The equipment is to be used only for its prescribed purpose. Any other use is deemed to be a case of misuse. The user/operator and not the manufacturer will be liable for any damage or injuries caused as a result thereof.

Please note that our equipment has not been designed for use in commercial, trade or industrial applications. Our warranty will be voided if the equipment is used in commercial, trade or industrial businesses or for equivalent purposes.

### 6. Technical data

Motor power supply:	3.6 V DC
Idling speed:	200 rpm
Clockwise/Counter-clockwise:	Yes
Charge voltage for rechargeable battery:	6 V DC
Charge current for rechargeable battery:	300 mA
Battery charger supply voltage:	230V ~ 50 Hz
Charging time:	3-5,5 hours
Battery type:	Li-Ion
Weight:	0.4 kg
LED Class	1

### Sound and vibration

Sound and vibration values were measured in accordance with EN 60745.

Sound pressure level $L_{pA}$	62 dB(A)
Uncertainty $K_{pA}$	3 dB
Sound power level $L_{WA}$	73 dB(A)
Uncertainty $K_{WA}$	3 dB

#### Wear ear-muffs.

The impact of noise can cause damage to hearing.

Total vibration values (vector sum of three directions) determined in accordance with EN 60745.

#### Screws without hammer action

Vibration emission value  $a_h \leq 2.5 \text{ m/s}^2$   
Tolerance  $K = 1.5 \text{ m/s}^2$

#### ⚠ Caution:

The vibration value changes according to the area of application of the electric tool and may exceed the specified value in exceptional circumstances.

## 7. Before starting the equipment

### ⚠ Caution:

Be sure to read the following information before you use your cordless screwdriver for the first time:

1. Only charge the battery pack using the charger supplied.
2. Only use screwdriver bits which are in perfect working order and appropriate.
3. When screwing into walls or partitions, test these for electrical, gas or water connections.

## 8. Operation

### 8.1 Charging the battery pack (Fig. 1)

The battery pack is protected from exhaustive discharge. An integrated protective circuit automatically switches off the equipment when the battery pack is flat. In this case the bit chuck (1) will cease to turn.

### ⚠ Caution:

Do not press the ON/OFF switch (9) any more, if the protective circuit has actuated. This may damage the battery pack.

1. Check that your mains voltage is the same as the voltage indicated on the rating plate of the battery charger. Plug the battery charger (11) in the plug socket and connect the charging cable (12) to the charging connection (8). The charging process starts as soon as the charging cable is connected to the charging adapter.
2. The charging control lamp (7) indicates that the battery is being charged.
3. The charging control lamp (7) goes out when charging is completed.

### ⚠ Caution:

The handle may become a little warm during the charging process. This is normal.

If the battery pack fails to charge, please check

- whether there is voltage at the socket-outlet.
- whether there is good contact at the charging contacts of the battery charger (11).

If the battery still fails to charge, send

- the battery charger (11)
- and the screwdriver

to our customer services department.

Timely recharging of the battery pack will help to prolong its lifespan. You must recharge the battery pack when you notice that the power of the screwdriver drops.

### 8.2 Clockwise/Counter-clockwise selector switch (Fig.2/Item 10)

The slide switch (10) above the ON/OFF switch (9) is for setting the direction of rotation of the cordless screwdriver and for preventing the cordless screwdriver from being switched on inadvertently. You can select between clockwise and counter-clockwise rotation.

### ⚠ Caution:

Change the direction of rotation only when the equipment is at a standstill. If you fail to observe this point, the gearing may become damaged. When the slide switch (10) is in the middle position, the ON/OFF switch (9) is blocked.

#### Direction

Clockwise  
Counter-clockwise

#### Switch position

"F" pressed  
"R" pressed

### 8.3 ON/OFF switch (Fig. 2 / Item. 9)

Press the On/Off switch to switch the cordless screwdriver on. Release the ON/OFF switch to switch off.

### 8.4 LED lamp (Fig. 1/Item 2)

The LED lamp (2) can be used in poor lighting conditions to illuminate the area where you want to screw. To switch ON, press the switch (4) and to switch OFF, press the switch (4) again.

GB/  
IE**8.5 Handle adjustment (Fig. 1.2/Item 3)**

The screwdriver can be locked into 2 different angle settings. To do so, press the locking button (3) and move the screwdriver into the desired position. Then release the locking button (3).

**⚠ Caution:**

Before you switch on the screwdriver, make sure that it is correctly locked in the required angle position.

**8.6 Battery capacity indicator (Fig. 4/Item. 5)**

Press the button for the battery capacity indicator (6). The battery capacity indicator (5) indicates the charge state of the battery on 3 coloured LEDs.

**All LEDs are lit:**

The battery is fully charged.

**The yellow and red LED illuminate:**

The battery has an adequate remaining charge.

**Red LED:**

The battery is discharged, it requires charging.

**8.7 Changing the tool (Fig. 5)****⚠ Caution:**

Adjust the switch (10) to the middle setting when carrying out work on the cordless screwdriver (Changing the tool; Maintenance; etc.).

- Pull back and hold the locking sleeve (14).
- Insert the bit (a) into the bit chuck (1) and let go of the locking sleeve (14)
- Check that it is properly secure by pulling the tool.
- For removal of bits (a), pull back the locking sleeve (14) and hold it firmly.
- Remove the bit (a) and let go of the locking sleeve.

**8.8 Torque Setting (Fig. 1/Item 13)**

The cordless screwdriver is fitted with a mechanical torque selector.

The torque for each particular screw size is adjustable at the torque selector (13). The required torque is dependent upon several factors:

- the type and hardness of the material to be worked with.
- the type and length of the screws used.
- the physical burden placed on the screw connection.

When the torque is reached, this is indicated by the clutch being released.

**⚠ Caution:**

Only adjust the torque when the appliance is at a standstill.

**8.9 Screws**

It is advisable to use self-centering screws (e.g. Torx, Philips head screws) as these will enable you to work safely and reliably. Always make sure that the bit used is of the same size and shape as the screw.

**8.10 Screwdriver overloaded**

If the screwdriver is overloaded, the automatic safety switch turns the device off. After a few seconds the screwdriver can be used again.

**9. Cleaning, maintenance and ordering of spare parts****⚠ Caution:**

Always pull out the mains power plug before starting any cleaning work.

**9.1 Cleaning**

- Keep all safety devices, air vents and the motor housing free of dirt and dust as far as possible. Wipe the appliance with a clean cloth or blast it with compressed air at low pressure.
- We recommend cleaning the appliance immediately after every use.

- Clean the appliance regularly with a damp cloth and some soft soap. Do not use cleaning agents or solvents; these may be aggressive to the plastic parts in the appliance. Ensure that no water can get into the interior of the tool.

## 9.2 Maintenance

There are no other parts inside the equipment which require additional maintenance.

## 9.3 Ordering replacement parts:

Please provide the following information on all orders for spare parts:

- Model/type of the equipment
- Article number of the equipment
- ID number of the appliance

For our latest prices and information please go to [www.isc-gmbh.info](http://www.isc-gmbh.info)

## 10. Disposal and recycling

The equipment is supplied in packaging to prevent it from being damaged in transit. The raw materials in this packaging can be reused or recycled. The appliance and its accessories are made of various types of material, such as metal and plastic. Defective components must be disposed of as special waste. Ask your dealer or your local council.

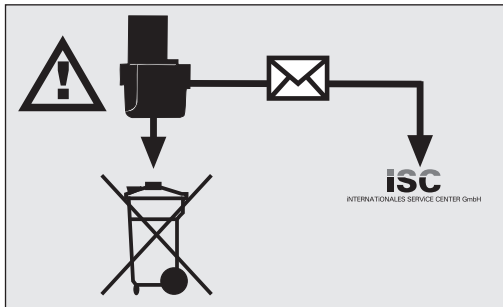

Accumulators and battery-powered electrical appliances contain materials which are harmful to the environment. Do not dispose of battery powered appliances in normal household refuse. If the appliance has a fault or shows wear, remove the battery and send to iSC

GmbH, Eschenstraße 6, D-94405 Landau, or if inseparable, send the battery pack. There, the manufacturer will dispose of the batteries in a professionally appropriate manner.



For EU countries only

Never place any electric tools in your household refuse.

To comply with European Directive 2002/96/EC concerning old electric and electronic equipment and its implementation in national laws, old electric tools have to be separated from other waste and be disposed of in an environment-friendly fashion, e.g. by taking to a recycling depot.

Recycling alternative to returning the electrical equipment:

The owner of the electrical equipment is obligated to arrange for its proper disposal if he no longer wants to keep the equipment in his possession and does not want to return it. In this case the old equipment can be taken to a recycling depot where it is disposed of in accordance with national recycling and waste disposal laws. This does not apply to accessory parts and aids which supplement the old equipment and contain no electrical parts.

GB/  
IE

## 11. Declaration of conformity



## Konformitätserklärung

Einhell Germany AG · Wiesenweg 22· D-94405 Landau/Isar

**D** erklärt folgende Konformität gemäß EU-Richtlinie und Normen für Artikel  
**GB** declares conformity with the EU Directive and standards marked below for the article  
**F** déclare la conformité suivante selon la directive CE et les normes concernant l'article  
**NL** verklaart de volgende conformiteit in overeenstemming met de EU-richtlijn en normen voor het artikel  
**E** declara la siguiente conformidad a tenor de la directiva y normas de la UE para el artículo  
**P** declara a seguinte conformidade de acordo com a directiva CE e normas para o artigo  
**S** förklarar följande överensstämmelse enl. EU-direktiv och standarder för artikeln  
**FIN** ilmoittaa seuraavaa Euroopan unionin direktiivien ja normien mukaista yhdenmukaisuutta tuotteelle  
**HU** erklærer herved følgende samsvar med EU-direktiv og standarder for artikkel  
**BS** заявляє о соответствии товара следующим директивам и нормам ЕС  
**HR** izjavljuje sljedeću uskladenost s odredbama i normama EU za artikl.  
**RO** declară următoarea conformitate cu linia directoare CE și normele valabile pentru articolul.  
**TR** ürün ile ilgili olarak AB Yönetmelikleri ve Normları gereğince aşağıdaki uygunluk açıklama masını sunar.  
**GR** δηλώνει την ακόλουθη συμφωνία σύμφωνα με την Οδηγία ΕΕ και τα πρότυπα για το προϊόν

**I** dichiara la seguente conformità secondo la direttiva UE e le norme per l'articolo  
**GB** attesterer følgende overensstemmelse i henhold til EU-direktiv og standarder for produkt  
**CZ** prohlašuje následující shodu podle směrnice EU a norem pro výrobek.  
**H** a következő konformitást jelenti ki a termékek-re vonatkozó EU-irányvonalak és normák szerint  
**SK** pojednává s nasledujúcou skladnosťou podľa smernice EU in normah za artikel.  
**PL** deklaruje zgodność wymienionego ponizej artykułu z następującymi normami na podstawie dyrektywy WE.  
**SK** vydáva nasledujúce prehlásenie o zhode podľa smernice EU a noriem pre výrobok.  
**BG** декларира следното съответствие съгласно директивите и нормите на ЕС за продукта.  
**UKR** заявляє про відповідність згідно з Директивою ЄС та стандартами, чинними для даного товару  
**EE** deklareerib vastavuse järgnevalele EL direktiivi dele ja normidele  
**LT** deklaruoja atitiktį pagal ES direktyvas ir normas  
**LV** izjāvlūje sledeči konformitēt u skladu s odred bom EZ i normāma za artikl  
**RS** Atbilstības sertifikāts apliecina zemāk minēto preču atbilstību ES direktīvām un standartiem  
**LV** Samræmisýfirlýsing staðfestir eftirfarandi samræmi samkvæmt reglum Evrópubandalagsins og stöðlum fyrir vörur

## Akkuschrauber P-AS 3,6 Li / Ladegerät P-AS 3,6 Li-UK

<input checked="" type="checkbox"/>	98/37/EC	<input type="checkbox"/>	87/404/EEC
<input checked="" type="checkbox"/>	2006/95/EC	<input type="checkbox"/>	R&TTED 1999/5/EC
<input type="checkbox"/>	97/23/EC	<input type="checkbox"/>	2000/14/EG_2005/88/EC:
<input checked="" type="checkbox"/>	2004/108/EC	<input type="checkbox"/>	95/54/EC:
<input type="checkbox"/>	90/396/EEC	<input type="checkbox"/>	97/68/EC:
<input type="checkbox"/>	89/686/EEC		

**EN 60745-1; EN 60745-2-2; EN 55014-1; EN 55014-2;  
EN 60335-2-29; EN 60335-1; EN 61000-3-2; EN 61000-3-3**

Landau/Isar, den 20.01.2009

  
 Weichselgartner  
 General-Manager

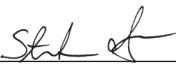
  
 Mayr  
 Product-Management

 Art.-Nr.: 45.134.18 I.-Nr.: 01019  
 Subject to change without notice

Archivierung: 4513385-47-4155050-08

# 12. GUARANTEE CERTIFICATE

## Dear Customer,

All of our products undergo strict quality checks to ensure that they reach you in perfect condition. In the unlikely event that your device develops a fault, please contact our service department at the address shown on this guarantee card. Of course, if you would prefer to call us then we are also happy to offer our assistance under the service number printed below. Please note the following terms under which guarantee claims can be made:

1. These guarantee terms cover additional guarantee rights and do not affect your statutory warranty rights. We do not charge you for this guarantee.
2. Our guarantee only covers problems caused by material or manufacturing defects, and it is restricted to the rectification of these defects or replacement of the device. Please note that our devices have not been designed for use in commercial, trade or industrial applications. Consequently, the guarantee is invalidated if the equipment is used in commercial, trade or industrial applications or for other equivalent activities. The following are also excluded from our guarantee: compensation for transport damage, damage caused by failure to comply with the installation/assembly instructions or damage caused by unprofessional installation, failure to comply with the operating instructions (e.g. connection to the wrong mains voltage or current type), misuse or inappropriate use (such as overloading of the device or use of non-approved tools or accessories), failure to comply with the maintenance and safety regulations, ingress of foreign bodies into the device (e.g. sand, stones or dust), effects of force or external influences (e.g. damage caused by the device being dropped) and normal wear resulting from proper operation of the device. This applies in particular to rechargeable batteries for which we nevertheless issue a guarantee period of 12 months.

The guarantee is rendered null and void if any attempt is made to tamper with the device.

3. The guarantee is valid for a period of 3 years starting from the purchase date of the device. Guarantee claims should be submitted before the end of the guarantee period within two weeks of the defect being noticed. No guarantee claims will be accepted after the end of the guarantee period. The original guarantee period remains applicable to the device even if repairs are carried out or parts are replaced. In such cases, the work performed or parts fitted will not result in an extension of the guarantee period, and no new guarantee will become active for the work performed or parts fitted. This also applies when an on-site service is used.
4. In order to assert your guarantee claim, please send your defective device postage-free to the address shown below. Please enclose either the original or a copy of your sales receipt or another dated proof of purchase. Please keep your sales receipt in a safe place, as it is your proof of purchase. It would help us if you could describe the nature of the problem in as much detail as possible. If the defect is covered by our guarantee then your device will either be repaired immediately and returned to you, or we will send you a new device.

Of course, we are also happy offer a chargeable repair service for any defects which are not covered by the scope of this guarantee or for units which are no longer covered. To take advantage of this service, please send the device to our service address.

**Einhell UK Ltd**  
Morpeth Wharf · Twelve Quays  
Birkenhead, Wirral  
CH41 1NG  
Tel. 0151 6491500 · Fax 0151 6491501

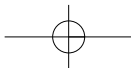



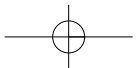



IAN: 30423

**Einhell Germany AG**

Wiesenweg 22

D-94405 Landau/Isar

Last Information Update: 04/2009 · Ident.-No.: 45.134.18.042009-6

