

GENERATOR



P-SE 2800

PARKSIDE

GB IE CY

GENERATOR

Operation and Safety Notes

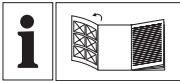

GB IE CY

Before reading, unfold the page containing the illustrations and familiarise yourself with all functions of the device.

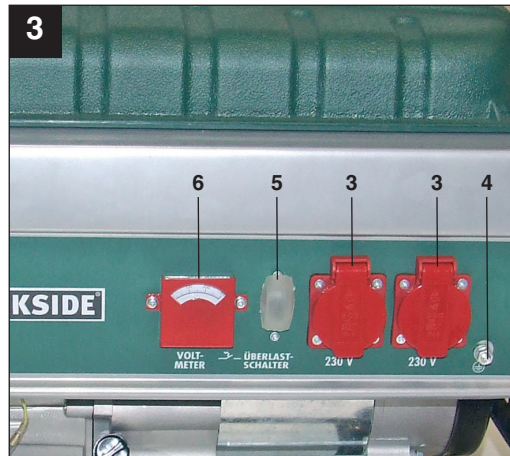
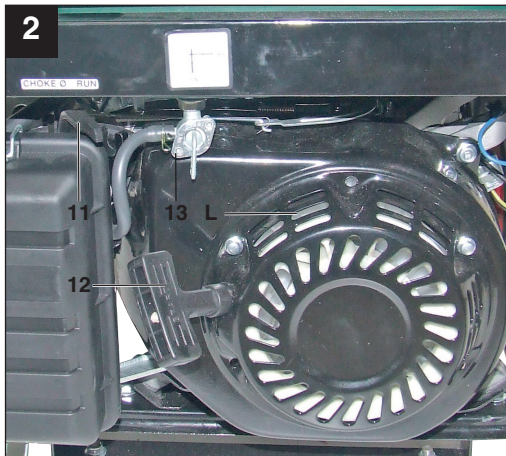

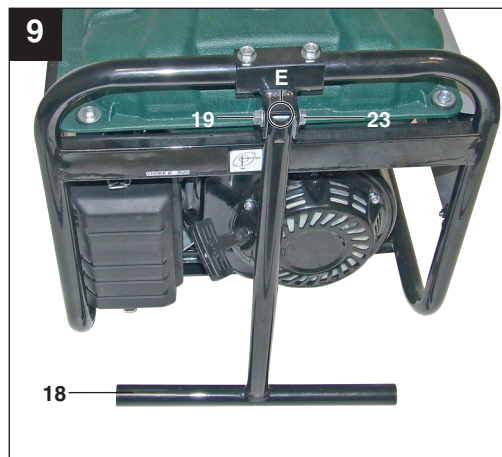
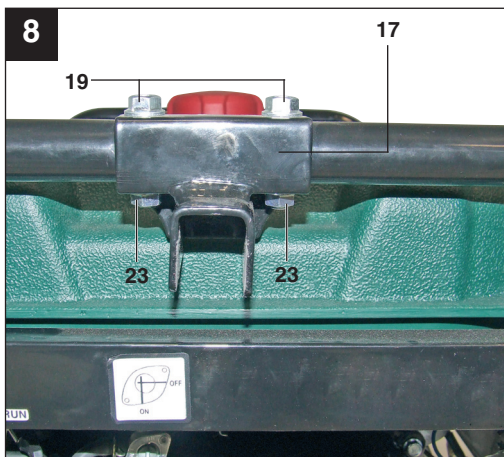
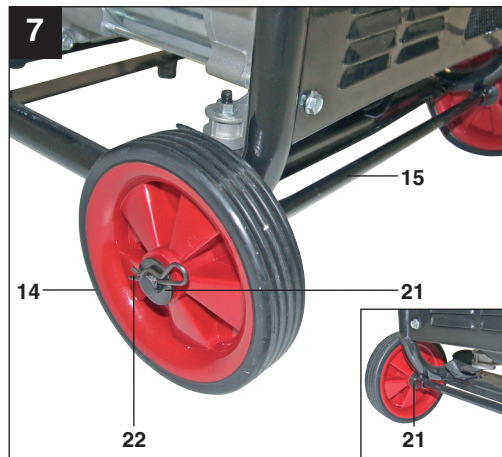
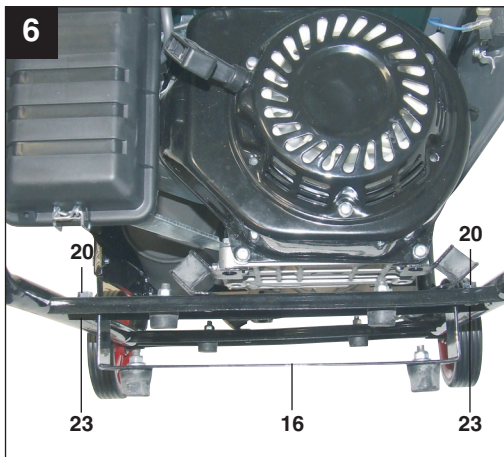
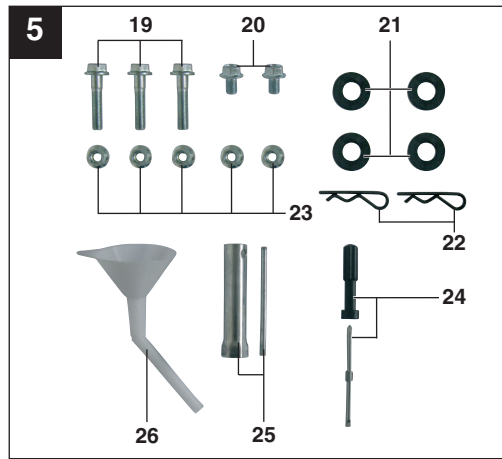
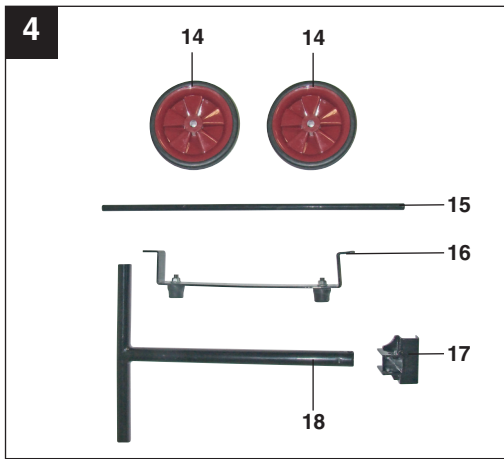

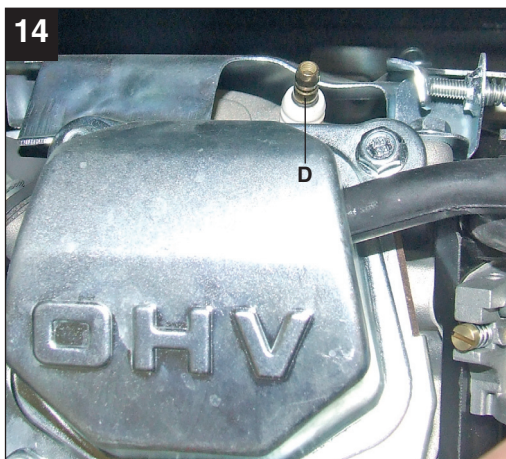
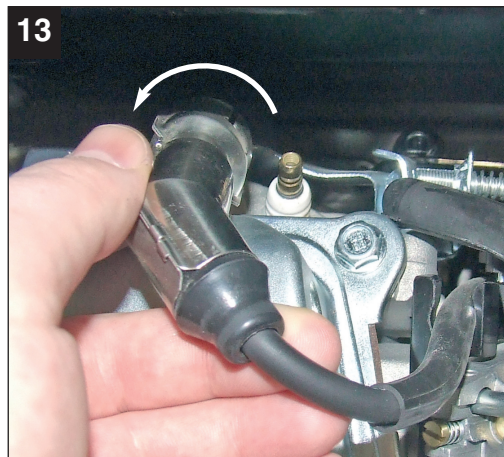
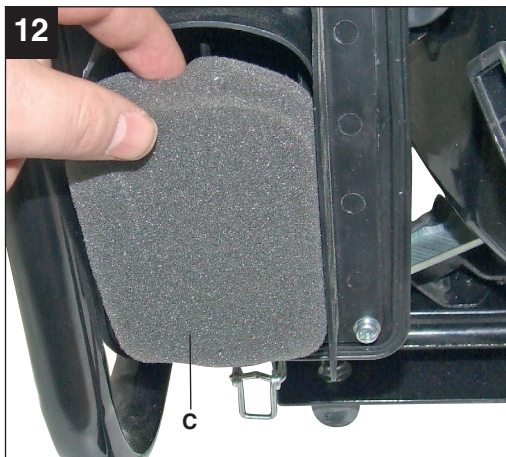
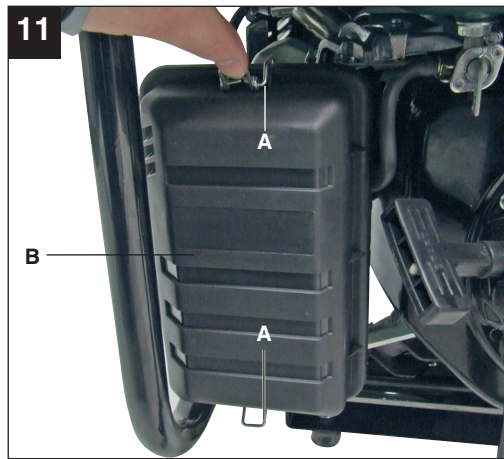
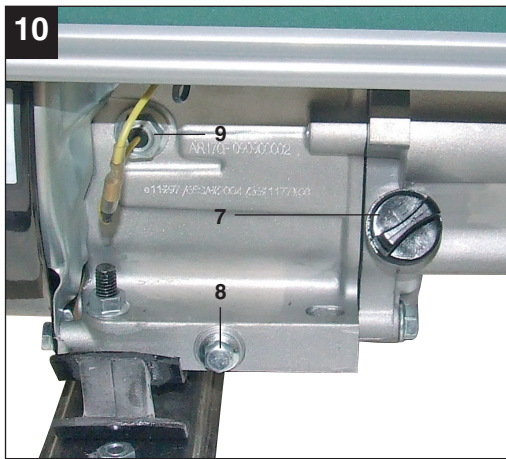

15



1

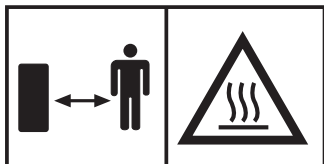

2

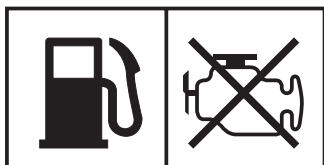

3



4

Table of contents	Page
1. Introduction	8
2. Safety Information	8-9
3. Layout	9
4. Intended use	9
5. Technical data.....	10
6. Before starting the equipment	10
7. Operation	11
8. Cleaning, maintenance, storage, transport and ordering of spare parts	12-13
9. Disposal and recycling	13
10. Troubleshooting guide	14
11. Maintenance schedule	15
12. Declaration of conformity	16
13. Guarantee certificate	17

The reprinting or reproduction by any other means, in whole or in part, of documentation and papers accompanying products is permitted only with the express consent of the ISC GmbH.

Subject to technical changes

1. Introduction

⚠ Important.

When using the equipment, a few safety precautions must be observed to avoid injuries and damage. Please read the complete operating instructions and safety information with due care. Keep this manual in a safe place so that the information is available at all times. If you give the equipment to any other person, hand over these operating instructions and the safety information as well. We cannot accept any liability for damage or accidents which arise due to a failure to follow these instructions and the safety information.

2. Safety Information

- No changes may be made to the generator.
- Only original parts may be used for maintenance and accessories.
- Important: Danger of poisoning. Emissions, fuels and lubricants are toxic. Do not inhale emissions.
- Children are to be kept away from the generator.
- Important: Risk of burns. Do not touch the exhaust system or drive unit.
- Wear suitable ear protection when in the vicinity of the equipment.
- Important: Petrol and petrol fumes are highly combustible or explosive.
- Never operate the generator in non-ventilated rooms or in a highly inflammable environment. If you intend to operate the generator in rooms with good ventilation, the exhaust gases must be channeled directly outdoors through an exhaust hose. Important: Toxic exhaust gases can escape despite the exhaust hose. Due to the fire hazard, never direct the exhaust hose towards inflammable materials.
- Risk of explosion: Never operate the generator in rooms with combustible materials.
- The speed preset by the manufacturer is not allowed to be changed. The generator or connected equipment may be damaged.
- Secure the generator against shifting and toppling during transport.
- Place the generator at least 1m away from walls and equipment connected to them.
- Place the generator in a secure, level position. Do not turn, tip or change the generator's position while it is working.
- Always switch off the engine when transporting and refueling the generator.
- Make sure that when you refuel the generator no fuel is spilt on the engine or exhaust pipe.
- Never operate the generator in rain or snow.
- Never touch the generator with wet hands.
- Guard against electric danger.
- When working outdoors, use only extension cables that are approved for outdoor use and which are marked accordingly (H07RN..).
- The overall length of the extension cables used is not allowed to exceed 50 m for 1.5 mm² and 100 m for 2.5 mm².
- No changes may be made to the settings of the motor or generator.
- Repairs and adjustment work may only be carried out by authorized trained personnel.
- Do not refuel or empty the tank near open lights, fire or sparks. Do not smoke!
- Do not touch any mechanically driven or hot parts. Do not remove the safety guards.
- Do not expose the equipment to damp or dust. Permissible ambient temperature -10 to +40°, altitude: 1000 m above sea level, relative humidity: 90 % (non-condensing)
- The generator is driven by a combustion engine, which produces heat in the range of the exhaust (on the opposite side of the socket) and exhaust outlet. You should therefore avoid coming near these surfaces because of risk of skin burns.
- The values quoted in the technical data under sound power level (LWA) and sound pressure level (LpA) are emission values and not necessarily reliable workplace values. As there is a correlation between emission and immission levels, the values cannot be taken to reliably determine the possible need for additional precautions. Factors influencing the current immission level of the user/operator include the

properties of the work area, other sound sources etc., e.g. the number of machines and other neighboring processes, and the time span over which the user/operator is subjected to the noise. Also, the permitted immission level can vary from country to country. Nevertheless, this information makes it possible for the user to be able to make a better assessment of the dangers and risks involved.

Important: Use only normal, unleaded petrol as fuel.

⚠ CAUTION

Read all the safety regulations and instructions. Any errors made in following the safety regulations and instructions may result in an electric shock, fire and/or serious injury.

Keep all safety regulations and instructions in a safe place for future use.

Explanation of the warning signs on the equipment (Fig. 15)

1. **Important.** Read the operating instructions.
2. **Important.** Hot parts. Keep your distance.
3. **Important.** Switch off the engine before refueling.
4. **Important.** Never operate in non-ventilated rooms.

3. Layout (Fig. 1-5)

- 1 Tank indicator
- 2 Tank cover
- 3 2 x 230 V~ socket-outlets
- 4 Earth connection
- 5 Overload cut-out
- 6 Voltmeter
- 7 Oil filler screw
- 8 Oil drainage screw
- 9 Oil shortage cut-out
- 10 On/Off switch
- 11 Choke lever
- 12 Reversing starter
- 13 Petrol cock
- 14 Wheels
- 15 Axle

- 16 Foot
- 17 Push bar holder
- 18 Push bar
- 19 Screws size M8 x 40
- 20 Screws size M8 x 16
- 21 Washers for wheels
- 22 Securing split pins for wheels
- 23 Nuts M8
- 24 Screwdriver
- 25 Spark plug wrench
- 26 Oil filler funnel

4. Intended use

The device is designed for applications operated with a 230 V alternating current source.

Be sure to observe the restrictions in the safety instructions. The generator is intended to provide electric power tools and light sources with electricity. When using the device with household appliances, please check their suitability in accordance with the relevant manufacturer's instructions. In case of doubt, ask an authorized dealer of the respective equipment.

The equipment is to be used only for its prescribed purpose. Any other use is deemed to be a case of misuse. The user/operator and not the manufacturer will be liable for any damage or injuries of any kind caused as a result of this.

Please note that our equipment has not been designed for use in commercial, trade or industrial applications. Our warranty will be voided if the equipment is used in commercial, trade or industrial businesses or for equivalent purposes.

GB/IE/
CY

5. Technical data

Generator:	Synchronous
Protection type:	IP23
Continuous rated power P_{rated} (S1):	2600 W
Maximum power P_{max} (S2 2 min):	2800 W
Rated voltage U_{rated} :	2 x 230V~
Rated current I_{rated} :	11.3 A
Frequency F_{rated} :	50 Hz
Drive engine design:	4-stroke, air-cooled
Displacement:	208 cm ³
Max. power:	5.1 kW / 7 bhp
Fuel:	Petrol
Tank capacity:	15 l
Engine oil:	approx. 0.6 l (15W40)
Consumption at 2/3 load:	approx. 1.36 l/h
Weight:	43 kg
L_{pA} sound pressure level:	76 dB(A)
L_{WA} sound power level	96 dB(A)
K uncertainty:	1.4 dB(A)
Power factor $\cos \varphi$:	1
Power class:	G1
Max. temperature:	40°C
Max. altitude (above mean sea level):	1,000 m
Spark plug:	F7 RTC

Operating mode S1 (continuous operation)

The equipment can be continuously operated with the quoted power output.

Operating mode S2 (temporary operation)

The equipment may be temporarily operated with the quoted power output (2 min). Afterwards the equipment must be stopped for a while to prevent it from overheating (2 min).

6. Before starting the equipment

6.1 Assembly

The installation of the equipment requires two open-ended wrenches (size 12).

- Assemble the foot (16), wheels (14) and push bar (18) as shown in Figures 6-9.
- Assemble all parts before filling in fuel and oil in order to prevent the fluids from leaking out.
- To mount the wheels, first slide the axle (15) through the mountings on the bottom of the generator and fit the wheels (14) as shown on Figure 7.
- When fitting the push bar (18) check that the angled side (Fig. 9/Item E) is pointing outwards to ensure that the swing up function works properly.

6.2 Electrical safety

- Electric supply cables and connected equipment must be in perfect condition.
- The generator is to be operated only with equipment whose voltage specifications conform to the generator's output voltage.
- Never connect the generator to the power supply (socket-outlet).
- Keep the cable length to the consumer as short as possible.

6.3 Environmental protection

- Dispose of soiled maintenance material and operating materials at the appropriate collection point.
- Recycle packaging material, metal and plastics.

6.4 Connecting to earth

The housing must be connected to earth in order to discharge static electricity. To do this, connect one end of a cable to the earth connection on the generator (Fig. 3/Item 4) and the other end to an external earth (for example an earthing rod).

7. Operation

Important. You must fill up with engine oil (approx. 0.6 l) and fuel before you can start the engine.

- Check the fuel and engine oil levels and top up if necessary.
- Make sure that the generator has sufficient ventilation
- Make sure that the ignition cable is secured to the spark plug.
- Inspect the immediate vicinity of the generator.
- Disconnect any electrical equipment which may already be connected to the generator.

7.1 Starting the engine

Important.

When starting with the reserve starter (12), the motor may recoil suddenly as it starts up, resulting in hand injuries. Wear protective gloves when starting the equipment.

- Open the petrol cock (13) by turning it down
- Set the ON/OFF switch (10) to the "ON" position
- Move the choke lever (11) to position I Ø I.
- Start the engine with the reversing starter (12), by pulling forcefully on the handle. If the engine does not start, pull the handle again.
- Push the choke lever (11) back after the engine has started.

7.2 Connecting consumers to the generator

- Connect the equipment you want to use to the 230 V~sockets (3).

Important: These sockets may be loaded continuously (S1) with 2600W and temporarily (S2) for a maximum of 2 minutes with 2800W.

- The generator is suitable for 230 V~ AC appliances only.
- Do not connect the generator to the household mains system as this may result in damage to the generator itself or to other electrical appliances in your home.

Note: Some electrical appliances (power jigsaws, drills, etc.) may have a higher level of power consumption when used in difficult conditions

7.3 Switching off the engine

- Before you switch off the generator, allow it to run briefly with no consumers so that it can "cool down".
- Set the ON/OFF switch (10) to the "OFF" position.
- Close the petrol cock (13).

7.4 Overload cut-out 2 x 230 V socket-outlets

Important. The generator is fitted with an overload cut-out.

This shuts down the sockets (3). You can restart the sockets (3) by pressing the overload cut-out (5).

Important. If this happens, reduce the electric power you are taking from the generator or remove any defective connected appliances.

Important. Defective overload cut-outs must be replaced only by overload cut-outs of identical design and with the same performance data. If repairs are necessary, please contact your customer service center.

GB/IE/
CY

8. Cleaning, maintenance, storage, transport and ordering of spare parts

Switch off the motor and pull the spark plug boot from the spark plug before doing any cleaning and maintenance work on the equipment.

Important: Switch off the equipment immediately and contact your service station:

- In the event of unusual vibrations or noise
- If the engine appears to be overloaded or misfires

8.1 Cleaning

- Keep all safety devices, air vents (Fig. 2/Item L) and the motor housing free of dirt and dust as far as possible. Wipe the equipment with a clean cloth or blow it down with compressed air at low pressure.
- We recommend that you clean the equipment immediately after you use it.
- Clean the equipment regularly with a damp cloth and some soft soap. Do not use cleaning agents or solvents; these may be aggressive to the plastic parts in the equipment. Ensure that no water can get into the interior of the equipment.

8.2 Air filter

In this connection, please also read the service information.

- Clean the air filter at regular intervals, and replace it if necessary.
- Open both clips (Fig. 11/A) and remove the air filter cover (Fig. 11/B).
- Remove the filter elements (Fig. 12/C)
- Do not use abrasive cleaning agents or petrol to clean the elements.
- Clean the elements by tapping them on a flat surface. In cases of stubborn dirt first clean with soapy water, then rinse with clear water and air-dry.
- Assemble in reverse order.

8.3 Spark plug (Fig. 13-14)

Check the spark plug for dirt and grime after 20 hours of operation and if necessary clean it with a copper wire brush. Thereafter service the spark plug after every 50 hours of operation.

- Pull off the spark plug boot (Fig. 13) by twisting.
- Remove the spark plug (Fig. 14/D) with the supplied spark plug wrench (25).
- Assemble in reverse order.

8.4 Changing the oil and checking the oil level (before using the equipment)

The motor oil is best changed when the motor is at working temperature.

- Only use motor oil (15W40).
- Place the generator on a slightly inclined surface so that the oil drainage screw (8) is at the lower end.
- Open the oil filler screw (7).
- Open the oil drainage screw and let the hot engine oil drain out into a drip tray.
- After the old oil has drained out, close the oil drainage screw and place the generator on a level surface again
- Fill in engine oil up to the top mark on the oil dip stick (approx. 0.6 liters).
- Important: Do not screw the dipstick (oil filler screw) in to check the oil level, simply insert it up to the thread.
- Dispose of the waste oil properly.

8.5 Automatic oil cut-out

The automatic oil cut-out responds if there is too little oil in the engine. In this case it will not be possible to start the engine or it will cut out automatically after a short period of time. It cannot be started again until the engine oil has been topped up (see point 8.4).

8.6 Preparing the equipment for long-term storage

Warning: Do not empty the petrol tank in enclosed areas, near fire or when smoking. Petrol fumes can cause explosions and fire.

- Empty the petrol tank using a petrol suction pump.
- Start the engine and run it until the tank and fuel line are completely empty and the engine stalls.
- Change the oil after each season. To do so, remove the used engine oil when the engine is warm and refill new oil.
- Remove the spark plug (Fig. 14/Item D). Use an oil can to fill the cylinder with approx. 20 ml of oil. Slowly pull back the starter cord, which will bathe the cylinder wall with oil. Screw the spark plug back in.
- Be sure to clean the entire equipment to protect the paint.
- Store the equipment in a well-ventilated place or location.

8.7 Preparing the equipment for transport

- Empty the petrol tank using a petrol suction pump.
- Always let the engine run until it has used up the remainder of petrol in the tank.
- Empty the engine oil from the warm engine.
- Remove the spark plug boot (Fig. 13) from the spark plug.
- Secure the equipment, e.g. with straps, against shifting.

8.8 Ordering replacement parts

Please provide the following information on all orders for spare parts:

- Model/type of the equipment
- Article number of the equipment
- ID number of the equipment

For our latest prices and information please go to www.isc-gmbh.info

9. Disposal and recycling

The equipment is supplied in packaging to prevent it from being damaged in transit. The raw materials in this packaging can be reused or recycled. The equipment and its accessories are made of various types of material, such as metal and plastic. Defective components must be disposed of as special waste. Ask your dealer or your local council.



For EU countries only

Never place any electric power tools in your household refuse.

To comply with European Directive 2002/96/EC concerning old electric and electronic equipment and its implementation in national laws, old electric power tools have to be separated from other waste and disposed of in an environment-friendly fashion, e.g. by taking to a recycling depot.

Recycling alternative to the return request: Instead of returning the equipment to the manufacturer, the owner of the electrical equipment is obliged to ensure that the equipment is properly disposed of if he abandons ownership. The old equipment can be returned to a suitable collection point, that will dispose of the equipment in accordance with the national recycling and waste disposal regulations. This does not apply to any accessories or aids without electrical components supplied with the old equipment.

GB/IE/
CY

10. Troubleshooting guide

Fault	Cause	Remedy
Engine does not start	Automatic oil cut-out has not responded	Check oil level, top up engine oil
	Spark plug fouled	Clean or replace spark plug (electrode spacing 0.6 mm)
	No fuel	Refuel / have the petrol cock checked
Generator has too little or no voltage	Controller or capacitor defective	Contact your dealer
	Overcurrent circuit-breaker has triggered	Actuate the circuit-breaker and reduce the consumers
	Air filter dirty	Clean or replace the filter

11. Maintenance schedule

Please adhere to the following maintenance periods in order to ensure a failure-free operation.

Important. The equipment must be filled with engine oil and fuel before it is started.

	Before each use	After an operating period of 20 hours	After an operating period of 50 hours	After an operating period of 100 hours	After an operating period of 300 hours
Checking the engine oil	X				
Changing the engine oil		For the first time, then every 50 hours	X		
Checking the air filter	X				Change the filter insert if necessary
Cleaning the air filter			X		
Cleaning the petrol filter				X	
Visual inspection of the equipment	X				
Cleaning the spark plug			Distance: 0.6 mm, replace if necessary		
Checking and readjusting the throttle valve on the carburetor					X*
Cleaning the cylinder head					X*
Set the valve play					X*

Important: The positions marked with "x*" should only be carried out by an authorized dealer.

GB/IE/
CY

12. Declaration of conformity

Einhell Germany AG · Wiesenweg 22 · D-94405 Landau/Isar

**Konformitätserklärung**

- erklart folgende Konformitat gema EU-Richtlinie und Normen fur Artikel
 explains the following conformity according to EU directives and norms for the following product
 dclare la conformit suivante selon la directive CE et les normes concernant l'article
 dichiara la seguente conformit secondo la direttiva UE e le norme per l'articolo
 verklaart de volgende overeenstemming conform EU richtlijn en normen voor het product
 declara la siguiente conformidad a tenor de la directiva y normas de la UE para el artculo
 declara a seguinte conformidade, de acordo com a directiva CE e normas para o artigo
 attesterer flgende verensstmmelse i medfr af EU-direktiv samt standarder for artiklen
 frklarar fljande verensstmmelse enl. EU-direktiv och standarder fr artikeln
 vakuuttaa, ett tuote tytta EU-direktiivin ja standardien vaatimukset
 tendab toote vastavust EL direktiivile ja standarditele
 vydav nsledujc prohlsen o shod podle smrnice EU a norem pro vrobek
 potrjuje sledeo skladnost s smernico EU in standardi za izdelek
 vydava nasledujce prehlsenie o zhode podl'a smernice E a noriem pre vrobok
 a cikkekhez az EU-irnyvonal s Normk szerint a kvetkezto konformitst jelenti ki
 deklaruje zgodnosc wymienionego ponizej artykuu z nastpujcymi normami na podstawie dyrektywy WE.
 декларира съответното съответствие съгласно Директива на ЕС и норми за артикул
 paskaidro šadu atbilstību ES direktīvai un standartiem
 apibūdzina šj atitikmā EU reikalavimams ir preks normoms
 declar urmtoarea conformitate conform directivei UE și normelor pentru articolul
 δηλνει την ακλουθη συμμρφωση σύμφωνα με την Οδηγία ΕΚ και τα πρτυπα για το προϊόν
 potrduje sljedeu uskladenost prema smjernicama EU i normama za artikl
 potrduje sljedeu uskladenost prema smjernicama EU i normama za artikl
 potrduje sledeu uskladenost prema smernicama E i normama za artikla
 следующим удостоверяется, что следующие продукты соответствуют директивам и нормам ЕС
 проголошує про зазначену нижче вдповднсть виробу директивам та стандартам ЄС на вирб
 ja izjavuva slednata soobrznost soglasno E-direktivata i normite za artikli
 rn ile ilgili AB direktifleri ve normlari gereince aaıda aıklanan uygunluu belirtir
 erklrer flgende samsvar i henhold til EU-direktivet og standarder for artikkel
 Lsir uppfyllingu EU-reglna og annarra stala vru

Stromerzeuger P-SE 2800 (Parkside)

- | | |
|---|---|
| <input checked="" type="checkbox"/> 2006/95/EC | <input type="checkbox"/> 2006/42/EC |
| <input type="checkbox"/> 2006/28/EC | <input type="checkbox"/> Annex IV
Notified Body:
Notified Body No.:
Reg. No.: |
| <input type="checkbox"/> 2005/32/EC | |
| <input checked="" type="checkbox"/> 2004/108/EC | <input checked="" type="checkbox"/> 2000/14/EC_2005/88/EC |
| <input type="checkbox"/> 2004/22/EC | <input type="checkbox"/> Annex V |
| <input type="checkbox"/> 1999/5/EC | <input checked="" type="checkbox"/> Annex VI
Noise: measured L _{WA} = 94,6 dB (A); guaranteed L _{WA} = 96 dB (A)
P = 5,1 KW
Notified Body: TÜV SÜD Product Service GmbH (0036) |
| <input type="checkbox"/> 97/23/EC | |
| <input type="checkbox"/> 90/396/EC | <input checked="" type="checkbox"/> 2004/26/EC
Emission No.: e11*97/68SA*2004/26*1177*00 |
| <input type="checkbox"/> 89/686/EC_96/58/EC | |
| <input type="checkbox"/> 87/404/EC | |

Standard references: EN 12601; EN 55012; EN 61000-6-1

Landau/Isar, den 03.12.2009

Weichselgartner/General Manager

Guihua/Product Management

First CE: 09

Art.-No.: 41.524.14 I.-No.: 01019

Subject to change without notice

Archive-File/Record: 4152410-06-4155050-09

Documents registrar: Robert Mayn
Wiesenweg 22, D-94405 Landau/Isar

13. GUARANTEE CERTIFICATE

Dear Customer,

All of our products undergo strict quality checks to ensure that they reach you in perfect condition. In the unlikely event that your device develops a fault, please contact our service department at the address shown on this guarantee card. Of course, if you would prefer to call us then we are also happy to offer our assistance under the service number printed below. Please note the following terms under which guarantee claims can be made:

1. These guarantee terms cover additional guarantee rights and do not affect your statutory warranty rights. We do not charge you for this guarantee.
2. Our guarantee only covers problems caused by material or manufacturing defects, and it is restricted to the rectification of these defects or replacement of the device. Please note that our devices have not been designed for use in commercial, trade or industrial applications. Consequently, the guarantee is invalidated if the equipment is used in commercial, trade or industrial applications or for other equivalent activities. The following are also excluded from our guarantee: compensation for transport damage, damage caused by failure to comply with the installation/assembly instructions or damage caused by unprofessional installation, failure to comply with the operating instructions (e.g. connection to the wrong mains voltage or current type), misuse or inappropriate use (such as overloading of the device or use of non-approved tools or accessories), failure to comply with the maintenance and safety regulations, ingress of foreign bodies into the device (e.g. sand, stones or dust), effects of force or external influences (e.g. damage caused by the device being dropped) and normal wear resulting from proper operation of the device. This applies in particular to rechargeable batteries for which we nevertheless issue a guarantee period of 12 months.

The guarantee is rendered null and void if any attempt is made to tamper with the device.

3. The guarantee is valid for a period of 3 years starting from the purchase date of the device. Guarantee claims should be submitted before the end of the guarantee period within two weeks of the defect being noticed. No guarantee claims will be accepted after the end of the guarantee period. The original guarantee period remains applicable to the device even if repairs are carried out or parts are replaced. In such cases, the work performed or parts fitted will not result in an extension of the guarantee period, and no new guarantee will become active for the work performed or parts fitted. This also applies when an on-site service is used.
4. In order to assert your guarantee claim, please send your defective device postage-free to the address shown below. Please enclose either the original or a copy of your sales receipt or another dated proof of purchase. Please keep your sales receipt in a safe place, as it is your proof of purchase. It would help us if you could describe the nature of the problem in as much detail as possible. If the defect is covered by our guarantee then your device will either be repaired immediately and returned to you, or we will send you a new device.

Of course, we are also happy offer a chargeable repair service for any defects which are not covered by the scope of this guarantee or for units which are no longer covered. To take advantage of this service, please send the device to our service address.

Einhell UK Ltd
Morpeth Wharf · Twelve Quays
Birkenhead, Wirral
CH41 1LF
Tel. 0151 6491500 · Fax 0151 6491501

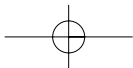
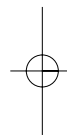
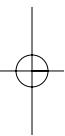

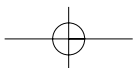
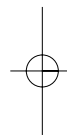
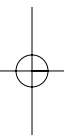



IAN: 45842

Einhell Germany AG

Wiesenweg 22

D-94405 Landau/Isar

Last Information Update: 12/2009

Ident.-No.: 41.524.14 122009 - 6

