



Grass Trimmer

User's Guide



After Sales Support

Now you have purchased a Gardenline product you can rest assured in the knowledge that as well as your 3 year parts and labour warranty you have the added peace of mind of dedicated helplines.

AFTER SALES SUPPORT

UK / N.IRELAND HELPLINE NO 0151 649 1500

REP. IRELAND HELPLINE NO 1890 946 244

MODEL NUMBER: 7446

Contents

- 08 Safety regulations
- 10 Items supplied
- 10 Layout
- 10 Explanation of the pictograms
- 10 Technical data
- 10 Assembly
- 10 Intended use
- 10 Before starting the equipment
- 11 Starting up
- 11 Using the grass trimmer as an edge trimmer
- 11 Replacing the line spool
- 11 Care and maintenance
- 11 Faults
- 12 Ordering spare parts



**Read the complete operating manual with due care and keep it in a safe place.
If you give the machine to any other person, hand over this operating manual as well!**

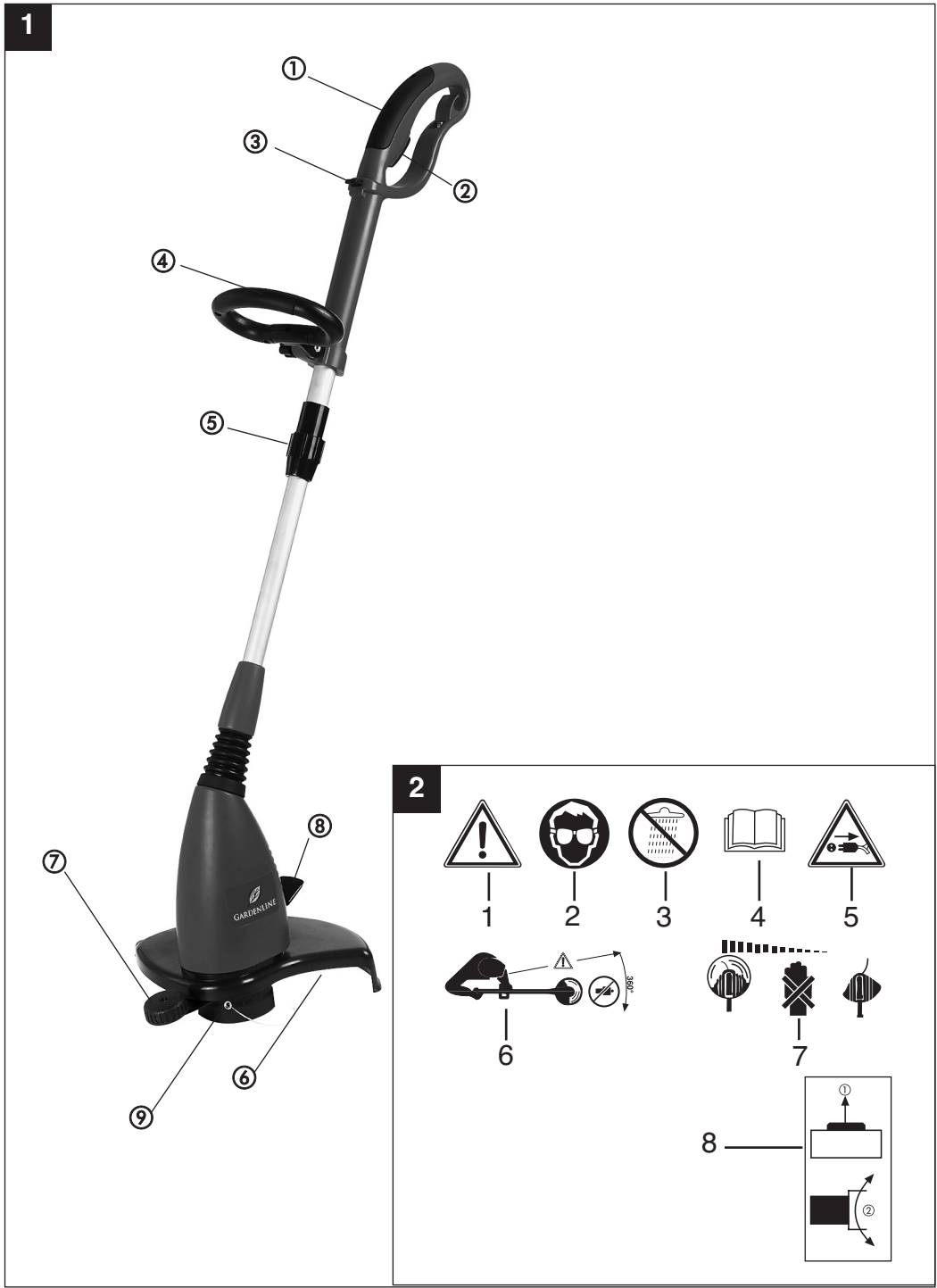

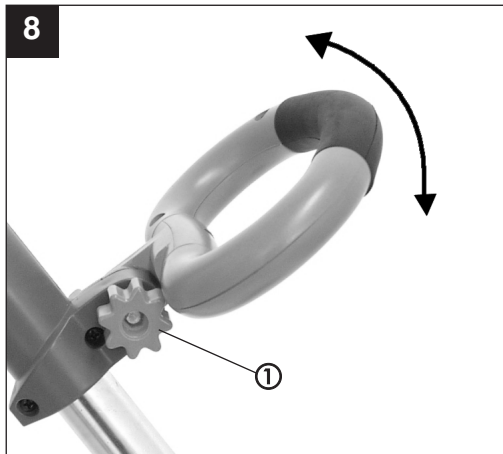
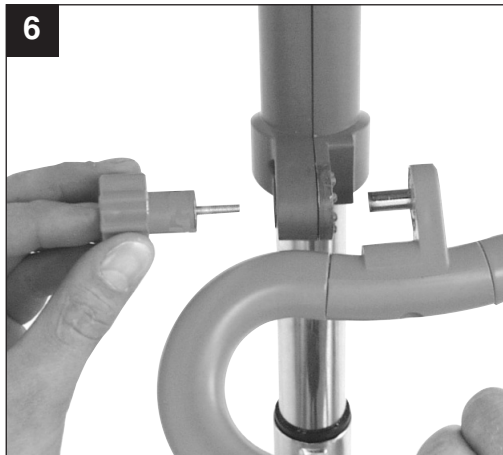

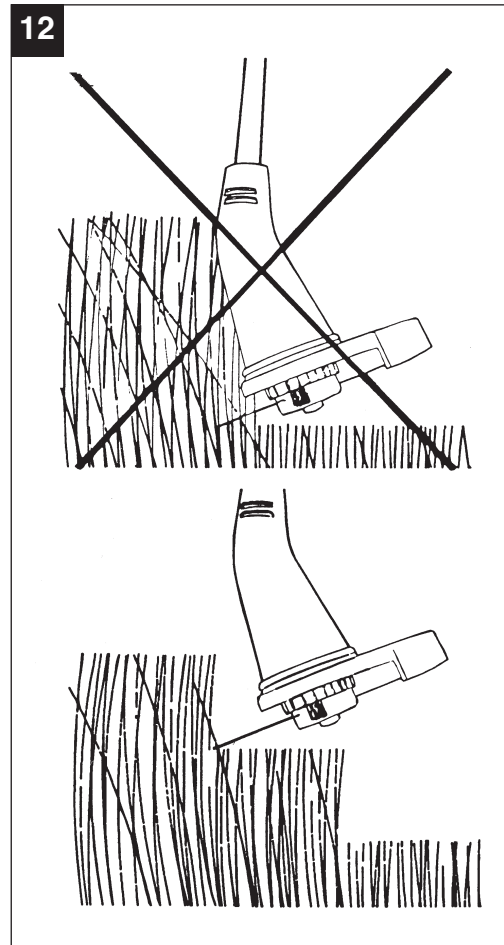
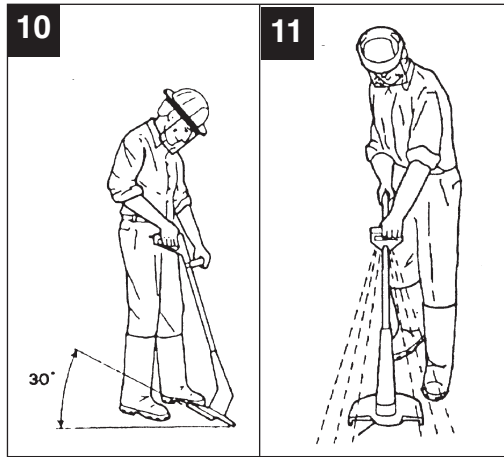

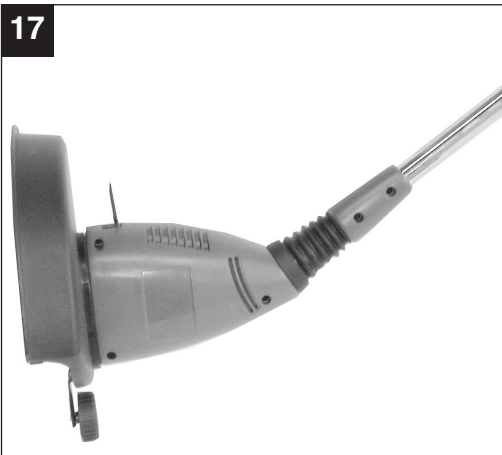
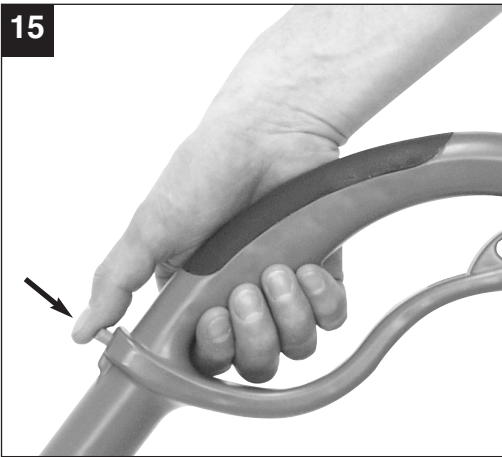

21



Congratulations on choosing to buy a Gardenline® product. By doing so you now have the assurance and peace of mind that comes with purchasing a product made by one of Europe's leading manufacturers.

All products brought to you by Gardenline® are manufactured to the highest standards of performance and safety, and, as part of our philosophy of customer service and satisfaction, are backed by our comprehensive 3 Year Warranty. Please fill in and return the Warranty Card to the address provided.

We hope you will enjoy using your purchase for many years to come.

Before you work with this grass trimmer, carefully read the following safety regulations and the operating instructions.

If you give the equipment to any other persons, give them the operating instructions as well.

Keep these instructions in a safe place.

Packaging:

Your equipment is packaged to protect it from damage in transit. Packaging is raw material and can therefore be reused or returned to the raw material system.

1. Safety regulations



Please read the operating instructions carefully and observe the information provided. It is important to consult these instructions in order to acquaint yourself with the equipment, its proper use and safety regulations.

Keep the instruction manual in a safe place for later use.

Important!

For safety reasons, the grass trimmer is not to be used by children, young people under 16 years of age, or any other persons who are not acquainted with these operating instructions.

- Always inspect the equipment visually before using it. Do not use the equipment if safety devices are damaged or worn. Never disable safety devices.
- Use the equipment only for the purposes indicated in these operating instructions.
- You are responsible for safety in the work area.
- Before you begin your work, examine the material you want to cut. Remove any foreign bodies. Continue to watch out for foreign bodies while you are working. If you come across any foreign bodies while cutting, turn off the machine and remove the items in question.
- Work only when visibility is adequate.
- Make sure you stand squarely at all times while working. Be careful when walking backwards. Tripping hazard!
- Never leave the equipment unsupervised in the work area. If you stop work for a while, leave the equipment in a safe place.
- If you stop your work in order to go to another area to work, you must make sure that the equipment is switched off while you are going there.
- Never use the equipment while it is raining or in damp or wet surroundings.
- Protect your equipment against moisture and rain.
- Before you switch on the equipment, check that the nylon line will not touch any stones or other objects.
- Always wear suitable working clothes to prevent injuries to the head, hands and feet. For this purpose wear a helmet, safety goggles (or visor), high boots (or strong shoes and long trousers made of tough fabric) and work gloves.
- When the equipment is in operation, you must always hold it away from your body!
- Do not switch on the equipment when it is turned around or when it is not in working position.
- Switch off the motor and pull out the power plug when the equipment is not being used, when you leave it unsupervised, when checking the equipment, if the power cable is damaged, when removing or replacing the spool, or when transporting the equipment from one place to another.
- Keep the equipment away from other people, especially children, and from pets. There may be stones and other objects in the grass that is cut and thrown up.
- When you are working, keep a distance of at least 5 m from other persons and pets.
- Do not cut against hard objects. This will help you to prevent causing injury to yourself and damage to the equipment.
- Use the edge of the safety guard to keep the equipment away from walls, different surfaces and fragile objects.
- Never use the equipment without the safety guard.

⚠ IMPORTANT! The safety guard is there to ensure your safety and the safety of others. It is also essential for the equipment to work correctly. Failure to comply with this instruction will invalidate your warranty as well as create a potential source of danger.

- Never use your hands to try to stop the cutting unit (nylon line). Always wait for it to stop by itself.
- Never use any nylon line other than the original nylon line. Under no circumstances should you use metal wire in place of the nylon line.
- Beware of injuring yourself on the device for cutting the line to length.
- Make sure that the air vents are free of dirt.
- Disconnect the equipment from the mains after use and check the equipment for damage.
- Do not try to use the equipment to cut grass which is not growing on the ground; for example, do not try to cut grass growing on walls or stones, etc.
- The person operating the grass trimmer is liable for any damages sustained by third parties within the equipment's working radius as a result of its use.
- Do not cross roads or gravel paths with the equipment switched on.
- When you are not using the equipment, keep it in a dry place out of the reach of children.
- Use the equipment only in the way described in these operating instructions and always hold it perpendicular to the ground. Every other position is dangerous.
- Check at regular intervals that the screws are properly tightened.
- The mains supply must be the same as the voltage indicated on the rating plate.
- Keep extension cables away from cutting tools at all times.
- The power cable must be examined regularly for signs of damage or ageing. Do not use the equipment if the power cable is in a less than perfect condition.
- The power cables used are not to be of a lighter duty class than light rubber-insulated HO7RN-F in accordance with DIN 57282/VDE 0282 and they must have a minimum diameter of 1.5 mm². Plug connections must have earthing contacts and the coupling must be protected from rainwater.
- If the cable is damaged during operation, disconnect it immediately from the power supply. **DO NOT TOUCH THE CABLE BEFORE IT IS**

DISCONNECTED FROM THE POWER SUPPLY.

- To prevent danger, damaged power cables must be replaced by the manufacturer or by a service company authorized to carry out the work by the manufacturer.
- The equipment may only be powered via an earth-leakage circuit breaker (RCD) with a maximum operating current of 30 mA.
- The area to be cut must always be kept cleared of cables and other objects.
- If the equipment has to be lifted for transporting, be sure to switch off the motor first and wait for the cutter to come to a standstill. Each time before you leave the equipment, switch off the motor and pull out the power plug.
- Before you connect the equipment to the power supply, make sure that none of the rotating components is damaged and that the line reel is properly inserted and secured.
- Under no circumstances are you to cut against hard objects during use. This is imperative to prevent injury to yourself and damage to the equipment.
- Use only original replacement parts for repairs.
- Repairs may only be carried out by a qualified electrician.
- Before starting up the equipment, and after any collision, check the equipment for signs of wear or damage and have any necessary repairs carried out.
- Always keep your hands and feet away from the cutting unit, especially when switching the motor on.
- After you pull out a new line, always turn the equipment to its normal working position before switching on.
- Never use spare parts and accessories which are not provided or recommended by the manufacturer.
- Pull out the mains plug before checking, cleaning or doing any work on the equipment and when it is not being used.
- Use the equipment only in broad daylight or in well-lit conditions.

⚠ Important: The nylon line continues to rotate for a few seconds after the motor is switched off.

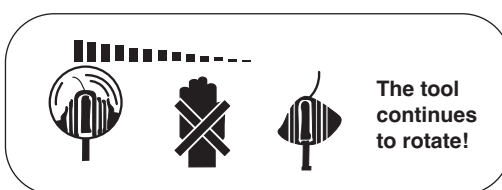

2. Items supplied (see Fig. 1)

- 1 Grass trimmer
- 1 Additional handle (4)
- 1 Safety guard (6)
- 1 Edge guide (7)
- 2 Thread spools (9)

3. Layout (see Fig. 1)

1. Upper Handle
2. ON/OFF switch
3. Selector button to turn the handle
4. Additional handle
5. Height adjustment
6. Safety guard
7. Edge guide
8. Pedal for angle adjustment
9. Line spool

4. Explanation of the pictograms (see Fig. 2)

- Item 1:** Warning!
- Item 2:** Wear eye protection!
- Item 3:** Protect from moisture!
- Item 4:** Read the instruction manual before starting!
- Item 5:** Pull out the mains plug before checking a damaged power cable!
- Item 6:** Keep other people out of the danger area!
- Item 7:** The tool continues to rotate!
- Item 8:** Using the grass trimmer as an edge trimmer

5. Technical data

Mains voltage:	230 V ~ 50 Hz
Performance	450 W
Cutting circle	Ø 29 cm
Revolutions n_0	9,500 min ⁻¹
Cutting line	Ø 1.4 mm
Sound pressure level L_{pA}	86.1 dB
Sound power level, L_{WA}	96 dB
Vibration a_{hv}	3.7 m/s ²
Weight	3 kg

Sound and vibration were measured in accordance with EN 786.

6. Assembly

- Mount the safety guard on the motor head (see Fig. 3) and secure with the supplied 4.2 x 13 mm screws (see Fig. 4).
- Then mount the edge guide with the supplied 4.2 x 10 mm screws (see Fig. 5).
- The handle is assembled as shown in Figure 6.

7. Intended use

The equipment is designed for cutting lawns and small areas of grass in private and hobby gardens. Equipment designed for use in private and hobby gardens is regarded as unsuitable for use in public facilities, parks and sports centers, along roadways, or in agriculture and forestry.

The operating instructions as supplied by the manufacturer must be kept and referred to in order to ensure that the machine is properly used and maintained.

Important! This equipment must not be used for composting purposes (shredding) as this could result in injury or damage to property.

8. Before starting the equipment

You can set your optimal working position by adjustments to the height and to the additional handle.

Height adjustment:

Place the grass trimmer on a firm surface. First slacken the union nut by turning it in the direction of the arrow (see Fig. 7). Then set the required length and retighten the union nut.

Adjusting the additional handle:

Place the grass trimmer on a firm surface. Slacken the screw (Fig. 8/Item 1) and move the additional handle to its optimal position. Lock the handle in place by tightening the screw.

Adjusting the tilt of the long handle

Place the grass trimmer on a firm surface. Press the pedal at the side of the motor housing with your foot (Fig. 21). Now you can set the long handle to the required tilt (Fig. 21). To fix the selected angle of tilt, release the pedal and let the long handle snap into place.

9. Starting up

The grass trimmer is designed only to cut grass. The grass trimmer has a fully automatic line extension system. If the line of the grass trimmer is shortened during operation to a diameter of approx. 230 mm, it will be automatically extended to the maximum cutting width (approx. 290 mm). This ensures that you can cut your lawn with the perfect cutting width at all times.

Note:

If the line is too long when you use the equipment for the first time, the surplus end of it will be cut by the blade on the safety cover.

To obtain maximum performance from your grass trimmer, please follow the instructions given below:

- Never use the grass trimmer without the guard.
- Do not mow grass when it is wet. The best results are achieved with dry grass.
- Connect the power cable to the extension cable and attach it in the handle (Fig. 9).
- To switch on your grass trimmer, press the ON/OFF switch (Fig. 1/Item 2).
- To switch off your grass trimmer, let go of the ON/OFF switch (Fig. 1/Item 2).
- Do not allow the grass trimmer near the grass until the switch is pressed, i.e. the grass trimmer is in operation.
- To cut properly, swing the machine sideways while moving forwards. Keep the grass trimmer inclined at an angle of approx. 30° while you do so (see Figs. 10 and 11).
- If the grass is long, the grass must be cut shorter in stages, starting from the tip (see Fig. 12).
- Use the edge guide and the guard hood to prevent unnecessary wear on the line (see Figs. 13 and 14).
- To avoid unnecessary wear on the line, keep the grass trimmer away from hard objects.

10. Using the grass trimmer as an edge trimmer

To cut the edges of lawns and flower beds, the grass trimmer can be converted as follows:

- Switch off the power supply of the grass trimmer.
- Press the selector button (Figure 15)
- Keep the button pressed and rotate the handle through 180° (Figure 16) until it latches in place.
- Now you have converted the grass trimmer to an edge trimmer for cutting the lawn vertically (Fig. 17).

11. Replacing the line spool

Important! Make sure that you pull out the power plug before replacing the line spool!

- Press the sides of the spool cover as shown and remove the cover (Figure 18 und Figure 19).
- Remove the empty line spool.
- Thread the ends of the line on the new line spool through the eyelets in the spool receptacle (Fig. 20).
- Fit the spool cover again.
- When you start the equipment again the line will be cut to the perfect length automatically.

Important!

Bits of the nylon line could cause injury when being flung out.

12. Care and maintenance

- Before putting away or cleaning the grass trimmer, switch off and pull out the power plug.
- Use a brush to remove deposits from the safety guard.
- Clean the plastic body and other plastic parts with a mild household cleaning agent and a damp cloth.
- Do not use any aggressive agents or solvents for cleaning purposes.
- Never clean the grass trimmer by spraying with water. Prevent water getting inside the equipment at all costs.

13. Faults

The equipment does not work: Check that the power cable is connected properly and check the mains fuses. If the equipment will not work in spite of the voltage supply being OK, please send it to the specified after-sales service address.

14. Ordering spare parts

Please provide the following information on all orders for spare parts:

- Model/type of the equipment
- Article number of the equipment
- ID number of the equipment
- Part number of the required spare part

For our latest prices and information please go to www.isc-gmbh.info

WARRANTY CERTIFICATE

The product described in these instructions comes with a 3 year manufactures warranty covering defects. This 3-year manufactures warranty period begins with the passing of risk or when the customer receives the product.

For warranty claims to be accepted, the product has to receive the correct maintenance and be put to the proper use as described in the operating instructions.

Your statutory rights of warranty are naturally unaffected during these 3 years.

This warranty applies in Germany, or in the respective country of the manufacturer's main regional sales partner, as a supplement to local regulations. Please note the details for contacting the customer service center responsible for your region or the service address listed below.

GB Einhell UK Ltd
Unit 5 Morpeth Wharf
Twelve Quays
Birkenhead, Wirral
CH 41 1LF

Helpline-No.: GB 0151 649 1500
IRL 189 094 6244

Technical changes subject to change

HELPLINE No. UK / N.IRELAND 0151 649 1500 REP. IRELAND HELPLINE NO 189 094 6244
Model Number: 7446

13

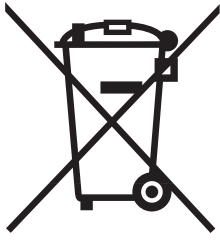

For EU countries only

Never place any electric tools in your household refuse.

To comply with European Directive 2002/96/EC concerning old electric and electronic equipment and its implementation in national laws, old electric tools have to be separated from other waste and disposed of in an environment-friendly fashion, e.g. by taking to a recycling depot.

Recycling alternative to the demand to return electrical devices:

As an alternative to returning the electrical device, the owner is obliged to cooperate in ensuring that the device is properly recycled if ownership is relinquished. This can also be done by handing over the used device to a returns center, which will dispose of it in accordance with national commercial and industrial waste management legislation. This does not apply to the accessories and auxiliary equipment without any electrical components which are included with the used device.

The reprinting or reproduction by any other means, in whole or in part, of documentation and papers accompanying products is permitted only with the express consent of ISC GmbH.

HELPLINE No. UK / N.IRELAND 0151 649 1500 REP. IRELAND HELPLINE NO 189 094 6244
Model Number: 7446



Konformitätserklärung

Hans Einhell AG · Wiesenweg 22 · D-94405 Landau/Isar

D erklärt folgende Konformität gemäß EU-Richtlinie und Normen für Artikel
GB declares conformity with the EU Directive and standards marked below for the article
F déclare la conformité suivante selon la directive CE et les normes concernant l'article
NL verklaart de volgende conformiteit in overeenstemming met de EU-richtlijn en normen voor het artikel
E declara la siguiente conformidad a tenor de la directiva y normas de la UE para el artículo
P declara a seguinte conformidade de acordo com a directiva CE e normas para o artigo
S förklarar följande överensstämmelse enl. EU-direktiv och standarder för artikeln
FIN ilmoittaa seuraavaa Euroopan unionin direktiivien ja normien mukaista yhdenmukaisuutta tuotteelle
N erklærer herved følgende samsvar med EU-direktiv og standarder for artikkel
BS заявляет о соответствии товара следующим директивам и нормам ЕС
HR izjavljuje sljedeću uskladenost s odredbama i normama EU za artikl.
RO declară următoarea conformitate cu linia directoare CE și normele valabile pentru articolul.
TR ürün ile ilgili olarak AB Yönetmelikleri ve Normları gereğince aşağıdaki uygunluk açıkla masını sunar.
GR δηλώνει την ακόλουθη συμφώνια σύμφωνα με την Οδηγία ΕΕ και τα πρότυπα για το προϊόν

I dichiara la seguente conformità secondo la direttiva UE e le norme per l'articolo
DK attesterer følgende overensstemmelse i henhold til EU-direktiv og standarder for produkt
CZ prohlašuje následující shodu podle směrnice EU a norem pro výrobek.
H a következő konformitást jelenti ki a termékerekre vonatkozó EU-irányvonalak és normák szerint
SV pojasnjuje sledečo skladnost po smernici EU in normah za artikel.
PL deklaruje zgodność wymienionego poniżej artykułu z następującymi normami na podstawie dyrektywy WE.
SK vydáva nasledujúce prehlásenie o zhode podľa smernice EÚ a noriem pre výrobok.
SR декларира следното съответствие съгласно директивите и нормите на ЕС за продукта.
UA заявляє про відповідність згідно з Директивою ЄС та стандартами, чинними для даного товару
ES deklareerib vastavuse järgnevalele EL direktiivi dele ja normidele
LT deklaruoja atitiktį pagal ES direktyvas ir normas straipsniui
RU izjavlja sledeći konformitet u skladu s odredbom EZ i normama za artikl
LV Atbilstības sertifikāts apliecina zemāk minēto preču atbilstību ES direktīvām un standartiem
IS Samræmisýfirlýsing staðfestir eftirfarandi samræmi samkvæmt reglum Evrópubandalagsins og stöðlum fyrir vörur

Grass Trimmer GLT 453

<input checked="" type="checkbox"/> 98/37/EG	<input type="checkbox"/> 87/404/EWG
<input checked="" type="checkbox"/> 2006/95/EG	<input type="checkbox"/> R&TTED 1999/5/EG
<input type="checkbox"/> 97/23/EG	<input checked="" type="checkbox"/> 2000/14/EG: $L_{WM} = 95,1 \text{ dB}$; $L_{WA} = 96 \text{ dB}$ $\varnothing = 29 \text{ cm}$
<input checked="" type="checkbox"/> 89/336/EWG_93/68/EEC	<input type="checkbox"/> 95/54/EG:
<input type="checkbox"/> 90/396/EWG	<input type="checkbox"/> 97/68/EG:
<input type="checkbox"/> 89/686/EWG	

EN 786; EN 60335-1; EN 60335-2-91; EN 55014-1;
 EN 55014-2; EN 61000-3-2; EN 61000-3-3
 TÜV Süddeutschland Bau und Betrieb; KBV VI; OR/10565/06

Landau/Isar, den 14.05.2007

 Weichselgartner
 General-Manager

 Gottelt
 Product-Management

Art.-Nr.: 34.015.57 I.-Nr.: 01017
 Subject to change without notice

Archivierung: 3401548-13-4155050

