



18V LITHIUM ION

210MM MITRE SAW

ORIGINAL INSTRUCTIONS

MAINTENANCE

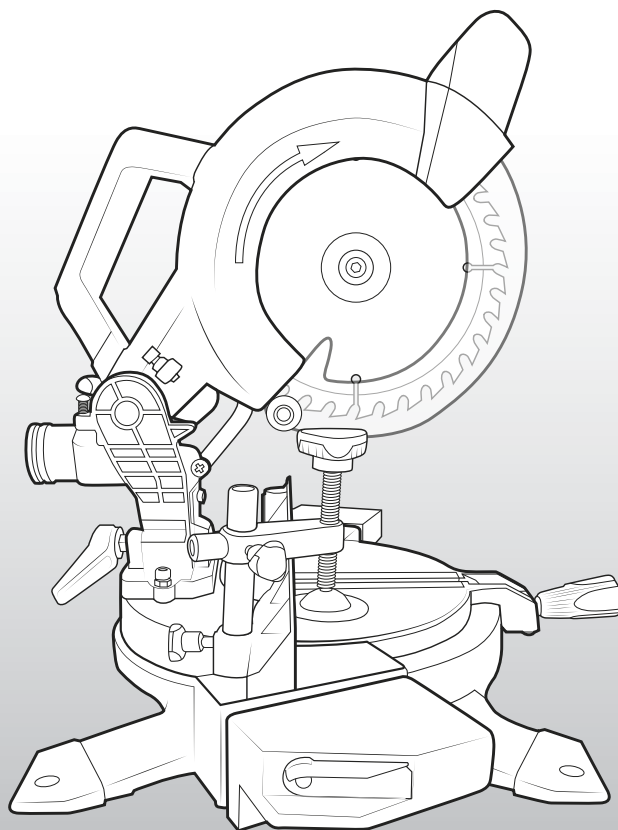

STANDARD EQUIPMENT

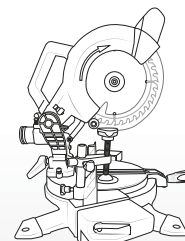

Compound Mitre Saw



Dust Bag

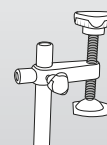

Material Clamp



Hex Key

5 YEAR
REPLACEMENT WARRANTY



PXCMSS-210U

Art.-No.: 30.003.44 I.-No.: 11018

TROUBLESHOOTING

LED lights do not illuminate on charger

Check the charging adaptor is securely plugged into the wall out let.
Check the battery is firmly connected to the charging cradle.
Check that the charging jack is securely connected to the charging cradle.

Sparking visible through the housing air vents

A small amount of sparking may be visible through the housing vents. This is normal and does not indicate a problem.

Worklight or laser line is not turning on

The worklight only turns on once a charged battery is fitted and the worklight or laser light switch is switch on.
Ensure the light source is not covered in dust. Use a dry cloth to wipe away dust.

Mitre Saw Tips

Allow the saw to reach full speed before beginning a cut.
Never force the saw. Use light and continuous pressure.
When cutting is interrupted, to resume cutting, start the saw and allow the blade to reach full speed, re-enter the cut slowly and resume cutting.
When cutting across the grain, the fibres of the wood have a tendency to tear and lift. Advancing the saw slowly minimizes this effect.

MAINTENANCE



WARNING! ALWAYS ENSURE THE TOOL HAS COMPLETELY STOPPED AND THE BATTERY IS REMOVED PRIOR TO ANY MAINTENANCE.

- Keep ventilation slots of the mitre saw clean at all times to ensure efficient operation.
- After each use, blow air through the tool housing to ensure it is free from all dust, dirt, etc. Build up of dust, dirt particles may cause the tool to overheat and shorten the life of the tool.
- Empty the dust bag regularly.
- If the housing of the saw requires cleaning, do not use solvents but a moist soft cloth or soft brush only.
- Never let any liquid get inside the tool, never immerse any part of the tool into liquid.
- No lubrication is necessary as the tool has sealed bearings.
- When not in use, the mitre saw should be stored in a dry, frost free location not within the reach of children.

Note: Ozito Industries will not be responsible for any damage or injuries caused by the repair of the circular saw by an unauthorised person or by mishandling of the circular saw.

ONLINE MANUAL

Scan this QR Code with your mobile device to take you to the online manual.



1. CHANGING THE BLADE

WARNING! ENSURE THE TOOL IS SWITCHED OFF AND DISCONNECTED FROM THE POWER SUPPLY BEFORE PERFORMING ANY OF THE FOLLOWING TASKS.

CAUTION! NEVER TRY TO USE A BLADE THAT IS LARGER THAN THE STATED CAPACITY OF THE MITRE SAW. IT MIGHT COME INTO CONTACT WITH THE BLADE GUARDS AND RISK PERSONAL INJURY OR DAMAGE TO THE MITRE SAW. THIS WILL NOT BE COVERED UNDER WARRANTY.

CAUTION! NEVER USE A BLADE THAT IS TOO THICK TO ALLOW THE OUTER FLANGE TO ENGAGE WITH THE FLATS ON THE SPINDLE. IT WILL PREVENT THE BLADE SCREW FROM PROPERLY SECURING THE BLADE ONTO THE SPINDLE.

CAUTION! ENSURE THAT THE CORRECT BLADE BUSH THAT MAY BE REQUIRED SUITS THE SPINDLE AND BLADES THAT ARE FITTED.

The tool is recommended for wood cutting only and is not recommended for use with abrasive wheels or masonry/diamond cutting wheels. Only use 210mm wood cutting blades.

- 1 Ensure the cutting head is raised. Press the spindle lock button in while rotating the blade clockwise using a hex key in the central blade bolt.

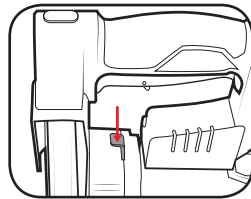

- 2 Once the spindle lock stops the blades rotation, rotate the blade bolt clockwise to remove the bolt and outer flange.

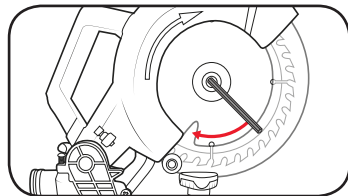

- 3 Raise the lower blade guard and remove the blade from the spindle.

Note: Make sure the inner flange stays in place on the spindle.

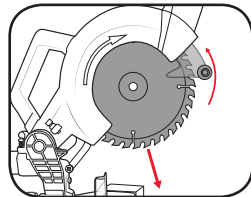

- 4 Install the new the blade over the spindle and onto the inner flange.

Note: Ensure the blade is fitted so that the arrow on the blade matches the same direction as the arrow on the guard.

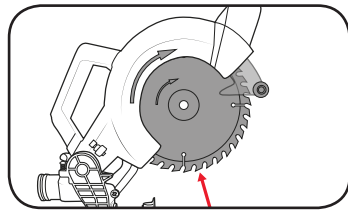

- 5 Fit the outer flange by placing the cupped side against the blade followed by the washer and blade bolt.

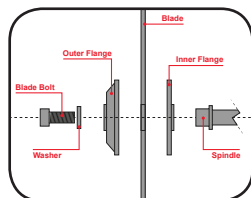

- 6 Depress the spindle lock and then tighten the blade bolt using a hex key in an anti-clockwise direction.

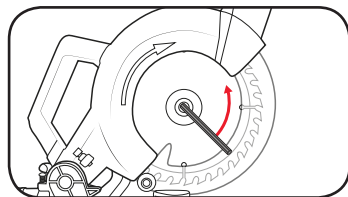

Make sure the lower guard operates smoothly and properly protects you from the blade before using the saw.

WARNING! TO ENSURE THE CORRECT BLADE ROTATION, ALWAYS INSTALL THE BLADE WITH THE BLADE TEETH POINTING DOWNWARDS. ENSURE THE ARROW DIRECTION ON THE BLADE CORRESPONDS WITH THE ARROW ON THE UPPER BLADE GUARD.

2. SAW ALIGNMENT

The mitre saw should be set-up fairly accurate out of the box, but if the saw becomes misaligned, you can follow the instructions below to adjust the tool.

Fence Alignment

- 1 Set the mitre angle to 0°, lock the cutting head down and remove the upper rear fence by loosening the fence locking knob all the way out.

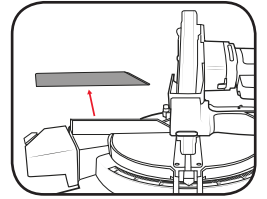

- 2 Loosen slightly all 4 hex bolts securing the rear fence in place.

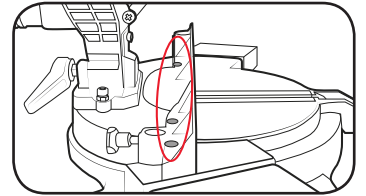

- 3 Lay a carpenters square on the table with one edge along the blade and the other along the fence. Any inaccuracy should be visible.

Note: The square must contact the blade, not the teeth, for an accurate reading.

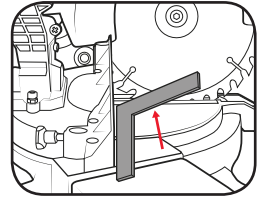

- 4 Gently tap the fence into position so that the fence is perfectly perpendicular to the blade. Retighten the bolts.

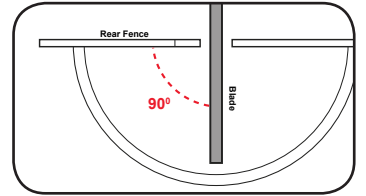

- 5 Make a test cut and repeat this process until the fence is adjusted accurately. Then you can reattach the upper rear fence.

Bevel Alignment

The saw has 2 bump stops that limit the bevel angle to 0° and 45°. If the bevel angle becomes inaccurate, these stops can be readjusted by following the steps below.

- 1 Set the bevel angle to 0°, lock the cutting head down and loosen the bevel locking lever.

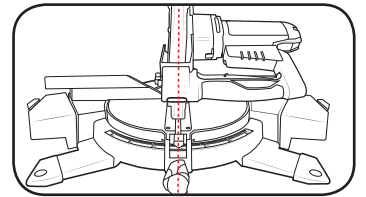

- 2 Lay a carpenters square along the table with one edge along the blade. Any inaccuracy should be visible.

Note: The square must contact the blade, not the teeth, for an accurate reading.

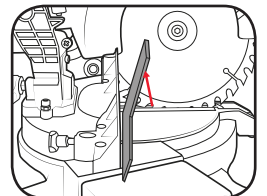

- 3 Loosen the right bump stop nut and adjust the screw until the blade is perpendicular with the table. Then tighten the nut to secure in position.

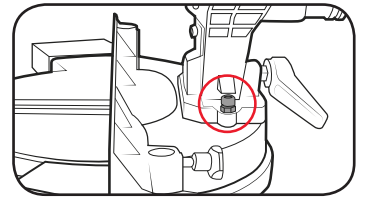

- 4 Repeat steps 2 and 3 for the left bump stop using a 45° angle carpenters triangle.

