

ozito

SANDER POLISHER

1100W

INSTRUCTION MANUAL

SPECIFICATIONS

Voltage:	230-240V ~ 50Hz
Power:	1100W
No Load Speed:	1,000 - 3,500/min
Disc Size:	180mm
Sander Base Fitment:	Hook & Loop
Weight:	2.2kg

ozito.com.au

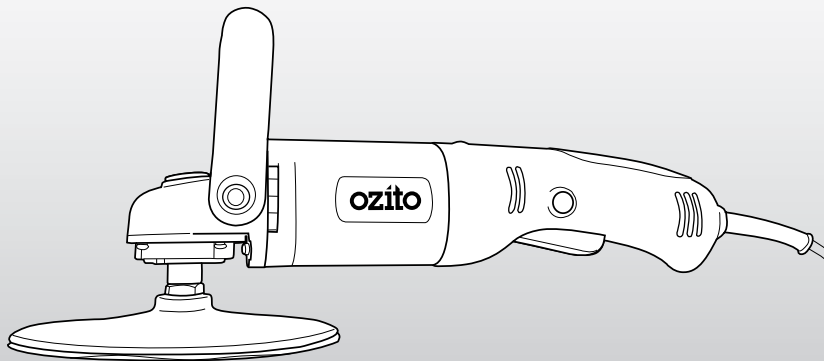

WHAT'S IN THE BOX

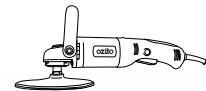

Sander Polisher

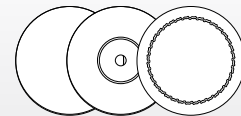

Assorted Discs

3 YEAR REPLACEMENT WARRANTY

SPR-7100

KNOW YOUR PRODUCT

Sander Polisher

- | | |
|---------------------------|--------------------------|
| 1 Spindle Lock Button | 5 Variable Speed Dial |
| 2 Hook & Loop Backing Pad | 6 On/Off Trigger |
| 3 Spindle | 7 Safety Lock-Off Button |
| 4 D-Shaped Front Handle | |

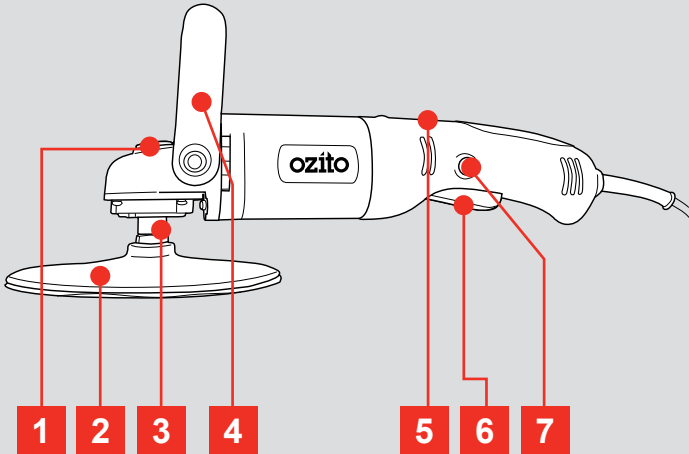

ACCESSORIES

- | | |
|--------------------------|--------------------------|
| 8 Sanding Paper x 6 | 11 Hex Key |
| 9 Sponge Pad | 12 Handle Locking Screws |
| 10 Wool Polishing Bonnet | |

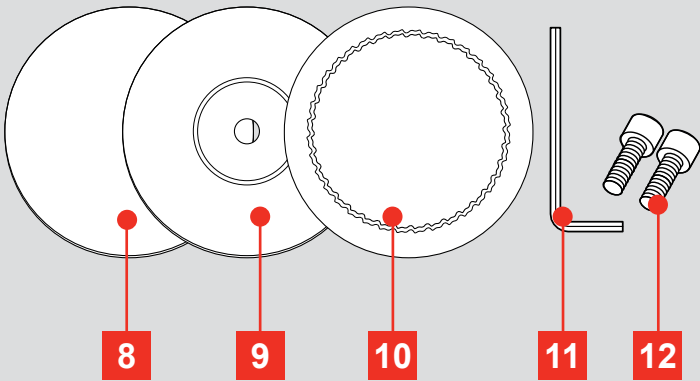

ONLINE MANUAL

Scan this QR Code with your mobile device to take you to the online manual.



SETUP & PREPARATION

1. ASSEMBLY



WARNING! ENSURE THE TOOL IS TURNED OFF AND DISCONNECTED FROM THE POWER SUPPLY BEFORE PERFORMING ANY OF THE FOLLOWING OPERATIONS.

Front Handle

- 1 Align the recess on the D-shaped handle to the ridge on the metal gear case.

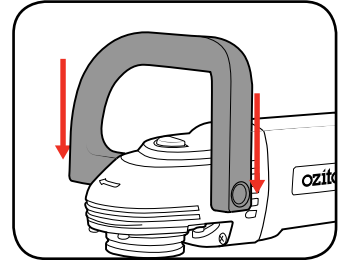

- 2 Slide the D-shaped handle on and insert the handle locking screws either side of the handle.

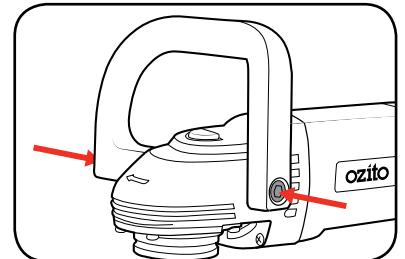

- 3 Tighten the screws using a hex key to secure the handle in place.

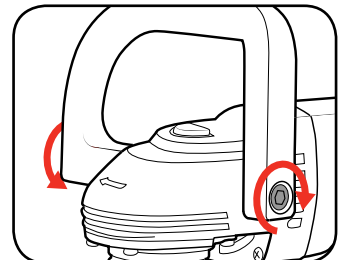

Attaching the Hook & Loop Backing Pad

- 1 Depress and hold the spindle lock.

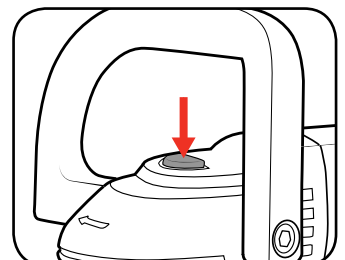

- 2 Screw the hook & loop backing pad onto the spindle tightly using a spanner.

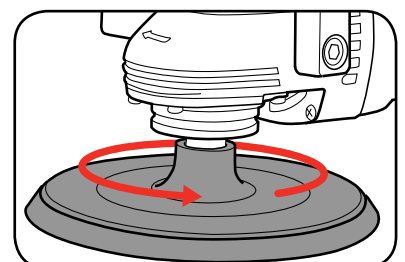

3 YEAR REPLACEMENT WARRANTY

2. ATTACHING ACCESSORIES

Sanding Paper

The sanding paper is great for sanding large, flat timber surfaces.

- 1 Ensure the hook & loop backing pad is secured onto the spindle.

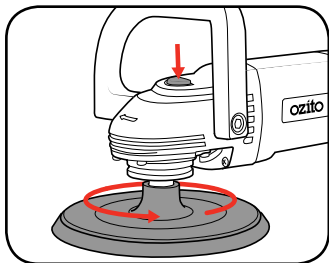

- 2 Align the sanding paper with the backing pad and then press firmly onto pad to attach.

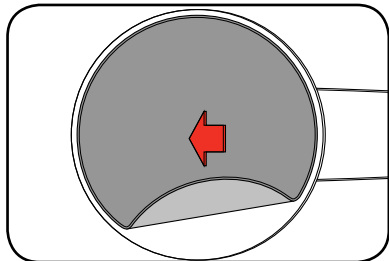

- 3 To remove, starting from an edge, pull the sanding paper away from the hook & loop backing pad.

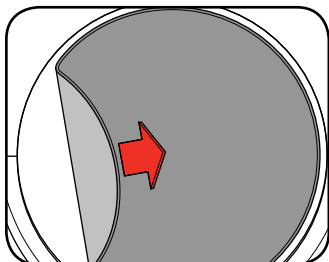

Sponge Pad

Use the sponge pad when you need to apply a polishing compound to a metal surface.

- 1 Push the foam pad onto the hook & loop backing pad.

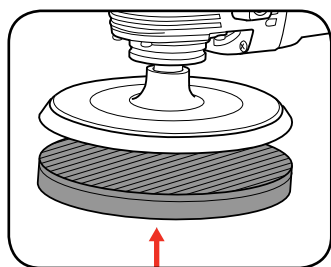

- 2 To remove the sponge pad, pull away from the backing pad.

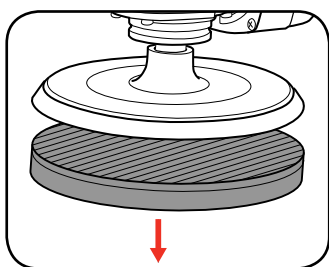

3. ATTACHING ACCESSORIES cont.

Polishing Bonnet

Use the polishing bonnet after the sponge pad to remove any polishing compound residue from the metal surface, producing a great polished finish.

- 1 Ensure the hook & loop backing pad is secured onto the spindle.

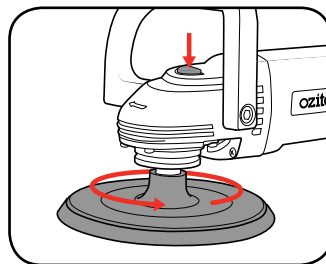

- 2 Stretch the sides of the polishing bonnet and pull over the backing pad.

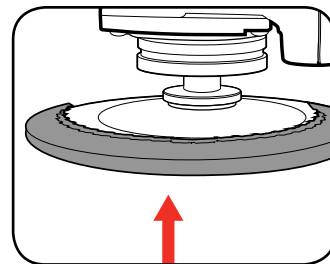

- 3 To remove the polishing bonnet, simply pull one side of the bonnet off the pad.

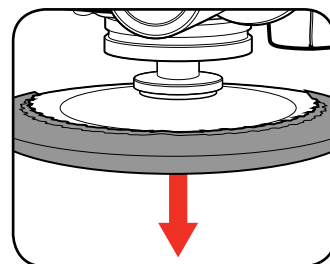

OPERATION

4. CONTROLS



WARNING! THE POWER SUPPLY FOR THIS PRODUCT SHOULD BE PROTECTED BY A RESIDUAL CURRENT DEVICE (RATED AT 30mA OR LESS).

Switching On/Off

- 1 Press and hold the lock-off button in.
- 2 Squeeze the on/off trigger to start the tool.

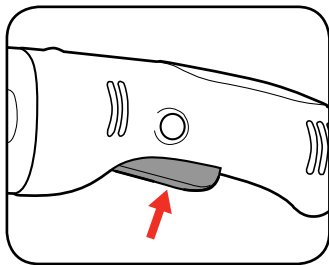
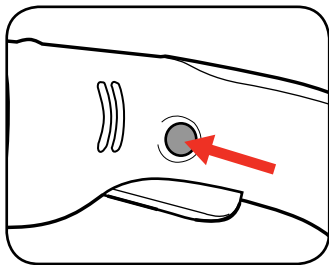

- 3 Once the tool has started, you can release the lock-off button.
- 4 To stop the tool release the on/off trigger.

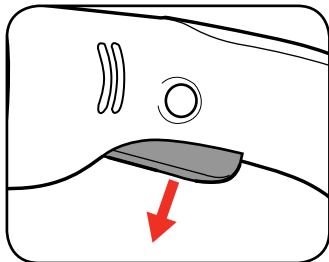
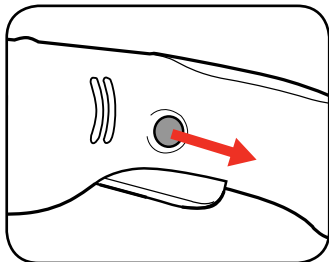

Variable Speed Dial

- 1 To increase the speed rotate the variable speed dial to a higher number.
- 2 To lower the speed rotate the variable speed dial to a lower number.

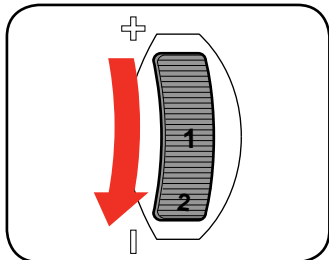
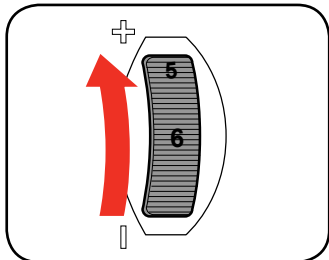

5. USING THE SANDER POLISHER

- 1 Attach the required disc for the job.

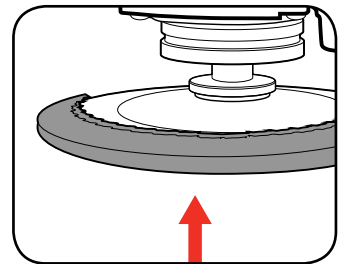

- 2 Set the variable speed dial to the desired setting.

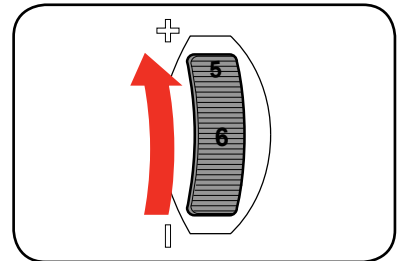

- 3 Ensure the workpiece is secured.

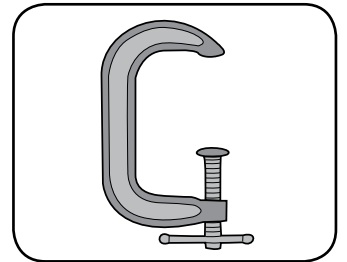

- 4 Hold the tool firmly, press the lock-off button and squeeze the on/off trigger.

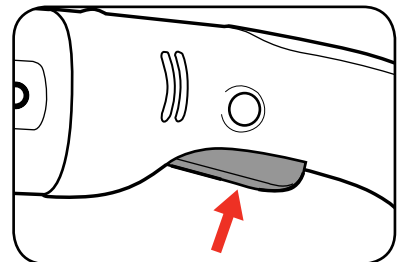

- 5 Lower the sander polisher disc onto the workpiece.

Note: Do not apply excess pressure, allow the tool to do all the work.

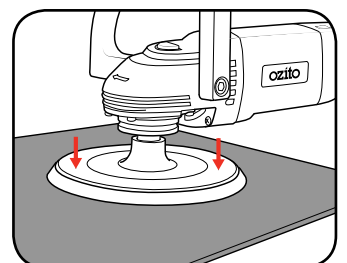

MAINTENANCE

- Keep the vents of the sander clean at all times. If possible, prevent foreign matter from entering the vents.
- After each use, blow air through the sander housing to ensure it is free from all dust particles which may build up. Build up of dust particles may cause the sander to overheat and fail.
- If the enclosure of the sander requires cleaning, do not use solvents but a moist soft cloth only. Never let any liquid get inside the sander; never immerse any part of the sander into a liquid.

Carbon Brushes

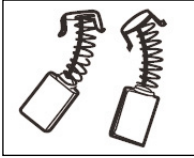

When the carbon brushes wear out, the sander polisher will spark and/or stop. Discontinue use as soon as this happens. They should be replaced prior to recommencing use of the sander polisher. Carbon brushes are a wearing component of the sander and are therefore not covered under warranty. Continuing to use the sander when carbon brushes need to be replaced may cause permanent damage

to the sander. Carbon brushes will wear out after many uses. When the carbon brushes need to be replaced, take the sander polisher to an electrician or a power tool repairer for a quick and low cost replacement. Always replace both carbon brushes at the same time.

Note: Ozito Industries will not be responsible for any damage or injuries caused by the repair of the sander polisher by an unauthorised person or by mishandling of the sander.

TROUBLE SHOOTING

Sparking visible through the housing air vents

A small amount of sparking may be visible through the housing vents. This is normal and does not indicate a problem.

Excessive sparking visible through the housing air vents and/or the drill failing to operate

May indicate the carbon brushes have worn out and need to be replaced. Carbon brushes should only be replaced by a qualified electrician or power tool repairer.

Sandpaper Selection

Selecting the correct grit of sandpaper is an important step in achieving optimum results. Coarse grit will remove the most material. Finer grit will produce a smoother finish. The condition of the workpiece will determine the grit of the sandpaper to be used. The higher the grit number, the finer the grade of sandpaper.

If the surface is rough, start with a coarse grit and sand until the surface is uniform. Medium grit may then be used to remove scratches left by the coarser grit. Finer grit is then used to finish the surface. Always continue sanding with each grade of sandpaper until the surface is uniform.

MATERIAL	APPROPRIATE GRIT	
	Coarse Sanding	Fine Sanding
Paintwork	180	400
Wood: Softwood	60	240
Hardwood	60	180
Veneer	240	320

Note: If intermediate sanding is required, choose a grit rating between coarse and fine. The above table is intended as a guide only. To ensure a satisfactory result, a small, inconspicuous area should first be tested to ensure the grit of sandpaper chosen is suitable for the desired finish.

Operation Tips

Never force the sander polisher. The weight of the unit supplies adequate pressure, allowing the discs to do the work. Applying additional pressure will slow the motor, rapidly wear the discs, and greatly reduce the rotational speed. This will slow the removal rate and produce an inferior quality surface.

CAUTION: Excessive pressure will overload the motor, causing possible damage to the sander polisher by overheating the motor; or damage to the workpiece. Be sure to check your workpiece often. The sander polisher is capable of removing material rapidly.

Do not sand or polish on one spot for too long. The sander's rapid action may remove too much material, creating an uneven surface.

DESCRIPTION OF SYMBOLS

V	Volts	Hz	Hertz
~	Alternating current	W	Watts
/min	Revolutions or reciprocation per minute	n	No load speed
	Double insulated		Regulator compliance mark
	Warning		Read instruction manual
	Wear eye protection		

CARING FOR THE ENVIRONMENT



Power tools that are no longer usable should not be disposed of with household waste but in an environmentally friendly way. Please recycle where facilities exist. Check with your local council authority for recycling advice.



Recycling packaging reduces the need for landfill and raw materials. Reuse of recycled material decreases pollution in the environment. Please recycle packaging where facilities exist. Check with your local council authority for recycling advice.

SPARE PARTS

Spare parts can be ordered from the Special Orders Desk at your local Bunnings Warehouse.

For further information, or any parts not listed here, visit www.ozito.com.au or contact Ozito Customer Service:

Australia 1800 069 486

New Zealand 0508 069 486

E-mail: enquires@ozito.com.au

ELECTRICAL SAFETY



WARNING! When using mains-powered tools, basic safety precautions, including the following, should always be followed to reduce risk of fire, electric shock, personal injury and material damage.

Read the whole manual carefully and make sure you know how to switch the tool off in an emergency, before operating the tool.

Save these instructions and other documents supplied with this tool for future reference.

The electric motor has been designed for 230V and 240V only. Always check that the power supply corresponds to the voltage on the rating plate.

Note: The supply of 230V and 240V on Ozito tools are interchangeable for Australia and New Zealand.



This tool is double insulated therefore no earth wire is required.

If the supply cord of this power tool is damaged, it must be replaced by a specially prepared cord available through the service organization.

Note: Double insulation does not take the place of normal safety precautions when operating this tool. The insulation system is for added protection against injury resulting from a possible electrical insulation failure within the tool.

Using an Extension Lead

Always use an approved extension lead suitable for the power input of this tool. Before use, inspect the extension lead for signs of damage, wear and ageing. Replace the extension lead if damaged or defective.

When using an extension lead on a reel, always unwind the lead completely. Use of an extension lead not suitable for the power input of the tool or which is damaged or defective may result in a risk of fire and electric shock.

To reduce the risk of electrical shock, a residual current device (rated 30mA or less) must be used.

GENERAL POWER TOOL SAFETY WARNINGS



WARNING! Read all safety warnings and all instructions. Failure to follow the warnings and instructions may result in electric shock, fire and/or serious injury.

Save all warnings and instructions for future reference. The term "power tool" in the warnings refers to your mains-operated (corded) power tool or battery-operated (cordless) power tool.

1. Work area safety

- Keep work area clean and well lit. Cluttered or dark areas invite accidents.
- Do not operate power tools in explosive atmospheres, such as in the presence of flammable liquids, gases or dust. Power tools create sparks which may ignite the dust or fumes.
- Keep children and bystanders away while operating a power tool. Distractions can cause you to lose control.

2. Electrical safety

- Power tool plugs must match the outlet. Never modify the plug in any way. Do not use any adapter plugs with earthed (grounded) power tools. Unmodified plugs and matching outlets will reduce risk of electric shock.
- Avoid body contact with earthed or grounded surfaces, such as pipes, radiators, ranges and refrigerators. There is an increased risk of electric shock if your body is earthed or grounded.
- Do not expose power tools to rain or wet conditions. Water entering a power tool will increase the risk of electric shock.
- Do not abuse the cord. Never use the cord for carrying, pulling or unplugging the power tool. Keep cord away from heat, oil, sharp edges or moving parts. Damaged or entangled cords increase the risk of electric shock.
- When operating a power tool outdoors, use an extension cord suitable for outdoor use. Use of a cord suitable for outdoor use reduces the risk of electric shock.
- If operating a power tool in a damp location is unavoidable, use a residual current device (RCD) protected supply. Use of an RCD reduces the risk of electric shock.

3. Personal safety

- Stay alert, watch what you are doing and use common sense when operating a power tool. Do not use a power tool while you are tired or under the influence of drugs, alcohol or medication. A moment of inattention while operating power tools may result in serious personal injury.
- Use personal protective equipment. Always wear eye protection. Protective equipment such as dust mask, non-skid safety shoes, hard hat, or hearing protection used for appropriate conditions will reduce personal injuries.

- Prevent unintentional starting. Ensure the switch is in the off-position before connecting to power source and/or battery pack, picking up or carrying the tool. Carrying power tools with your finger on the switch or energising power tools that have the switch on invites accidents.
 - Remove any adjusting key or wrench before turning the power tool on. A wrench or a key left attached to a rotating part of the power tool may result in personal injury.
 - Do not overreach. Keep proper footing and balance at all times. This enables better control of the power tool in unexpected situations.
 - Dress properly. Do not wear loose clothing or jewellery. Keep your hair, clothing and gloves away from moving parts. Loose clothes, jewellery or long hair can be caught in moving parts.
 - If devices are provided for the connection of dust extraction and collection facilities, ensure these are connected and properly used. Use of dust collection can reduce dust-related hazards.
- ## 4. Power tool use and care
- Do not force the power tool. Use the correct power tool for your application. The correct power tool will do the job better and safer at the rate for which it was designed.
 - Do not use the power tool if the switch does not turn it on and off. Any power tool that cannot be controlled with the switch is dangerous and must be repaired.
 - Disconnect the plug from the power source and/or the battery pack from the power tool before making any adjustments, changing accessories, or storing power tools. Such preventive safety measures reduce the risk of starting the power tool accidentally.
 - Store idle power tools out of the reach of children and do not allow persons unfamiliar with the power tool or these instructions to operate the power tool. Power tools are dangerous in the hands of untrained users.
 - Maintain power tools. Check for misalignment or binding of moving parts, breakage of parts and any other condition that may affect the power tool's operation. If damaged, have the power tool repaired before use. Many accidents are caused by poorly maintained power tools.
 - Keep cutting tools sharp and clean. Properly maintained cutting tools with sharp cutting edges are less likely to bind and are easier to control.
 - Use the power tool, accessories and tool bits etc. in accordance with these instructions, taking into account the working conditions and the work to be performed. Use of the power tool for operations different from those intended could result in a hazardous situation.
- ## 5. Service
- Have your power tool serviced by a qualified repair person using only identical replacement parts. This will ensure that the safety of the power tool is maintained.

SANDER POLISHER SAFETY WARNINGS

Safety Warnings common for Sanding or Polishing Operations:

- This power tool is intended to function as a sander or polisher. Read all safety warnings, instructions, illustrations and specifications provided with this power tool. Failure to follow all instructions listed below may result in electric shock, fire and/or serious injury.
- Operations such as grinding, wire brushing or cutting-off are not recommended to be performed with this power tool. Operations for which the power tool was not designed may create a hazard and cause personal injury.
- Do not use accessories which are not specifically designed and recommended by the tool manufacturer. Just because the accessory can be attached to your power tool, it does not assure safe operation.
- The rated speed of the accessory must be at least equal to the maximum speed marked on the power tool. Accessories running faster than their rated speed can break and fly apart.
- The outside diameter and the thickness of your accessory must be within the capacity rating of your power tool. Incorrectly sized accessories cannot be adequately guarded or controlled.
- Threaded mounting of accessories must match the spindle thread. Accessories that do not match the mounting hardware of the power tool will run out of balance, vibrate excessively and may cause loss of control.
- Do not use a damaged accessory. Before each use inspect the accessory such as a backing pad for cracks, tears or excess wear. If power tool or accessory is dropped, inspect for damage or install an undamaged accessory. After inspecting and installing an accessory, position yourself and bystanders away from the plane of the rotating accessory and run the power tool at maximum no-load speed for one minute. Damaged accessories will normally break apart during this test time.
- Wear personal protective equipment. Depending on application, use face shield, safety goggles or safety glasses. As appropriate, wear dust mask, hearing protectors, gloves and workshop apron capable of stopping small abrasive or work piece fragments. The eye protection must be capable of stopping flying debris generated by various operations. The dust mask or respirator must be capable of filtering particles generated by your operation. Prolonged exposure to high intensity noise may cause hearing loss.
- Keep bystanders a safe distance away from work area. Anyone entering the work area must wear personal protective equipment. Fragments of work piece or of a broken accessory may fly away and cause injury beyond immediate area of operation.
- Position the cord clear of the spinning accessory. If you lose control, the cord may be cut or snagged and your hand or arm may be pulled into the spinning accessory.
- Never lay the power tool down until the accessory has come to a complete stop. The spinning accessory may grab the surface and pull the power tool out of your control.
- Do not run the power tool while carrying it at your side. Accidental contact with the spinning accessory could snag your clothing, pulling the accessory into your body.
- Regularly clean the power tool's air vents. The motor's fan will draw the dust inside the housing and excessive accumulation of powdered metal may cause electrical hazards.
- Do not operate the power tool near flammable materials. Sparks could ignite these materials.
- Do not use accessories that require liquid coolants. Using water or other liquid coolants may result in electrocution or shock.

Kickback and Related Warnings

Kickback is a sudden reaction to a pinched or snagged rotating wheel, backing pad, brush or any other accessory. Pinching or snagging causes rapid stalling of the rotating accessory which in turn causes the uncontrolled power tool to be forced in the direction opposite of the accessory's rotation at the point of the binding.

For example, if an abrasive wheel is snagged or pinched by the work piece, the edge of the wheel that is entering into the pinch point can dig into the surface of the material causing the wheel to climb out or kick out. The wheel may either jump toward or away from the operator, depending on direction of the wheel's movement at the point of pinching. Abrasive wheels may also break under these conditions.

Kickback is the result of power tool misuse and/or incorrect operating procedures or conditions and can be avoided by taking proper precautions as given below.

- Maintain a firm grip on the power tool and position your body and arm to allow you to resist kickback forces. Always use auxiliary handle, if provided, for maximum control over kickback or torque reaction during start-up. The operator can control torque reactions or kickback forces, if proper precautions are taken.
- Never place your hand near the rotating accessory. Accessory may kickback over your hand.
- Do not position your body in the area where power tool will move if kickback occurs. Kickback will propel the tool in direction opposite to the wheel's movement at the point of snagging.
- Use special care when working corners, sharp edges etc. Avoid bouncing and snagging the accessory. Corners, sharp edges or bouncing have a tendency to snag the rotating accessory and cause loss of control or kickback.
- Do not attach a saw chain woodcarving blade or toothed saw blade. Such blades create frequent kickback and loss of control.

Safety Warnings Specific for Sanding Operations

- Do not use excessively oversized sanding disc paper. Follow manufacturers recommendations, when selecting sanding paper. Larger sanding paper extending beyond the sanding pad presents a laceration hazard and may cause snagging, tearing of the disc or kickback.

Safety Warnings Specific for Polishing Operations

- Do not allow any loose portion of the polishing bonnet or its attachment strings to spin freely. Tuck away or trim any loose attachment strings. Loose and spinning attachment strings can entangle your fingers or snag the work piece.

SPARE PARTS

Tool: 180mm Sander Polisher
Model No. SPR-7100

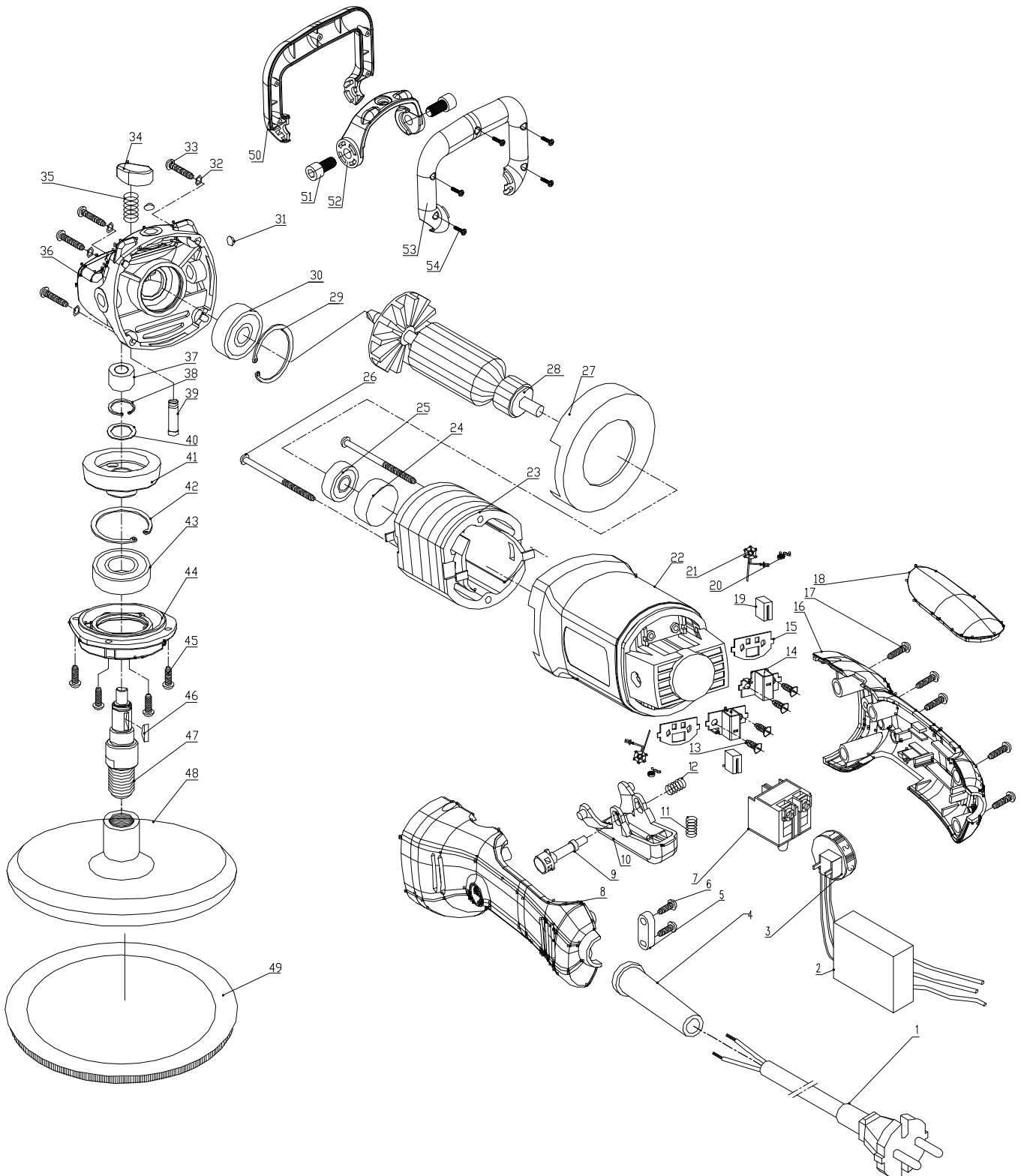

How To Order

Available spare parts can be ordered through the Special Orders Desk at any Bunnings Warehouse. If you have any further questions, please contact Ozito Customer Service on:

Australia: 1800 069 486

New Zealand: 0508 069 486

enquiries@ozito.com.au

WARRANTY

IN ORDER TO MAKE A CLAIM UNDER THIS WARRANTY YOU MUST RETURN THE PRODUCT TO YOUR NEAREST BUNNINGS WAREHOUSE WITH YOUR BUNNINGS REGISTER RECEIPT. PRIOR TO RETURNING YOUR PRODUCT FOR WARRANTY PLEASE TELEPHONE OUR CUSTOMER SERVICE HELPLINE:

Australia 1800 069 486

New Zealand 0508 069 486

TO ENSURE A SPEEDY RESPONSE PLEASE HAVE THE MODEL NUMBER AND DATE OF PURCHASE AVAILABLE. A CUSTOMER SERVICE REPRESENTATIVE WILL TAKE YOUR CALL AND ANSWER ANY QUESTIONS YOU MAY HAVE RELATING TO THE WARRANTY POLICY OR PROCEDURE.

The benefits provided under this warranty are in addition to other rights and remedies which are available to you at law.

Our goods come with guarantees that cannot be excluded at law. You are entitled to a replacement or refund for a major failure and for compensation for any other reasonably foreseeable loss or damage. You are also entitled to have the goods repaired or replaced if the goods fail to be of acceptable quality and the failure does not amount to a major failure.

Generally you will be responsible for all costs associated with a claim under this warranty, however, where you have suffered any additional direct loss as a result of a defective product you may be able to claim such expenses by contacting our customer service helpline above.

3 YEAR REPLACEMENT WARRANTY

Your product is guaranteed for a period of **36 months from the original date of purchase** and is intended for DIY (Do It Yourself) use only. If a product is defective it will be replaced in accordance with the terms of this warranty. Warranty excludes consumable parts, for example: carbon brushes, backing pads, etc.

WARNING

The following actions will result in the warranty being void.

- If the tool has been operated on a supply voltage other than that specified on the tool.
- If the tool shows signs of damage or defects caused by or resulting from abuse, accidents or alterations.
- Failure to perform maintenance as set out within the instruction manual.
- If the tool is disassembled or tampered with in any way.
- Professional, industrial or high frequency use.