

GB **Operating Instructions**
Petrol Chain Saw

 **SPEAR & JACKSON**

7

CE

Cat-No.: 720-1431

45.014.34

I.-No.: 01016

SPJCS 38



- Ⓢ Please read these instructions carefully before installing and operating the petrol motor scythe!

Petrol Engine Quick Start Guide

Ensure correct fuel/oil mixture 40:1

STARTING

1. add fuel and chain oil.
2. switch ignition to "I" (on)
3. take brake Off.
4. lock throttle lever on.
5. pull choke fully out.
6. pull starter cord 5 times (primes the engine)
7. push choke in halfway.
Note - the amount of Choke will vary slightly depending on the weather conditions, a small amount of experimentation is advised.
8. pull starter cord
9. allow engine to warm up at half throttle for a short time and push the choke in.
Note - this quick start guide is intended for experienced users who have already assembled the tool, please refer to the manual for details.

If machine does not start after minimum 6 pulls on starter cord refer to petrol Engine Q & A on page 16.

General Safety Rules

	Read the user manual before using the machine		Wear safety shoes to protect your feet.
	On all jobs performed with the saw you must always wear safety goggles to guard your eyes from flying materials/objects and a sound-proof helmet, ear plugs or the like to protect your hearing. Wear a safety helmet if there is a risk of objects falling on you from above.		Protect yourself from saw kickback. Hold the chain saw securely with both hands during use.
			Make sure that the chain brake is released. Pull back the handle/chain brake before operating.
			Noise emission complies with Directive 2000/14/EC!
	Wear gloves to protect your hands.		Warning! Danger!

WARNING! When using gas tools, basic safety precautions, including the following, should always be followed to reduce the risk of serious personal injury and/or damage to the unit. Read all these instructions before operating this product and save these instructions.

- DO NOT operate a chain saw with one hand! Serious injury to the operator, helpers, bystanders, or any combination of these persons may result from one-handed operation. A chain saw is intended for two-handed use.
- DO NOT operate a chain saw when you are fatigued.
- Use safety footwear, snug-fitting clothing, protective gloves, and eye, hearing and head protection devices.
- Use caution when handling fuel. Move the chain saw at least 10 feet (3m) from the fueling point before starting the engine.
- DO NOT allow other persons to be near when starting or cutting with the chain saw. Keep bystanders and animals out of the work area.
- DO NOT start cutting until you have a clear work area, secure footing, and a planned retreat path from the falling tree.
- Keep all parts of your body away from the saw chain when the engine is running.
- Before you start the engine, make sure that the saw chain is not contacting anything.
- Carry the chain saw with the engine stopped, the guide bar and saw chain to the rear, and the silencer away from your body.
- NEVER use a chainsaw which is damaged, incorrectly set or incompletely and loosely assembled. Make sure that the chainsaw is switched off when releasing the chain brake.
- Shut off the engine before setting the chain saw down.
- Use extreme caution when cutting small size brush and saplings because slender material may catch the saw chain and be whipped toward you or pull you off balance.
- When cutting a limb that is under tension, be alert for springback so that you will not be struck when the tension in the wood fibers is released.
- Keep the handles dry, clean, and free of oil or fuel mixture.
- Operate the chain saw only in well-ventilated areas.
- DO NOT operate a chain saw in a tree unless you have been specifically trained to do so.
- All chain saw service, other than the items listed in the user manual safety and maintenance instructions, should be performed by competent chain saw service personnel.
- When transporting your chain saw, use the appropriate guide bar scabbard.
- DO NOT operate your chain saw near or around flammable liquids or gases whether in or out of doors. An explosion and/or fire may result.
- Do not tank fuel, oil or lubrication when the engine of chain saw is running.
- USE THE RIGHT TOOL: Cut wood only. Do not use the chain saw for purposes for which it was not intended. For example, do not use the chain saw for cutting plastic, masonry, or nonbuilding materials.
- Use a container approved for fuel. Do not smoke or allow smoking near fuel or unit. Avoid spillages of fuel or oil, wipe up all spillages. Move at least 3 metres away from fuelling site before starting engine.

NOTE: This appendix is intended primarily for the consumer or occasional user. These models are intended for infrequent use by homeowners,

GB

cottagers, and campers, and for such general applications as clearing, pruning, cutting firewood, etc. They are not intended for prolonged use. If the intended use involves prolonged periods of operation, this may cause circulatory problems in the user's hands due to vibration. It may be appropriate to use a saw having an anti-vibration feature such as the models covered in this manual with the suffix Anti-Vibration.

KICKBACK SAFETY PRECAUTIONS

Kickback may occur when the nose or tip of the guide bar touches an object, or when the wood closes in and pinches the saw chain in the cut. If the bar tip contacts, it may cause a lightning-fast reverse reaction, kicking the guide bar up and back towards the operator. Pinching the saw chain along the top of the guide bar may push the guide bar rapidly back towards the operator. Either of these reactions may cause you to lose control of the saw, which could result in serious personal injury. Do not rely exclusively upon the safety devices built into your saw. As a chain saw user, you should take several steps to keep your cutting jobs free from accident or injury.

1. With a basic understanding of kickback, you can reduce or eliminate the element of surprise. Sudden surprise contributes to accidents.
2. Keep a good firm grip on the saw with both hands, the right hand on the rear handle, and the left hand on the front handle, when the engine is running. Use a firm grip with thumbs and fingers encircling the chain saw handles. A firm grip will help you reduce kickback and maintain control of the saw. Don't let go.
3. Make sure that the area in which you are cutting is free from obstructions. Do not let the nose of the guide bar contact a log, branch, or any other obstruction which could be hit while you are operating the saw.
4. Cut at high engine speeds.
5. Do not overreach or cut above shoulder height.
6. Follow manufacturer's sharpening and maintenance instructions for the chain saw.
7. Only use replacement bars and chains specified by the manufacturer or the equivalent.

NOTE: Low-kickback saw chain is chain that has met the kickback performance.

IMPORTANT SAFETY

A safety sign is fitted to the chain saw's fan filter cover. This label, along with the safety instructions on these pages, should be carefully read before attempting to operate this unit.

HOW TO READ SYMBOLS AND COLORS (FIG. 1)

⚠ WARNING: RED Used to warn that an unsafe procedure should not be performed.

GREEN RECOMMENDED



Recommended cutting procedure.

WARNING

1. Beware of kick back.
2. Do not attempt to hold saw with one hand.
3. Avoid bar nose contact. **RECOMMENDED**
4. Hold Saw properly with both hands.

● DANGER! BEWARE OF KICKBACK!

⚠ WARNING: Kickback can lead to dangerous loss of control of the chain saw and result in serious or fatal injury to the saw operator or to anyone standing close by. Always be alert. Rotational kickback and pinch-kickback are major chain saw operational dangers and the leading cause of most accidents.

KICKBACK may occur when the **NOSE** or **TIP** of the guide bar touches an object, or when wood closes in and pinches the saw chain in the cut.

Tip contact in some cases may cause a lightning-fast reverse reaction, kicking the guide bar up and back toward the operator.

PINCHING the saw chain along the **BOTTOM** of the guide bar may **PULL** the saw forward away from the operator. **PINCHING** the saw chain along the **TOP** of the guide bar may **PUSH** the guide bar rapidly back toward the operator.

Any of these reactions may cause you to lose control of the saw, which could result in serious personal injury.

BEWARE OF:

ROTATIONAL KICKBACK
(Fig. 2A)

A = Kickback path

B = Kickback reaction zone

**THE PUSH
(PINCH KICKBACK)
AND PULL
REACTIONS**
(Fig. 2B)

A = Pull

B = Solid objects

C = Push

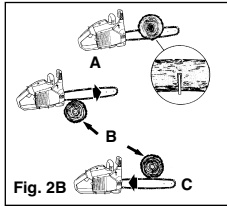
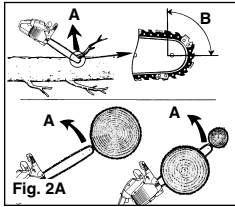

TECHNICAL DATA

Engine displacement	38 cm ³
Maximum drive power	1,4 kW
Cutting length	37 cm
Cutter rail length	16" (40cm)
Chain gap	(3/8"), 10 mm
Chain thickness	(0,05"), 1,27 mm
Idle speed	3,100 min ⁻¹ ± 10%
max. Speed with cutting unit	8000 min ⁻¹
Tank capacity	296 ml
Oil tank capacity	180 ml
Anti-vibration function	Yes
Teeth of sprocket wheel	6
Chain brake	Yes
Clutch	Yes
Automatic chain lubrication	Yes
Low-kickback chain	Yes
Net weight without chain and chain bar	5.1 kg
Net weight (dry)	5,88 kg
Petrol consumption (specific)	approx. 1250 g/kWh
Sound pressure level L _{pA}	101 dB(A)
Working pressure level L _{WA}	113 dB(A)
Vibration a _{hv}	max. 11,0 m/s ²
Replacement chain	see spare-part list
Replacement chain bar	see spare-part list
Spark plug	Champion RDJ7Y

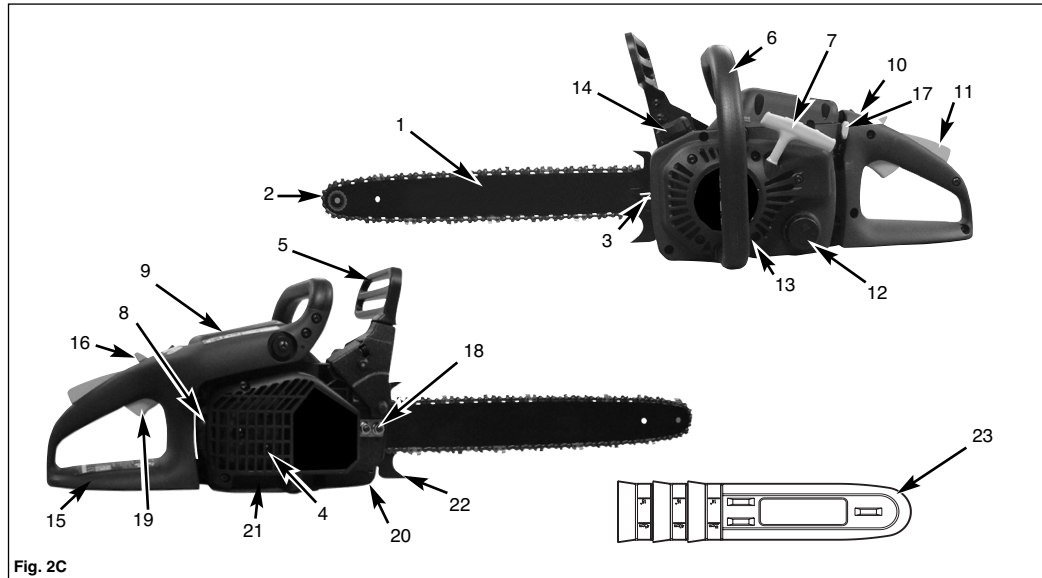

Fig. 2C

GB**GENERAL INFORMATION (FIG. 2C)**

1. Chain bar
2. Saw chain
3. Chain tensioning screw
4. Spark mesh (inside exhaust)
5. Chain brake lever / front hand guard
6. Front handle
7. Starter handle
8. Spark plug
9. Air filter cover
10. Stop switch
11. Safety lock
12. Oil tank cap
13. Fan housing
14. Fuel tank cap
15. Rear handle / bootstrap
16. Operating switch
17. Choke / (carburetor setting)
18. Bar fastening nut
19. Throttle lever
20. Chain catch
21. Exhaust cover
22. Stop claw
23. Chain guard

ACCESSOIRES

- 1 bottle 2-stroke oil
- 1 bottle chain oil
- 1 sparking plug spanner
- 1 fuel mixing bottle

SAFETY FEATURES

Numbers preceding the descriptions correspond with the numbers on preceding page to help you locate the safety feature.

- 2 LOW KICKBACK SAW CHAIN** helps significantly reduce kickback, or the intensity of kickback, due to specially designed depth gauges and guard links.
- 5 CHAIN BRAKE LEVER / HAND GUARD** protects the operator's left hand in the event it slips off the front handle while saw is running.
- 5 CHAIN BRAKE** is a safety feature designed to reduce the possibility of injury due to kickback by stopping a moving saw chain in milliseconds. It is activated by the CHAIN BRAKE lever.
- 10 STOP SWITCH** immediately stops the engine when tripped. Stop switch must be pushed to ON position to start or restart engine.
- 11 SAFETY TRIGGER** prevents accidental acceleration of the engine. Throttle trigger (19) cannot be squeezed unless the safety latch is depressed.

20 CHAIN CATCHER reduces the danger of injury in the event saw chain breaks or derails during operation. The chain catcher is designed to intercept a whipping chain.

NOTE: Study your saw and be familiar with its parts.

ASSEMBLY INSTRUCTIONS**● TOOLS FOR ASSEMBLY**

You will need these tools to assemble your chain saw:

1. Ring wrench SW 11
2. Screwdriver / spark plug wrench

Assembly Requirements

⚠ WARNING: DO NOT start saw engine until unit is properly prepared.

Your new chain saw will require adjustment of chain, filling the fuel tank with correct fuel mixture and filling the oil tank with lubricating oil before the unit is ready for operation.

Read the entire user manual before attempting to operate your unit. Pay particular attention to all safety precautions.

This manual contains not only safety information but also general information on how to assemble, operate and service the saw.

● GUIDE BAR / SAW CHAIN / CLUTCH COVER INSTALLATION

⚠ WARNING: Always wear protective gloves when handling chain.

TO INSTALL GUIDE BAR:

To ensure the bar and chain receive oil, **ONLY USE THE ORIGINAL STYLE BAR** with the oil passage hole (A) as illustrated above (Fig. 3A).

1. Make sure the Chain brake lever is pulled back into the DISENGAGED position (Fig. 3B)
2. Remove the bar fastening nut (B). Remove the 2 screws of the chain brake cover (C). Remove the **chain brake cover** by pulling it straight out with a strong tug (Fig. 3C).

Note: The chain may sag a little. This is normal.

3. Using a screwdriver, run the adjustment screw (D) COUNTERCLOCKWISE until the TANG (E) (projecting prong) is to the end of its travel toward the clutch drum and sprocket (Fig. 3D).
4. Place the slotted end of the guide bar over the bar bolts (F). Position the bar so that the adjustment TANG fits into the lower hole (G) on the guide bar (Fig. 3E).

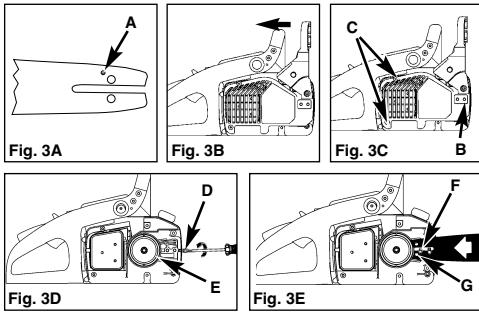

TO INSTALL SAW CHAIN:

1. Spread chain out in a loop with cutting edges (A) pointing CLOCKWISE around loop (Fig. 4A).
2. Slip the chain around the sprocket (B) behind the clutch (C). Make sure the links fit between the sprocket teeth (Fig. 4B).
3. Guide the drive links into the groove and around the end of the bar (Fig. 4B).
NOTE: The saw chain may droop slightly on the lower part of bar. This is normal.
4. Pull the chain bar forward until the chain is closely seated. Make sure that all the drive links are in the groove of the bar.
5. Install the clutch cover and tighten the 2 screws. Make sure the chain does not slip off of the bar. Install the 2 nuts hand tight and follow tension adjustment instructions in Section **SAW CHAIN TENSION ADJUSTMENT**.

NOTE: The guide bar retaining nuts are installed only hand tight at this point because saw chain adjustment is required. Follow instructions in Section **SAW CHAIN TENSION ADJUSTMENT**.

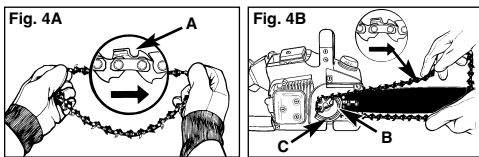

● **SAW CHAIN TENSION ADJUSTMENT**

Proper tension of saw chain is extremely important and must be checked before starting, as well as during any cutting operation. Taking the time to make needed adjustments to the saw chain will result in improved cutting performance and prolonged chain life.

⚠ WARNING: Always wear heavy duty gloves when handling saw chain or making saw chain adjustments.

TO ADJUST SAW CHAIN:

1. Hold nose of guide bar up and turn adjustment screw (D) CLOCKWISE to increase chain tension. Turning screw COUNTERCLOCKWISE will decrease amount of tension on chain. Ensure the chain fits snugly all the way around the guide bar (Fig. 5).
2. After making adjustment, and while still holding nose of bar in the uppermost position, tighten the bar retaining nuts securely. Chain has proper tension when it has a snug fit all around and can be pulled around by gloved hand.

NOTE: If chain is difficult to rotate on guide bar or if it binds, too much tension has been applied. This requires minor adjustment as follows:

- A. Loosen the bar retaining nut so they are finger tight. Decrease tension by turning the bar adjustment screw COUNTERCLOCKWISE slowly. Move chain back and forth on bar. Continue to adjust until chain rotates freely, but fits snugly. Increase tension by turning bar adjustment screw CLOCKWISE.
- B. When saw chain has proper tension, hold nose of bar in the uppermost position and tighten the bar retaining nut securely.

⚠ CAUTION: A new saw chain stretches, requiring adjustment after as few as 5 cuts. This is normal with a new chain, and the interval between future adjustments will lengthen quickly.

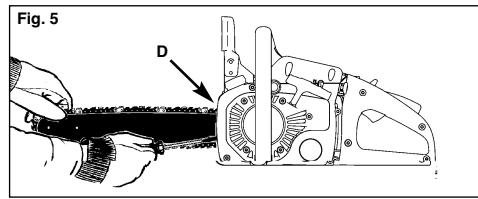

⚠ CAUTION: If saw chain is TOO LOOSE or TOO TIGHT, the sprocket, bar, chain, and crankshaft bearings will wear more rapidly.

Note: In any case do not tighten the chain immediately after use, but wait until it cools down, it should be possible to lift the chain in the middle of bar approx. 3 mm when chain cooled (Fig. 6).

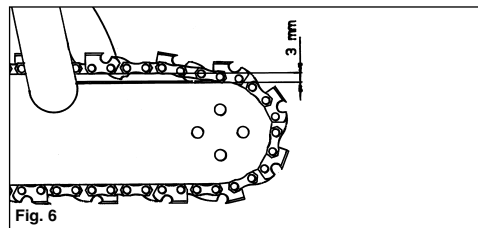

GB**CHAIN BRAKE MECHANICAL TEST**

Your chain saw is equipped with a Chain brake that reduces possibility of injury due to kickback. The brake is activated if pressure is applied against brake lever when, as in the event of kickback, operator's hand strikes the lever. When the brake is actuated, chain movement stops abruptly.

⚠WARNING: The purpose of the chain brake is to reduce the possibility of injury due to kickback; however, it cannot provide the intended measure of protection if the saw is operated carelessly. Always test the chain brake before using your saw and periodically while on the job.

TO TEST CHAIN BRAKE:

1. The Chain brake is **DISENGAGED** (chain can move) when **BRAKE LEVER IS PULLED BACK AND LOCKED** (Fig. 7A).
2. The Chain brake is **ENGAGED** (chain is stopped) when brake lever is in forward position. You should not be able to move chain (Fig. 7B).

NOTE: The brake lever should snap into both positions. If strong resistance is felt, or lever does not move into either position, do not use your saw. Take it immediately to a professional Service Center for repair.

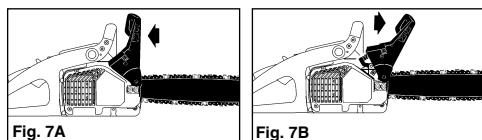

Fig. 7A

Fig. 7B

FUEL AND LUBRICATION**FUEL**

Use regular grade unleaded gasoline mixed with 40:1 custom 2-stroke cycle oil for best results.

- Start the machine at least 3 m away from the refueling site to avoid the possible risk of fire.
- Do not smoke whilst refueling or working with the machine.
- Do not use the hedge trimmer near inflammable liquids or gases. This could result in an explosion and/or fire.

⚠WARNING: Never use straight gasoline in your unit. This will cause permanent engine damage and void the manufacturer's warranty for that product.

⚠WARNING: Never use a fuel mixture that has been stored for over 90 days.

⚠WARNING: If 2-cycle lubricant is to be used, it must be a premium grade oil for 2-cycle air cooled engines mixed at a 40:1 ratio. Do not use any 2-cycle oil product with a recommended mixing ratio of 100:1. If insufficient lubrication is the cause of engine damage, it voids the

8

manufacturer's engine warranty for that occurrence.

MIXING FUEL

Mix the fuel with the enclosed mixing bottle. Pour the correct quantities of petrol and 2-stroke oil into the mixing bottle (see scale printed on the bottle). Then shake the bottle well.

⚠WARNING: Lack of lubrication voids engine warranty.

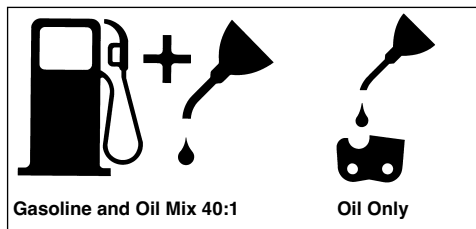
FUEL AND LUBRICATION

Gasoline and Oil Mix 40:1

Oil Only

RECOMMENDED FUELS

Some conventional gasolines are being blended with oxygenates such as alcohol or an ether compound to meet clean air standards. Your engine is designed to operate satisfactorily on any gasoline intended for automotive use including oxygenated gasolines. It is recommended to use unleaded petrol as fuel.

CHAIN AND BAR LUBRICATION

Always refill the chain oil tank each time the fuel tank is refilled. We recommend using Chain, Bar and Sprocket Oil, which contains additives to reduce friction and wear and to assist in the prevention of pitch formation on the bar and chain.

OPERATING INSTRUCTIONS**ENGINE PRE-START CHECKS**

⚠WARNING: Never start or operate the saw unless the bar and chain are properly installed. Ensure that chain brake is unlocked.

1. Fill the fuel tank (A) with correct fuel mixture (Fig. 8).
2. Fill the oil tank (B) with correct chain and bar oil (Fig. 8).
3. Be certain the chain brake is disengaged (C) before starting unit (Fig. 8).

Helpline No: UK 0151 649 1500 / IRE 189 094 6244

TO START ENGINE

The choke has 3 positions: RUN (A), HALF (B) and CHOKE (C) (Fig. 9A).

- Slide red STOP switch up for starting (Fig. 9B).
- Move the yellow choke lever (E) to |+| (CHOKE) (Fig. 9C).
- Push the primer bulb (F) 10 times (Fig. 9D).
- Push the operating lock forward: Press on the operating lock (I) with your right hand and pull the throttle lever (H) with your index finger. Now push the lever catch (G) forward, keep it pressed and release the throttle lever (H). The throttle lever (H) then locks into place in the "half throttle" position (Fig. 9I).
- Place saw on a firm, flat surface. Hold saw firmly as shown. Pull starter rapidly 4 times. Beware of moving chain! (Fig.9F)
- Move yellow choke lever (D) to |+/| (HALF) (Fig.9G).
- Hold saw firmly and pull starter rapidly 4 times. Engine should start (Fig. 9H).
- Warm up for 10 seconds. Depress and release trigger (H) for IDLE, then go to step 9 (Fig. 9I).
- Move yellow choke lever (F) to |+| (RUN) (Fig. 9J). If engine failed to start, repeat these instructions.

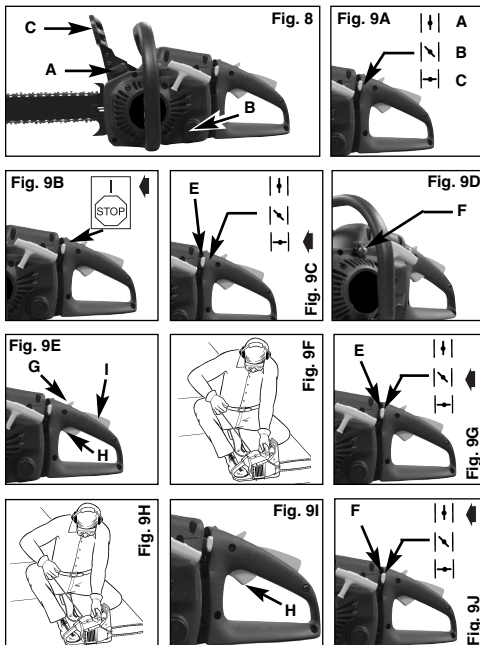
**RE-STARTING A WARM ENGINE**

- Make sure the switch is in the ON position.
- Move the choke lever to |+/| (HALF).
- Depress the primer bulb 10 times.
- Set the throttle latch.
- Pull the starter rope rapidly 4 times. The engine should start.
- Move the choke lever to |+| (RUN).
- Release the throttle latch.

TO STOP ENGINE

- Release trigger and allow engine to return to idle speed.
- Move STOP switch down to stop engine.

NOTE: For emergency stopping, simply activate chain brake and move STOP switch down.

CHAIN BRAKE OPERATIONAL TEST

Test the chain brake periodically to ensure proper function.

Perform a chain brake test prior to initial cutting, following extensive cutting, and definitely following any Chain brake service.

TEST CHAIN BRAKE AS FOLLOWS (Fig. 10) :

- Place saw on a clear, firm, flat surface.
- Start engine.
- Grasp the rear handle (A) with your right hand.
- With your left hand, hold the front handle (B) [not chain brake lever (C)] firmly.
- Squeeze the throttle trigger to 1/3 throttle, then immediately activate the chain brake lever (C).

⚠ WARNING: Activate the chain brake slowly and deliberately. Keep the chain from touching anything; don't let the saw tip forward.

- Chain should stop abruptly. When it does, immediately release the throttle trigger.

⚠ WARNING: If chain does not stop, turn engine off and take your unit to the nearest Authorized Service Center for service.

- If chain brake functions properly, turn the engine off and return the chain brake to the DISENGAGED position.

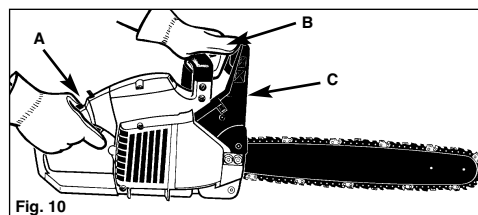

⚠WARNING: Before making the final cut, always recheck the area for bystanders, animals or obstacles.

FELLING CUT:

1. Use wooden or plastic wedges (A) to prevent binding the bar or chain (B) in the cut. Wedges also control felling (Fig. 14A).
2. When diameter of wood being cut is greater than the bar length, make 2 cuts as shown (Fig. 14B).

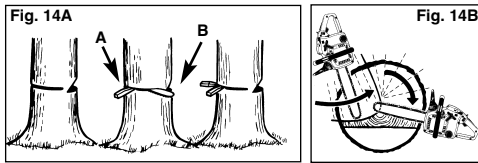

⚠WARNING: As the felling cut gets close to the hinge, the tree should begin to fall. When tree begins to fall, remove saw from cut, stop engine, put chain saw down, and leave area along retreat path (Fig. 12).

LIMBING

Limbing a tree is the process of removing the branches from a fallen tree. Do not remove supporting limbs (A) until after the log is bucked (cut) into lengths (Fig. 15). Branches under tension should be cut from the bottom up to avoid binding the chain saw.

⚠WARNING: Never cut tree limbs while standing on tree trunk.

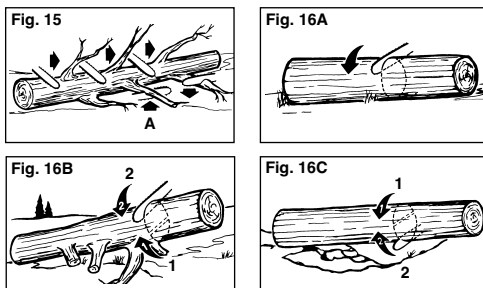

BUCKING

Bucking is cutting a fallen log into lengths. Make sure you have a good footing and stand uphill of the log when cutting on sloping ground. If possible, the log should be supported so that the end to be cut off is not resting on the ground. If the log is supported at both ends and you must cut in the middle, make a downward cut halfway through the log and then make the undercut. This will prevent the log from pinching the bar and chain. Be careful that the chain does not cut into the ground when bucking as this

causes rapid dulling of the chain.

When bucking on a slope, always stand on the uphill side.

1. Log supported along entire length: Cut from top (overbuck), being careful to avoid cutting into the ground (Fig. 16A).
2. Log supported on 1 end: First, cut from bottom (underbuck) 1/3 diameter of log to avoid splintering. Second, cut from above (overbuck) to meet first cut and avoid pinching (Fig. 16B).
3. Log supported on both ends: First, overbuck 1/3 diameter of log to avoid splintering. Second, underbuck to meet first cut and avoid pinching (Fig. 16C).

NOTE: The best way to hold a log while bucking is to use a sawhorse. When this is not possible, the log should be raised and supported by the limb stumps or by using supporting logs. Be sure the log being cut is securely supported.

BUCKING USING A SAWHORSE

For personal safety and ease of cutting, the correct position for vertical bucking is essential (Fig. 17).

VERTICAL CUTTING:

- A. Hold the saw firmly with both hands and keep the saw to the right of your body while cutting.
- B. Keep the left arm as straight as possible.
- C. Keep weight on both feet.

⚠CAUTION: When working with the saw, always make sure that the saw chain and chain bar are sufficiently lubricated.

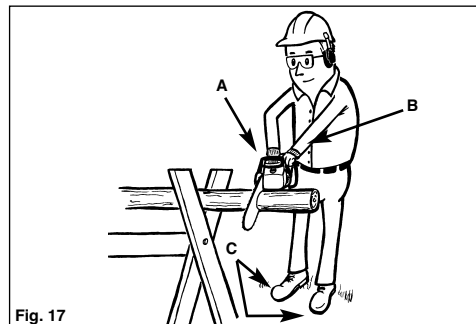

GB**MAINTENANCE INSTRUCTIONS**

All chain saw service, other than items listed here in your user manual maintenance instructions, should be performed professional.

PREVENTIVE MAINTENANCE

A good preventive maintenance program of regular inspection and care will increase life and improve performance of your Talon chain saw. This maintenance checklist is a guide for such a program. Cleaning, adjustment, and parts replacement may be required, under certain conditions, at more frequent intervals than those indicated.

Maintenance CHECKLIST		EACH USE	HOURS OF OPERATION	
ITEM	ACTION		✓	10 20
Screws/Nuts/Bolts	Inspect/Tighten		✓	
Air Filter	Clean or Replace			✓
Fuel Filter/Oil Filter	Replace		✓	
Spark Plug	Clean/Adjust/Replace		✓	
Spark Arrester Screen	Inspect		✓	
Fuel Hoses	Inspect	✓		
	Replace as Required			
Chain brake components	Inspect	✓		
	Replace as Required			

AIR FILTER

CAUTION: Never operate saw without the air filter. Dust and dirt will be drawn into engine and damage it. Keep the air filter clean!

TO CLEAN AIR FILTER:

1. Remove the top cover (A) by loosening the cover retaining screws. Cover will lift off. (Fig. 18)
2. Lift the air filter (B) out of air-box (C) (Fig. 18).
3. Clean air filter. Wash filter in clean, warm, soapy water. Rinse in clear, cool water. Air dry completely.

NOTE: It is advisable to have a supply of spare filters.

4. Install air filter. Install engine / air filter cover. Make sure cover fits properly. Tighten the cover retaining screws securely.

WARNING: Never perform maintenance when the engine is hot, to avoid any chance of burning hands or fingers.

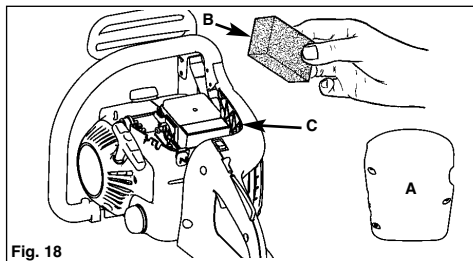

Fig. 18

FUEL FILTER

CAUTION: Never use the saw without a fuel filter. After 20 hours in operation the fuel filter should be cleaned or, in case of damage, replaced. Be sure to empty the fuel tank before changing the filter.

1. Remove the fuel tank cap.
2. Bend a piece of soft wire.
3. Reach into fuel tank opening and hook fuel line. Carefully pull the fuel line toward the opening until you can reach it with your fingers.

NOTE: Do not pull hose completely out of tank.

4. Lift filter (A) out of tank (Fig. 19).
5. Pull off the filter with a twist and clean it; if the filter is damaged, dispose of it.
6. Insert a new filter. Place one end of the filter into the tank opening. Make sure that the filter is seated in the lower corner of the tank. If necessary, use a long screwdriver to move the filter to its correct position, taking care not to damage in the process.
7. Fill tank with fresh fuel / oil mixture. See Section **FUEL AND LUBRICATION**. Install fuel cap.

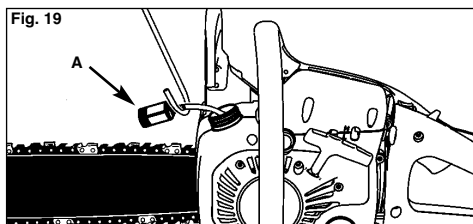

Fig. 19

SPARK ARRESTER SCREEN (Fig. 20A)

NOTE: A clogged spark arrester screen will dramatically reduce engine performance.

1. Remove the 2 bar retaining nuts (A) and loosen the 2 screws (B) that secure the chain brake cover (Fig. 20A).
2. Remove the chain brake cover. Remove the 3 screws that hold the silencer to the cylinder. The silencer will lift off after retaining screws are removed (Figure 20B).
3. Separate silencer halves (C). Remove the metal

- baffles (D) and spacer tubes (E).
- Discard the used spark arrester screen and replace it with a new one (F) (Fig. 20B).
 - Reassemble the silencer components and install the silencer to the cylinder. Tighten screws securely.

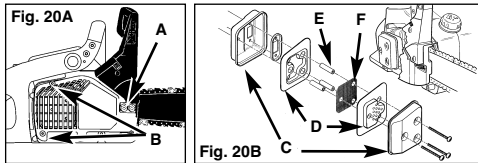

SPARK PLUG

NOTE: For efficient operation of saw engine, spark plug must be kept clean and properly gapped.

- Push STOP switch down.
- Remove the cover by undoing the cover fastening screws (Fig. 21).
- Disconnect the ignition cable (A) from the spark plug by pulling and twisting it simultaneously (Fig. 21).
- Reinstall a new spark plug, gapped at 0.6mm.

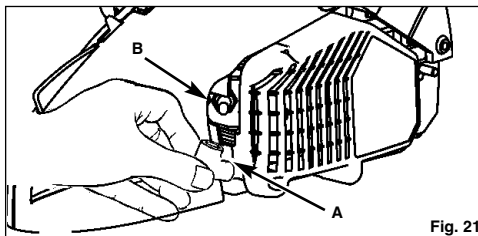

CARBURETOR ADJUSTMENT

The carburetor was pre-set at the factory for optimum performance. If further adjustments are necessary, please take your unit to the nearest professional.

STORING A CHAIN SAW

CAUTION: Never put a chain saw into storage for longer than 30 days without carrying out the following steps.

Storing a chain saw for longer than 30 days requires storage maintenance. Unless the storage instructions are followed, fuel remaining in the carburetor will evaporate, leaving gum-like deposits. This could lead to difficult starting and result in costly repairs.

- Remove the fuel tank cap slowly to release any pressure in tank. Carefully drain the fuel tank.
- Start the engine and let it run until the unit stops to remove fuel from carburetor.

- Allow the engine to cool (approx. 5 minutes).
- Using a spark plug wrench, remove the spark plug.
- Pour 1 teaspoon of clean 2-cycle oil into the combustion chamber. Pull starter rope slowly several times to coat internal components.

Replace spark plug (Fig. 22).

NOTE: Store the unit in a dry place and away from possible sources of ignition such as a furnace, gas hot water heater, gas dryer, etc.

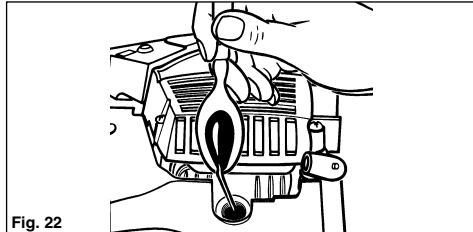

PUTTING THE SAW BACK INTO OPERATION

- Remove spark plug.
- Pull starter rope briskly to clear excess oil from combustion chamber.
- Clean the spark plug and check that the electrode gap is correct.
- Prepare unit for operation.
- Fill fuel tank with proper fuel / oil mixture. See **FUEL AND LUBRICATION** Section.

CHAIN BAR MAINTENANCE

Regular lubrication of the chain bar (guide rail for the chain and teeth) is essential. The chain bar needs the maintenance described in the following section in order for the saw to work at an optimum level of performance.

CAUTION: The sprocket tip on your new saw has been pre-lubricated at the factory. Failure to lubricate the guide bar sprocket tip as explained below will result in poor performance and seizure, voiding the manufacturer's warranty.

TOOLS FOR LUBRICATION:

A Lube Gun is recommended for applying grease to the guide bar sprocket tip. A Lube Gun is equipped with a needle nose tip which is necessary for the efficient application of grease to the sprocket tip.

TO LUBRICATE SPROCKET TIP:

Lubrication of the sprocket tip is recommended after 10 hours of use or once a week, whichever occurs first. Always thoroughly clean guide bar sprocket tip before lubrication.

NOTE: The saw chain does not have to be removed

GB

in order to lubricate the teeth of the chain bar. Lubrication is possible during work, with the engine switched off.

⚠WARNING: Wear heavy duty work gloves when handling the bar and chain.

1. Move the STOP switch down.
2. Clean the guide bar sprocket tip.
3. Using a Lube Gun, insert needle nose into the lubrication hole and inject grease until it appears at outside edge of sprocket tip (Fig. 23).
4. Rotate saw chain by hand. Repeat lubrication procedure until the entire sprocket tip has been greased.

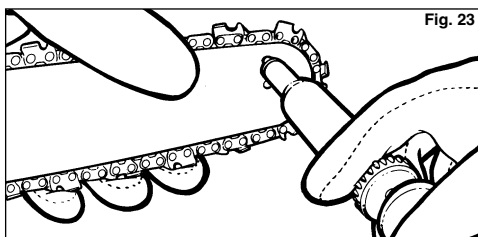

GUIDE BAR MAINTENANCE:

Most guide bar problems can be prevented merely by keeping the chain saw well maintained. Insufficient guide bar lubrication and operating the saw with chain that is TOO TIGHT will contribute to rapid bar wear.

To help minimize bar wear, the following guide bar maintenance procedures are recommended.

⚠WARNING: Always wear protective gloves during maintenance operations. Do not carry out maintenance when the engine is hot.

CHAIN SHARPENING:

Chain sharpening requires special tools to ensure that cutters are sharpened at the correct angle and depth. For the inexperienced chain saw user, we recommend that the saw chain be professionally sharpened by the nearest professional Service Center. If you feel comfortable sharpening your own saw chain, special tools are available from the professional Service Center.

CHAIN SHARPENING - The pitch of the chain (Fig. 24) is 3/8" LoPro x .050".

Sharpen the chain using protective gloves and a round file of $\varnothing 3/16"$ (4.8mm).

Always sharpen the cutters only with outward strokes (Fig. 25) observing the values given in Fig. 24. After sharpening, the cutting links must all have the same width and length.

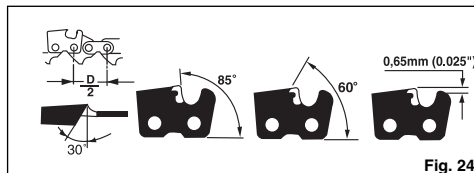

⚠WARNING: A sharp chain produces well-defined chips. When your chain starts to produce sawdust, it is time to sharpen.

After every 3-4 times the cutters have been sharpened you need to check the height of the depth gauges and, if necessary, lower them using the flat file and template supplied optional, then round off the front corner. (Fig. 26)

⚠WARNING: Proper adjustment of the depth gauge is as important as proper sharpening of the chain.

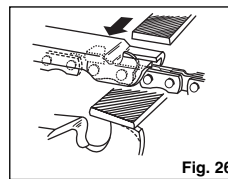
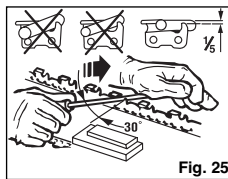

GUIDE BAR - The bar should be reversed every 8 working hours to ensure uniform wear.

Keep the bar groove and lubrication hole clean using a bar groove cleaner. (Fig. 27)

Check the bar rails frequently for wear and, if necessary, remove the burrs and square-up the rails using the flat file. (Fig. 28)

⚠WARNING: Never mount a new chain on a worn sprocket or self-aligning ring.

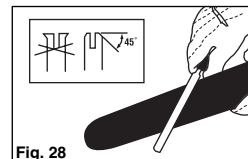
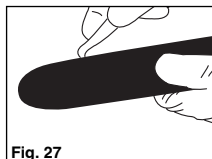

BAR WEAR - Turn guide bar frequently at regular intervals (for example, after 8 hours of use), to ensure even wear on top and bottom of bar.

OIL PASSAGES - Oil passages on the bar should be cleaned to ensure proper lubrication of the bar and chain during operation.

NOTE: The condition of the oil passages can be easily checked. If the passages are clear, the chain will automatically give off a spray of oil within seconds of starting the saw. Your saw is equipped with an automatic oiler system.

CHAIN MAINTENANCE

CHAIN TENSION:

Check the chain tension frequently and adjust as often as necessary to keep the chain snug on the bar, but loose enough to be pulled around by hand.

BREAKING IN A NEW SAW CHAIN:

A new chain and bar will need chain readjustment after as few as 5 cuts. This is normal during the break-in period, and the interval between future adjustments will begin to lengthen quickly.

⚠WARNING: Never have more than 3 links removed from a loop of chain. This could cause damage to the sprocket.

CHAIN LUBRICATION:

Always make sure the automatic oiler system is working properly. Keep the oil tank filled with Chain, Bar and Sprocket Oil.

Adequate lubrication of the bar and chain during cutting operations is essential to minimize friction with the guide bar.

Never starve the bar and chain of lubricating oil. Running the saw dry or with too little oil will decrease cutting efficiency, shorten saw chain life, cause rapid dulling of chain, and lead to excessive wear of bar from overheating. Too little oil is evidenced by smoke or bar discoloration.

ORDERING REPLACEMENT PARTS

Please quote the following data when ordering replacement parts:

- Type of machine
- Article number of the machine
- Identification number of the machine
- Replacement part number of the part required

Helpline Numbers:

UK: 0151 649 1500

IRE: 189 094 6244

GB**TROUBLESHOOTING THE ENGINE**

Problem	Probable Cause	Corrective Action
Unit won't start or starts but will not run.	Incorrect starting procedures.	Follow instructions in the User Manual.
	Incorrect carburetor mixture adjustment setting.	Have carburetor adjusted by an Authorized Service Center.
	Fouled spark plug	Clean / gap or replace plug.
	Fuel filter plugged.	Replace fuel filter.
Unit starts, but engine has low power.	Incorrect lever position on choke.	Move to RUN position.
	Dirty spark arrester screen	Replace spark arrester screen
	Dirty air filter.	Remove, clean and reinstall filter.
	Incorrect carburetor mixture adjustment setting.	Have carburetor adjusted by an Authorized Service Center.
	The distance between the motor and the ignition coil has changed	Arrange for an authorized Customer Service workshop to adjust the distance between the rotor and the ignition coil to 0.3-0.4 mm
Engine hesitates. No power under load.	Incorrect carburetor mixture adjustment setting.	Have carburetor adjusted by an Authorized Service Center.
Runs erratically.	Incorrectly gapped spark plug.	Clean / gap or replace plug.
Smokes excessively.	Incorrect carburetor mixture adjustment setting.	Have carburetor adjusted by an Authorized Service Center.
	Incorrect fuel mixture.	Use properly mixed fuel (40:1 mixture).
Chain does not move	chain brake activated	release chain brake
Poor cutting performance	blunt chain	sharpen chain
	chain incorrectly fitted	check chain fitment
	chain tension	check tension
Saw works only with difficulty, chain jumps off term	chain tension	check tension
Chain becomes hot	chain lubrication	check oil level check chain lubrication

Petrol Engine Starting Procedure / Check List

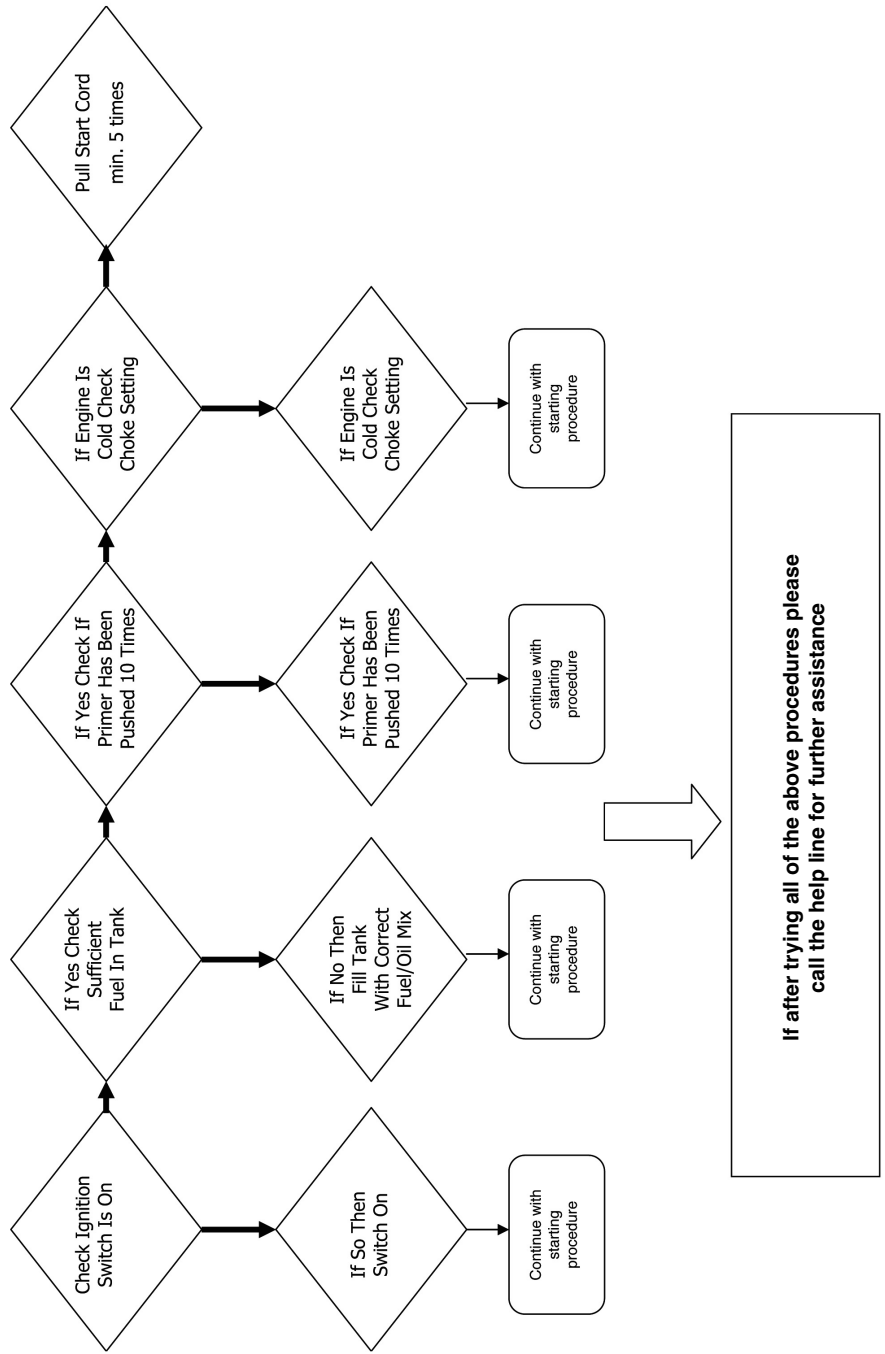

If after trying all of the above procedures please call the help line for further assistance

ISC GmbH
Eschenstraße 6
D-94405 Landau/Isar

Konformitätserklärung



- D** erklärt folgende Konformität gemäß EU-Richtlinie und Normen für Artikel
- GB** declares conformity with the EU Directive and standards marked below for the article
- F** déclare la conformité suivante selon la directive CE et les normes concernant l'article
- NL** verklaart de volgende conformiteit in overeenstemming met de EU-richtlijn en normen voor het artikel
- E** declara la siguiente conformidad a tenor de la directiva y normas de la UE para el artículo
- P** declara a seguinte conformidade de acordo com a directiva CE e normas para o artigo
- S** förklarar följande överensstämmelse enl. EU-direktiv och standarder för artikeln
- FIN** ilmoittaa seuraavaa Euroopan unionin direktiivien ja normien mukaista yhdenmukaisuutta tuotteelle
- N** erklærer herved følgende samsvar med EU-direktiv og standarder for artikkel
- HR** заявляє о соответствии товара следующим директивам и нормам EC
- HR** izjavljuje sljedeću uskladenost s odredbama i normama EU za artikl.
- RO** declară următoarea conformitate cu linia directoare CE și normele valabile pentru articolul.
- TR** ürün ile ilgili olarak AB Yönetmeliğeri ve Normları gereğince aşağıdaki uygunluk açıklama masını sunar.
- GR** δηλώνει την ακόλουθη συμφωνία σύμφωνα με την Οδηγία ΕΕ και τα πρότυπα για το προϊόν

- I** dichiara la seguente conformità secondo la direttiva UE e le norme per l'articolo
- DK** attesterer følgende overensstemmelse i henhold til EU-direktiv og standarder for produkt
- CZ** prohlašuje následující shodu podle směrnic EU a norem pro výrobek.
- H** a következő konformitást jelenti ki a termékkel vonatkozó EU-irányvonalak és normák szerint
- SK** pojednává sledečo skladnost po smernici EU in normah za artikel.
- PL** deklaruje zgodność wymienionego poniżej artykułu z następującymi normami na podstawie dyrektywy WE.
- SK** vydáva nasledujúce prehlásenie o zhode podľa smernice EÚ a noriem pre výrobok.
- BG** декларира следното съответствие съгласно директивите и нормите на ЕС за продукта.
- UKR** заявляє про відповідність згідно з Директивою ЄС та стандартами, чинними для даного товару
- EE** deklareerib vastavuse järgnevatele EL direktiivi dele ja normidele
- LT** deklaruoja atitiktį pagal ES direktyvas ir normas
- ES** straiipsnii
- ES** izjavljuje sledeći konformitet u skladu s odredbom EZ i normama za artikl
- LV** Atbilstības sertifikāts apliecina zemāk minēto preču atbilstību ES direktīvām un standartiem
- IS** Samræmisýfirlýsing staðfestir eftirfarandi samræmi samkvæmt reglum Evrópubandalagsins og stöðlum fyrir vörur

Petrol chain saw SPJCS 38

- | | |
|--|--|
| <input checked="" type="checkbox"/> 98/37/EG | <input type="checkbox"/> 87/404/EWG |
| <input type="checkbox"/> 73/23/EWG_93/68/EEC | <input type="checkbox"/> R&TTED 1999/5/EG |
| <input type="checkbox"/> 97/23/EG | <input checked="" type="checkbox"/> 2000/14/EG: LWM = 111 dB; LWA = 113 dB
P = 1,4 kW |
| <input checked="" type="checkbox"/> 89/336/EWG_93/68/EEC | <input type="checkbox"/> 95/54/EG: |
| <input type="checkbox"/> 90/396/EWG | <input checked="" type="checkbox"/> 97/68/EG: e4*97/68SH2G3*2002/88*0107*05 |
| <input type="checkbox"/> 89/686/EWG | |

EN ISO 11681-1; EN ISO 14982; KBV V
TÜV Product Service GmbH; Ridlerstraße 31, 80339 München
M6 06 10 24192 272

Landau/Isar, den 21.09.2006

Weichselgartner
General-Manager

Wimmer
Product-Management

Art.-Nr.: 45.014.34 I.-Nr.: 01016
Subject to change without notice

Archivierung: 4501430-08-4160270

GUARANTEE CERTIFICATE

Dear Customer,

All of our products undergo strict quality checks to ensure that they reach you in perfect condition. In the unlikely event that your device develops a fault, please contact our service department at the address shown on this guarantee card. Of course, if you would prefer to call us then we are also happy to offer our assistance under the service number printed below. Please note the following terms under which guarantee claims can be made:

1. These guarantee terms cover additional guarantee rights and do not affect your statutory warranty rights. We do not charge you for this guarantee.
2. Our guarantee only covers problems caused by material or manufacturing defects, and it is restricted to the rectification of these defects or replacement of the device. Please note that our devices have not been designed for use in commercial, trade or industrial applications. Consequently, the guarantee is invalidated if the equipment is used in commercial, trade or industrial applications or for other equivalent activities. The following are also excluded from our guarantee: compensation for transport damage, damage caused by failure to comply with the installation/assembly instructions or damage caused by unprofessional installation, failure to comply with the operating instructions (e.g. connection to the wrong mains voltage or current type), misuse or inappropriate use (such as overloading of the device or use of non-approved tools or accessories), failure to comply with the maintenance and safety regulations, ingress of foreign bodies into the device (e.g. sand, stones or dust), effects of force or external influences (e.g. damage caused by the device being dropped) and normal wear resulting from proper operation of the device.

The guarantee is rendered null and void if any attempt is made to tamper with the device.

3. The guarantee is valid for a period of 2 years starting from the purchase date of the device. Guarantee claims should be submitted before the end of the guarantee period within two weeks of the defect being noticed. No guarantee claims will be accepted after the end of the guarantee period. The original guarantee period remains applicable to the device even if repairs are carried out or parts are replaced. In such cases, the work performed or parts fitted will not result in an extension of the guarantee period, and no new guarantee will become active for the work performed or parts fitted. This also applies when an on-site service is used.

Of course, we are also happy offer a chargeable repair service for any defects which are not covered by the scope of this guarantee or for units which are no longer covered. To take advantage of this service, please send the device to our service address.

Argos Ltd
489-499 Avebury Boulevard
Saxon Gate West
Central Milton Keynes
MK9 2NW

Helpline Numbers:

UK: 0151 649 1500

IRE: 189 094 6244

© Technical specifications subject to change

19

Helpline No: UK 0151 649 1500 / IRE 189 094 6244

©

The reprinting or reproduction by any other means, in whole or in part, of documentation and papers accompanying products is permitted only with the express consent of ISC GmbH.

Einhell UK Ltd
Unit 5 Morpeth Wharf
Twelve Quays
Birkenhead, Wirral
CH41 1LF
Tel. 0151 6491500, Fax 0151 6491501

EH 10/2006

Helpline No: UK 0151 649 1500 / IRE 189 094 6244