



18V BRUSHLESS

# PRUNING CHAINSAW

## INSTRUCTION MANUAL

### SPECIFICATIONS

Input:	18V
Bar Length:	160mm
Cutting Length:	125mm max.
Chain Speed:	4.8m/s max.
Chain Pitch:	7.62mm
Chain Gauge:	1.0mm (0.039")
Oil Bottle:	50ml
Weight:	1.1kg

[ozito.com.au](http://ozito.com.au)

**5 YEAR**  
REPLACEMENT WARRANTY

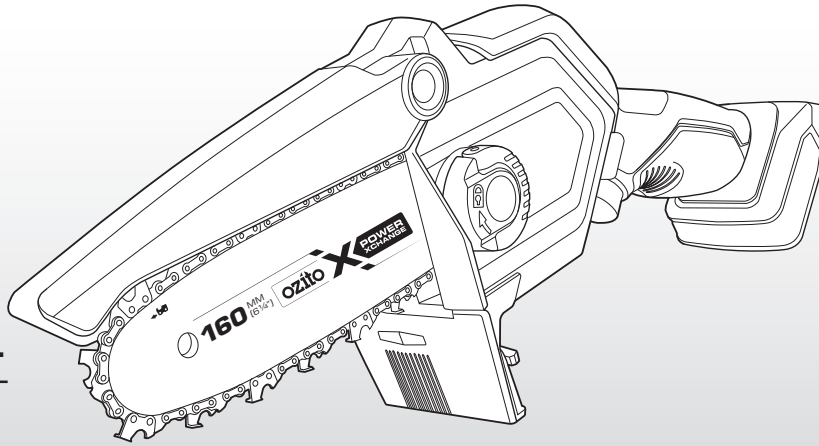

**This product is intended for use by a competent trained person. This user manual is a guide only and should not be treated as a training manual.**

- Please seek professional training before use.
- This product is designed for light limbing of branches and or light pruning of trees, shrubs and bushes while user is firmly footed on the ground. Not designed for tree-felling purposes.

### STANDARD EQUIPMENT



Pruning Chainsaw



Guide Bar & Chain

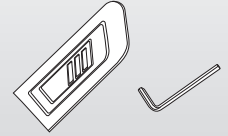

Bar & Chain Cover, Hex Key



Bottle for Oil

**PXBPCS-1815**

## WARRANTY

IN ORDER TO MAKE A CLAIM UNDER THIS WARRANTY YOU MUST RETURN THE PRODUCT TO YOUR NEAREST BUNNINGS WAREHOUSE WITH YOUR BUNNINGS REGISTER RECEIPT. PRIOR TO RETURNING YOUR PRODUCT FOR WARRANTY PLEASE TELEPHONE OUR CUSTOMER SERVICE HELPLINE:

**Australia 1800 069 486**  
**New Zealand 0508 069 486**

TO ENSURE A SPEEDY RESPONSE PLEASE HAVE THE MODEL NUMBER AND DATE OF PURCHASE AVAILABLE. A CUSTOMER SERVICE REPRESENTATIVE WILL TAKE YOUR CALL AND ANSWER ANY QUESTIONS YOU MAY HAVE RELATING TO THE WARRANTY POLICY OR PROCEDURE.

### WARNING

**The following actions will result in the warranty being void.**

- If the tool has been operated on a supply voltage other than that specified on the tool.
- If the tool shows signs of damage or defects caused by or resulting from abuse, accidents or alterations.
- Failure to perform maintenance as set out within the instruction manual.
- If the tool is disassembled or tampered with in any way.
- Professional, industrial or high frequency use.

The benefits provided under this warranty are in addition to other rights and remedies which are available to you at law.

Our goods come with guarantees that cannot be excluded at law. You are entitled to a replacement or refund for a major failure and for compensation for any other reasonably foreseeable loss or damage. You are also entitled to have the goods repaired or replaced if the goods fail to be of acceptable quality and the failure does not amount to a major failure.

Generally you will be responsible for all costs associated with a claim under this warranty, however, where you have suffered any additional direct loss as a result of a defective product you may be able to claim such expenses by contacting our customer service helpline above.

### 5 YEAR REPLACEMENT WARRANTY

Your Product is guaranteed for a period of 60 months from the original date of purchase and is intended for DIY (Do It Yourself) use only. If a product is defective it will be replaced in accordance with the terms of this warranty. **Lithium Ion batteries and chargers are covered by a 36 month warranty** Warranty excludes consumable parts, for example: guide bar, chain and included accessories.

# KNOW YOUR PRODUCT

## PRUNING CHAINSAW

- |                     |                       |
|---------------------|-----------------------|
| 1. Pivoting Guard   | 9. Hex Key Storage    |
| 2. Side Cover Lock  | 10. Safety Switch     |
| 3. Front Handle     | 11. On/Off Trigger    |
| 4. Side Cover       | 12. Battery Seating   |
| 5. Rear Handle      | 13. Chain & Bar Cover |
| 6. Chain            | 14. Hex Key           |
| 7. Guide Bar        | 15. Bottle for Oil    |
| 8. Front Hand Guard |                       |

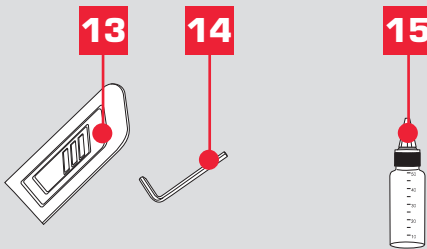
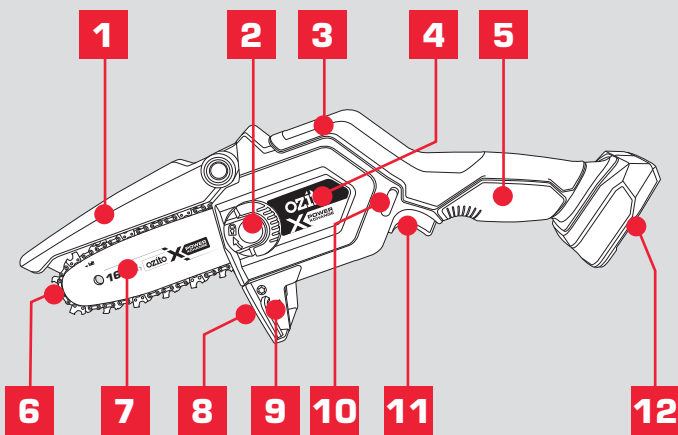

## BATTERY & CHARGER

This tool is compatible with all battery and chargers from the Ozito PXC Range.

### ONLINE MANUAL

Scan this QR Code with your mobile device to take you to the online manual.



**5 YEAR**  
REPLACEMENT WARRANTY

# SETUP & PREPARATION

## 1. ASSEMBLY

### Fitting the Chain & Bar

**WARNING!** ENSURE THE CHAINSAW IS SWITCHED OFF AND THE BATTERY IS DISCONNECTED BEFORE PERFORMING ANY OF THE FOLLOWING TASKS.

**WARNING!** ALWAYS WEAR GLOVES WHEN HANDLING THE CHAIN. THE CHAIN CUTTERS ARE SHARP AND COULD CUT YOU.

- Lift the tab on the Side Cover Lock and completely unscrew, rotating counter clockwise.
- Remove the Side Cover.

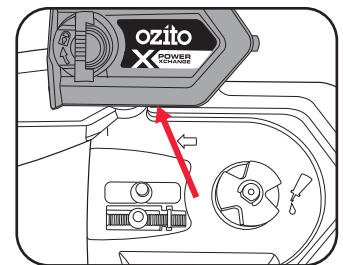
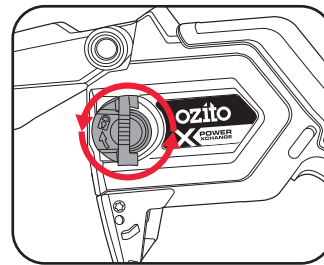

- Fit the Chain in the groove on the Guide Bar, making sure that the cutters are facing in the direction of rotation.

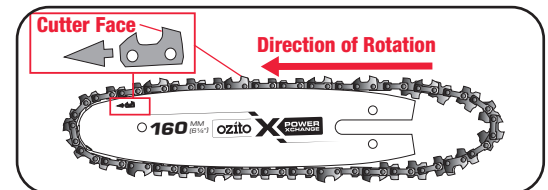

**IMPORTANT!** IF THE CHAIN IS INSTALLED BACKWARDS (CHAIN CUTTERS ARE FACING IN THE OPPOSITE DIRECTION OF ROTATION) THE CHAINSAW WILL VIBRATE EXCESSIVELY AND NOT CUT.

- Place the Guide Bar and Chain in position, ensuring that the chain is around sprocket **(A)** and the chain links are in the groove of the Guide Bar and the Sprocket. Also ensure that the pin **(B)** fits into the hole of the Guide Bar.

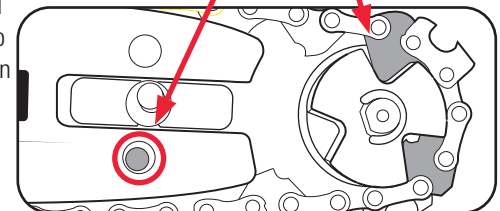
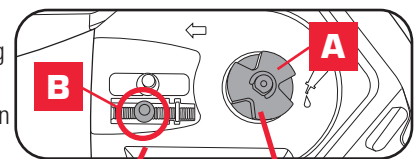

- Attach the Side Cover and secure it with the Side Cover Lock. Do not fully tighten until after adjusting the chain tension. **(See Adjusting the Chain Tension).**

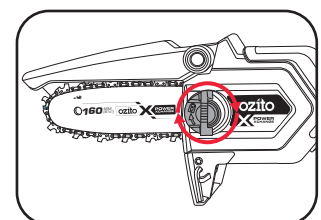

## 2. CHAIN TENSION & LUBRICATION

### Adjusting the Chain Tension

**WARNING!** THE CHAIN HAS SHARP EDGES, PLEASE USE WORK GLOVES. NEVER TOUCH THE CHAIN OR SERVICE THE UNIT WITH THE BATTERY FITTED.

1. Loosen the Side Cover Lock, rotating in a counter clockwise direction. Do not remove the Side Cover.

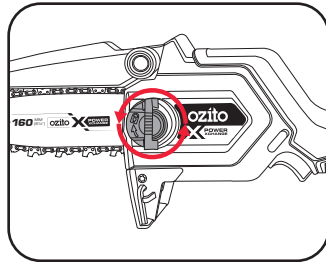

**WARNING!** IF YOU TRY TO ADJUST THE CHAIN TENSION WHILST THE SIDE COVER LOCK IS TIGHT, IT WILL RESULT IN THE CHAIN NOT LOOSENING AND POSSIBLE DAMAGE TO THE MECHANISM.

2. Adjust the chain tension by turning the chain tensioning screw with the supplied Hex Key. Turning the screw CLOCKWISE (as shown) increases the chain tension, turning it COUNTER-CLOCKWISE decreases the chain tension.

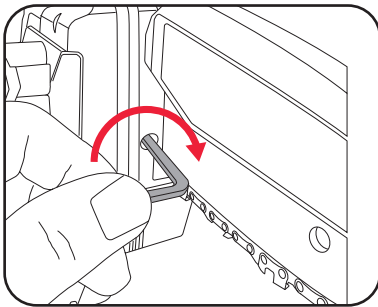

For the correct chain tension, firmly pull the chain away from the exposed guide bar. When the chain is pulled away at its furthest point, the bottom tip of the links should only just stay in the groove [middle of the guide bar].

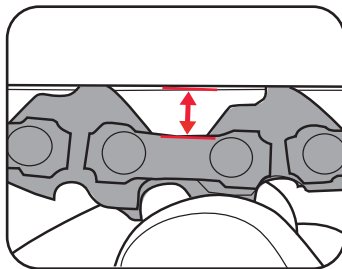
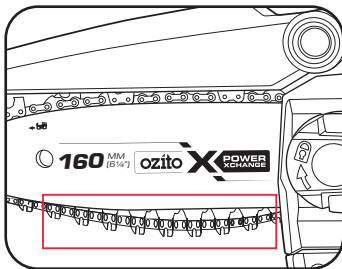

3. After the chain has been accurately tensioned, lock the guide bar in place with the Side Cover Lock.

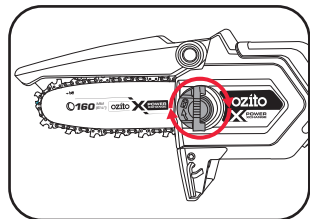

**Note:** Proper tension of the chain is extremely important and must be checked before starting, as well as during any cutting operation as the chain heats up thus changes in length. Taking the time to make adjustments to the chain will result in improved cutting performance and prolonged chain life.

Check the chain tension every 10 minutes and adjust it again as required.

### Chain & Guide Bar Lubrication

**WARNING!** NEVER START WORK UNLESS THE CHAIN AND GUIDE BAR ARE LUBRICATED.

**WARNING!** ONLY USE OIL THAT IS EXPRESSLY LABELLED 'CHAIN BAR OIL'.

1. Before starting operation, apply 5 drops of chain bar oil (not supplied) to the groove in the Guide Bar.

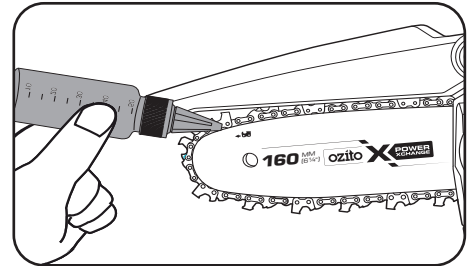

2. Repeat the lubrication process after 5 minutes of use (depending on the number and size of cuts) so that the chain does not run dry.

### Chain & Bar Cover

This protects the guide bar and chain when not in use. Simply slide it off before use. Once finished operating, place the cover back over the guide bar.

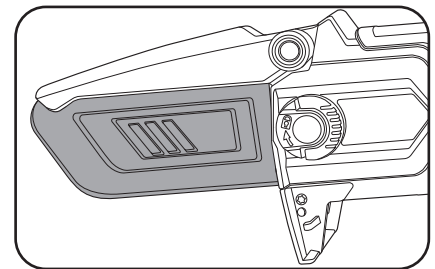

**WARNING!** NEVER START THE PRUNING CHAINSAW WHILE THE CHAIN & BAR COVER IS FITTED.

# OPERATION

## 3. BATTERY AND RUN TIME

### Inserting & Removing the Battery

Align the ribs of the battery with the recess below the handle and slide the battery in so that it clicks into place.

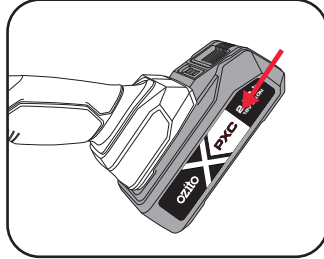

To remove, press and hold the battery release tab **(a)** to release, then slide the battery out **(b)**.

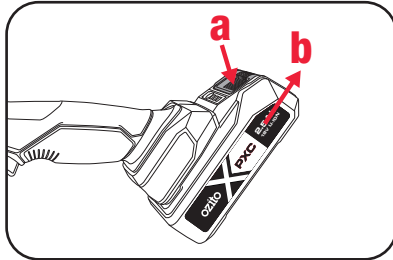

### Run Time

The operating time of the PXC battery (the amount that can be cut with a single battery charge) is largely dependent on the type of the timber (e.g. hardness, moisture, thickness, etc.) the sharpness of the chain and your rate of work.

Frequently turning the equipment on and off will also reduce the runtime and amount that you can cut. If the operating time of the PXC battery (runtime) is still unsatisfactory in spite of the above measures, you can remedy the problem by using a PXC battery with a larger capacity (Ah).

**WARNING!** DO NOT OPERATE THIS CHAINSAW WITH LONG LOOSE HAIR OR LOOSE FITTING JEWELLERY. TIE LONG LOOSE HAIR BACK AND REMOVE LOOSE FITTING JEWELLERY.

## 4. SWITCHING ON & OFF

**WARNING!** ALWAYS WEAR APPROPRIATE PERSONAL PROTECTIVE EQUIPMENT (PPE) WHEN USING THE CHAINSAW, SUCH AS STURDY SAFETY CHAPS, NON-SLIP FOOTWEAR, LONG TROUSERS, LEATHER GLOVES, SAFETY GLASSES, HEAD AND EAR PROTECTION. NEVER USE THE EQUIPMENT BAREFOOT OR IN SANDALS.

### Switching ON

1. Hold the Front Handle with your left hand and the Rear Handle with your right hand.

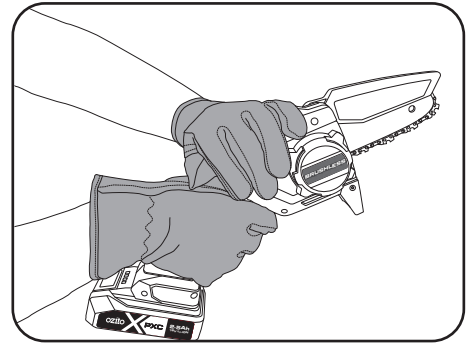

2. Press and hold the Safety Switch **(a)** with your thumb or finger, then squeeze the On/Off Trigger **(b)**. The pruning chainsaw starts after a short delay.

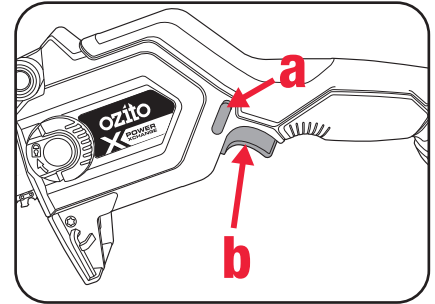

3. The chain will now be running, ready to make a cut. Release the Safety Switch **(a)**.

### Switching OFF

Release the On/Off Trigger, the chain and motor will quickly stop.

**Note:** The motor brakes the saw chain as soon as the On/Off Trigger is released.

**WARNING!** ALWAYS DISCONNECTED THE BATTERY WHEN YOU STOP WORKING OR MOVING FROM ONE AREA TO ANOTHER, EVEN IF IT IS ONLY FOR A SHORT PERIOD OF TIME.

### Running in the Chain

Prior to operation, a new chain should be run in for 2–3 minutes and then its tension should be checked and adjusted as detailed in 'Adjusting the Chain Tension.'

**IMPORTANT:** IT IS VITAL FOR THE PROPER AND SAFE OPERATION OF THE CHAINSAW THAT THE CHAIN IS TENSIONED CORRECTLY.

## 5. APPLICATIONS

**WARNING!** THIS PRODUCT IS INTENDED FOR USE BY A COMPETENT TRAINED PERSON. THIS USER MANUAL IS A GUIDE ONLY AND SHOULD NOT BE TREATED AS A TRAINING MANUAL. PLEASE SEEK PROFESSIONAL TRAINING BEFORE USE.

**WARNING!** DO NOT OPERATE THIS PRUNING CHAINSAW IN A TREE, ON A LADDER, FROM A ROOFTOP, EWP (ELEVATED WORK PLATFORM) OR UNSTABLE SUPPORT. THIS IS EXTREMELY DANGEROUS.

**WARNING!** ALWAYS USE THIS PRUNING CHAINSAW WITH BOTH HANDS. NEVER HOLD LIMBS WITH ONE HAND AND OPERATE THE PRUNING CHAINSAW WITH THE OTHER. FAILURE TO HEED THIS WARNING MAY RESULT IN SERIOUS INJURY.

### Limbing

**WARNING!** DO NOT STAND ON THE LOG. BE ALERT TO THE FACT THAT THE LOG MAY ROLL OVER. WHEN WORKING ON A SLOPE, ALWAYS STAND ON THE UP HILL SIDE OF THE LOG.

Limbing is the process of removing the branches from a fallen tree. Check the direction in which a branch will bend before cutting it. Always cut on the opposite side to the bending direction so that the guide bar is not pinched in the cut. For large limbs that cannot be removed in one cut, make an initial cut from the bent side and finish by sawing from the opposite direction. Do not remove limbs that are supporting the fallen tree on the ground until the tree has been cut into lengths.

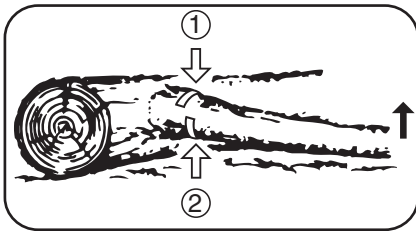

### Bucking

Bucking is cutting a log into lengths for easier handling. To saw a log lying on the ground, first saw halfway, then roll the log over and cut from the opposite side. To saw the end of a log supported off the ground, first saw up from the bottom one-third through the log then finish by sawing down from the top. To saw a log in the middle of two supports holding it off the ground, first saw down from the top one-third through the log then finish by sawing up from the bottom.

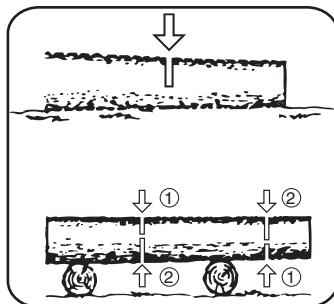

**CAUTION:** FIRST AVOID CUTTING THE GROUND AS THIS WILL VERY QUICKLY DULL THE CHAIN.

### Pruning

**WARNING!** DO NOT USE AN UNSTABLE FOOTHOLD OR LADDER. DO NOT OVERREACH. DO NOT SAW ABOVE SHOULDER HEIGHT. ALWAYS USE BOTH HANDS TO HOLD THE CHAINSAW. FIRST CUT UP FROM THE BOTTOM AND FINISH DOWN FROM THE TOP.

Pruning is the removal of a limb or branch from a standing tree.

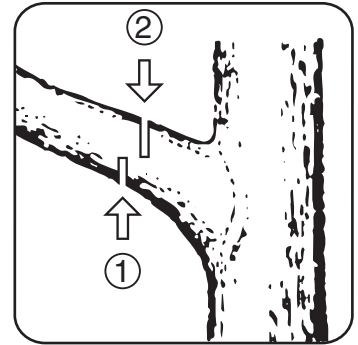

### Hints and Tips

- Do not force the saw into the cut. Apply only light pressure whilst running the chain.
- If the saw chain gets caught in the cut, do not try to remove it by twisting the guide bar or pulling forcibly. Use a lever or wedge to open up the cut so that the saw chain is freed.
- Keep your left arm with elbow locked in a "straight arm" position to withstand any kickback force.
- Before cutting ensure the chain is not making contact with the material being cut.
- While cutting, always:
  - Run the pruning chainsaw motor at full speed. This makes the job safer, as there is less chance of pull-in or kickback.
  - Position your body to the left of the chainsaw so if it kicks back uncontrollably, it goes over your right shoulder, never stand in the cutting line of the saw.
  - Keep a firm grip with your left hand on the front handle.

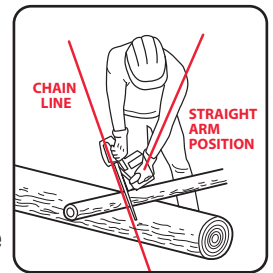

- This product **MUST NOT** be used for felling trees or used as a power tool to cut, shape or alter timber in a way for personal gain or preference.
- Two hands **MUST** be always used when in use.
- This Product **MUST NOT** be used if user is in a tree, hanging from branch/branches, off roof tops or buildings, ladder/s or EWP (Elevated Work Platform) of any kind.
- PPE (Goggles, Ear protection, Gloves, Coveralls, Chaps, etc..) **MUST** be always used when using this product.
- This Product **MUST NOT** be attached to any extension device or apparatus when in use. i.e. pole.
- This Product **MUST NOT** be attached to a rope or any hoisting device.



## OPERATION cont.

### 6. KICKBACK

The term 'kickback' describes what happens when the running chain catches on the wood being cut and the pruning chainsaw recoils back suddenly. Usually, this is caused by contact between the tip of the guide bar and the workpiece or the saw chain becoming trapped.

In the event of kickback, large forces occur suddenly and violently. As a result, the pruning chainsaw usually reacts uncontrollably. This can often result in very serious injuries to the worker or persons in the vicinity. The risk of kickback is particularly great when performing cross cuts, angled cuts and longitudinal cuts. You should therefore avoid these cuts as far as possible and take particular care when they are unavoidable.

If you place the tip of the guide bar in cutting position, the leverage effect and therefore the risk of kickback will be at its greatest. It is safest therefore to always position the saw as flat as possible.

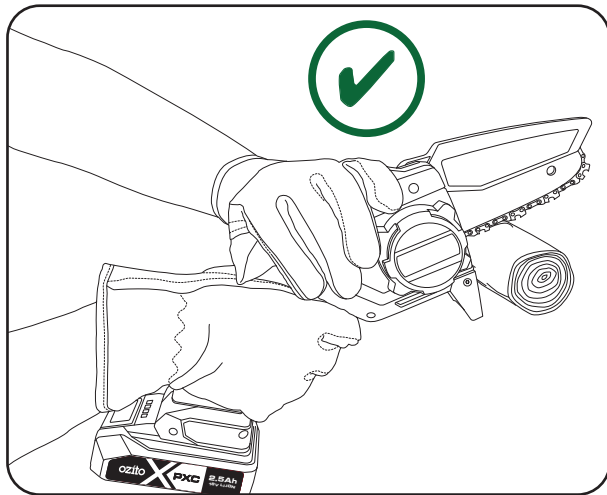

## MAINTENANCE

**WARNING!** BEFORE CLEANING YOUR PRUNING CHAINSAW OR CARRYING OUT ANY MAINTENANCE PROCEDURE, MAKE SURE THE BATTERY IS REMOVED TO PREVENT ACCIDENTAL STARTING.

**WARNING!** ALWAYS WEAR GLOVES WHEN HANDLING THE CHAIN. THE CHAIN CUTTERS ARE SHARP AND COULD CUT YOU.

### Chain Sharpening

Do not attempt to sharpen the chain yourself unless you have the necessary special tools and experience.

Chain File: 3.5mm (0.13")

Chain Pitch: 7.62mm

Chain Gauge: 1.0mm (0.039")

Sharpen the chain regularly to maintain optimum performance of the saw. Signs of a dull chain are:

- The sawdust becomes powder-like
- Extra force is required to execute a cut
- The cut does not track in a straight line
- Increased vibration

Sharpen each cutter using a round 3.5mm (0.13") chain file. Keep the file level with the top plate of the tooth. Always use outward strokes and maintain a 30° angle between the chain and file. After sharpening, the cutters must all have the same width and length.

After every 3–4 uses get an authorised repair centre to professionally sharpen your chain. They have the special tools necessary to ensure the correct cutting angles and depths.

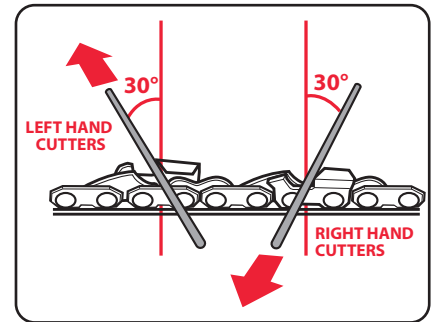

### Cleaning and Storing

- Keep the handles free of grease so that you can maintain a firm grip.
- Keep air intake clean and air vents free of debris to avoid overheating the motor.
- After each use, blow it with compressed air at low pressure through the motor housing to ensure it is free from all dust particles which may build up. Build up of dust particles may cause the unit to overheat and shorten the life of the pruning chainsaw.
- If the pruning chainsaw is not to be used for an extended period of time Briefly immerse the chain and the guide bar in an oil bath and then wrap them in oil paper.
- Ensure that the chain & bar cover is in place when storing.
- If the enclosure of the pruning chainsaw requires cleaning do not use solvents but a moist soft cloth or soft brush only. Never let any liquid get inside the chainsaw; never immerse any part of the chainsaw into liquid.
- Replace worn or damaged parts for safety
- Remove the battery from the pruning chainsaw when in storage.
- Store the equipment and its accessories in a dark and dry place at above freezing temperature. The ideal storage temperature is between 5°C and 30°C.

**WARNING!** NEVER IMMERSE THE UNIT IN WATER OR OTHER LIQUIDS IN ORDER TO CLEAN IT.

**WARNING!** STORE THE PRUNING CHAINSAW IN A SAFE AND DRY PLACE OUT OF THE REACH OF CHILDREN.

**Note:** Ozito Industries will not be responsible for any damage or injuries caused by the repair of the Pruning Chainsaw by an unauthorised person or by mishandling of the Chainsaw. This machine is designed for DIY use - use in commercial or industrial environments will void the warranty.

# TROUBLESHOOTING

PROBLEM	CAUSE	REMEDY
Pruning Chainsaw will not work	Battery low in charge	Charge battery
	Battery not inserted properly	Insert battery packs correctly
Dry chain	No oil has been applied	Apply some oil
Chain or guide bar hot	No oil has been applied	Apply some oil
	Blunt chain	Sharpen or replace chain
Pruning Chainsaw will not cut	Blunt chain	Sharpen or replace chain
	Chain on backwards (chain teeth pointing in the wrong direction)	Remove chain and reinstall with the teeth facing in the correct direction
	Worn chain	Replace the chain
Pruning Chainsaw judders, vibrates or does not cut properly	Chain tension too loose	Adjust chain to correct tension
	Blunt chain	Sharpen or replace chain
	Worn chain	Replace the chain
	Chain on backwards (chain teeth pointing in the wrong direction)	Remove chain and reinstall with the teeth facing in the correct direction

## Sparking visible through the housing air vents

A small amount of sparking may be visible through the housing vents. This is normal and does not indicate a problem.

## Battery protection system

The tool/machine is equipped with the battery protection system, which helps to ensure a long service life.

The output power automatically cuts off during operation when the tool and/or battery are placed under the following situations:

- **When the tool/machine is overloaded:**  
If this occurs, release the trigger switch and remove causes of overload, then pull the switch trigger again to restart.
- **When the remaining battery capacity becomes low:**  
Recharge the battery pack.

**Note:** The battery protection system does not in any way damage the tool/machine.

# CARING FOR THE ENVIRONMENT



Power tools that are no longer usable should not be disposed of with household waste but in an environmentally friendly way. Please recycle where facilities exist. Check with your local council authority for recycling advice.



Recycling packaging reduces the need for landfill and raw materials. Reuse of recycled material decreases pollution in the environment. Please recycle packaging where facilities exist. Check with your local council authority for recycling advice.

# SPARE PARTS

## Chain Replacement:

The chain can be purchased through Ozito spare parts or from your local Bunnings Warehouse. The correct chain can be purchased by matching the pitch, gauge and number of links as shown below:

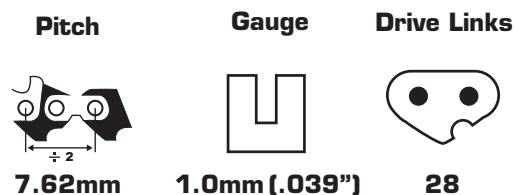

Spare parts can be ordered from the Special Orders Desk at your local Bunnings Warehouse.

For further information, or any parts not listed here, visit [www.ozito.com.au](http://www.ozito.com.au) or contact Ozito Customer Service:

Australia 1800 069 486

New Zealand 0508 069 486

E-mail: [hello@ozito.com.au](mailto:hello@ozito.com.au)

# DESCRIPTION OF SYMBOLS

<b>V</b>	Volts	<b>Hz</b>	Hertz
<b>~</b>	Alternating current	<b>W</b>	Watts
<b>dc/---</b>	Direct current	$\varnothing$	Diameter
<b>Ah</b>	Ampere hour	<b>n<sub>o</sub></b>	No load speed
<b>/min</b>	Revolutions or reciprocation per minute	<b>m/s</b>	Metres per second
<b>°C</b>	Degree Celsius	<b>mm</b>	Millimetre
	Warning!	<b>ml</b>	Millilitre
	Regulatory compliance mark (RCM)	<b>28</b>	Chain drive links 28
	Wear safety gloves		Wear ear & eye protection
	Do not saw in the rain or leave the pruning chainsaw outdoors while raining		
	Read instruction manual to reduce the risk of injury		
	Always hold the pruning chainsaw with both hands		
	<b>IMPORTANT!</b> When placing the chain on the guide bar, ensure the chain direction is the same as the image on the guide bar		
	Sound power level 87dB		Beware of chain saw kickback and avoid contact with guide bar tip



# ELECTRICAL SAFETY



**WARNING!** When using electric machines, basic safety precautions, including the following, should always be followed to reduce risk of fire, electric shock, personal injury and material damage.

- Read the whole manual carefully and make sure you know how to switch the machine off in an emergency, before operating the machine. Save these instructions and other documents supplied with this machine for future reference.
- This appliance is not intended for use by persons (including children) with reduced physical, sensory or mental capabilities, or lack of experience and knowledge, unless they have been given supervision or instruction concerning use of the appliance by a person responsible for their safety.

Children should be supervised to ensure that they do not play with the appliance.

- This appliance is compatible and only to be used with all batteries & chargers from the Ozito PXC range. Refer to the PXC battery and charger manuals for information regarding charging, use and storage.
- Remove the batteries from the appliance before being charged.
- Do not combine different types of batteries or new and used batteries.
- If the appliance is to be stored unused for a long period, the batteries should be removed.
- Do not use modified or damaged batteries.



# GENERAL MACHINE SAFETY WARNINGS



**WARNING!** Read all safety warnings, instructions, illustrations and specifications provided with this machine. Failure to follow all instructions listed below may result in electric shock, fire and/or serious injury.

Save all warnings and instructions for future reference.

The term "machine" in the warnings refers to your mains-operated (corded) machine or battery-operated (cordless) machine.

## 1) Work area safety

- Keep work area clean and well lit.** Cluttered or dark areas invite accidents.
- Do not operate machines in explosive atmospheres, such as in the presence of flammable liquids, gases or dust.** Machines create sparks which may ignite the dust or fumes.
- Keep children and bystanders away while operating a machine.** Distractions can cause you to lose control.

## 2) Electrical safety

- Machine plugs must match the outlet. Never modify the plug in any way. Do not use any adapter plugs with earthed (grounded) machines.** Unmodified plugs and matching outlets will reduce risk of electric shock.
- Avoid body contact with earthed or grounded surfaces, such as pipes, radiators, ranges and refrigerators.** There is an increased risk of electric shock if your body is earthed or grounded.
- Do not expose machines to rain or wet conditions.** Water entering a machine will increase the risk of electric shock.
- Do not abuse the cord. Never use the cord for carrying, pulling or unplugging the machine. Keep cord away from heat, oil, sharp edges or moving parts.** Damaged or entangled cords increase the risk of electric shock.
- When operating a machine outdoors, use an extension cord suitable for outdoor use.** Use of a cord suitable for outdoor use reduces the risk of electric shock.
- If operating a power tool in a damp location is unavoidable, use a residual current device (RCD) protected supply.** Use of an RCD reduces the risk of electric shock.

## 3) Personal safety

- Stay alert, watch what you are doing and use common sense when operating a machine. Do not use a machine while you are tired or under the influence of drugs, alcohol or medication.** A moment of inattention while operating machines may result in serious personal injury.
- Use personal protective equipment. Always wear eye protection.** Protective equipment such as a dust mask, non-skid safety shoes, hard hat or hearing protection used for appropriate conditions will reduce personal injuries.
- Prevent unintentional starting. Ensure the switch is in the off-position before connecting to power source and/or battery pack, picking up or carrying the machine.** Carrying machines with your finger on the switch or energising machines that have the switch on invites accidents.
- Remove any adjusting key or wrench before turning the machine on.** A wrench or a key left attached to a rotating part of the machine may result in personal injury.
- Do not overreach. Keep proper footing and balance at all times.** This enables better control of the machine in unexpected situations.
- Dress properly. Do not wear loose clothing or jewellery. Keep your hair and clothing away from moving parts.** Loose clothes, jewellery or long hair can be caught in moving parts.
- If devices are provided for the connection of dust extraction and collection facilities, ensure these are connected and properly used.** Use of dust collection can reduce dust-related hazards.
- Do not let familiarity gained from frequent use of machines allow you to become complacent and ignore machine safety principles.** A careless action can cause severe injury within a fraction of a second.

## 4) Machine use and care

- Do not force the machine. Use the correct machine for your application.** The correct machine will do the job better and safer at the rate for which it was designed.
- Do not use the machine if the switch does not turn it on and off.** Any machine that cannot be controlled with the switch is dangerous and must be repaired.
- Disconnect the plug from the power source and/or remove the battery pack, if detachable, from the machine before making any adjustments, changing accessories, or storing machines.** Such preventive safety measures reduce the risk of starting the machine accidentally.
- Store idle machines out of the reach of children and do not allow persons unfamiliar with the machine or these instructions to operate the machine.** Machines are dangerous in the hands of untrained users.
- Maintain machines and accessories. Check for misalignment or binding of moving parts, breakage of parts and any other condition that may affect the machine's operation. If damaged, have the machine repaired before use.** Many accidents are caused by poorly maintained machines.
- Keep cutting machines sharp and clean.** Properly maintained cutting machines with sharp cutting edges are less likely to bind and are easier to control.
- Use the machine, accessories and machine bits etc. in accordance with these instructions, taking into account the working conditions and the work to be performed.** Use of the machine for operations different from those intended could result in a hazardous situation.
- Keep handles and grasping surfaces dry, clean and free from oil and grease.** Slippery handles and grasping surfaces do not allow for safe handling and control of the machine in unexpected situations.

## 5) Battery machine use and care

- Recharge only with the charger specified by the manufacturer.** A charger that is suitable for one type of battery pack may create a risk of fire when used with another battery pack.
- Use machines only with specifically designated battery packs.** Use of any other battery packs may create a risk of injury and fire.
- When battery pack is not in use, keep it away from other metal objects, like paper clips, coins, keys, nails, screws or other small metal objects, that can make a connection from one terminal to another.** Shorting the battery terminals together may cause burns or a fire.
- Under abusive conditions, liquid may be ejected from the battery; avoid contact. If contact accidentally occurs, flush with water. If liquid contacts eyes, additionally seek medical help.** Liquid ejected from the battery may cause irritation or burns.
- Do not use a battery pack or machine that is damaged or modified.** Damaged or modified batteries may exhibit unpredictable behaviour resulting in fire, explosion or risk of injury.
- Do not expose a battery pack or machine to fire or excessive temperature.** Exposure to fire or temperature above 130 °C may cause explosion.
- Follow all charging instructions and do not charge the battery pack or machine outside the temperature range specified in the instructions.** Charging improperly or at temperatures outside the specified range may damage the battery and increase the risk of fire.

## 6) Service

- Have your machine serviced by a qualified repair person using only identical replacement parts.** This will ensure that the safety of the machine is maintained.
- Never service damaged battery packs.** Service of battery packs should only be performed by the manufacturer or authorized service providers.



# CHAINSAW SAFETY WARNINGS



**WARNING!** This appliance is not intended for use by persons (including children) with reduced physical, sensory or mental capabilities, or lack of experience and knowledge, unless they have been given supervision or instruction concerning use of the appliance by a person responsible for their safety.

Young children should be supervised to ensure that they do not play with the appliance.

## 1) General chain saw safety warnings:

- **Keep all parts of the body away from the saw chain when the chain saw is operating. Before you start the chain saw, make sure the saw chain is not contacting anything.** A moment of inattention while operating chain saws may cause entanglement of your clothing or body with the saw chain.
- **Always hold the chain saw with your right hand on the rear handle and your left hand on the front handle.** Holding the chain saw with a reversed hand configuration increases the risk of personal injury and should never be done.
- **Hold the chain saw by insulated gripping surfaces only, because the saw chain may contact hidden wiring or its own cord.** Saw chains contacting a "live" wire may make exposed metal parts of the chain saw "live" and could give the operator an electric shock.
- **Wear eye protection. Further protective equipment for hearing, head, hands, legs and feet is recommended.** Adequate protective equipment will reduce personal injury from flying debris or accidental contact with the saw chain.
- **Do not operate a chain saw in a tree, on a ladder, from a rooftop, or any unstable support.** Operation of a chain saw in this manner could result in serious personal injury.
- **Always keep proper footing and operate the chain saw only when standing on fixed, secure and level surface.** Slippery or unstable surfaces may cause a loss of balance or control of the chain saw.
- **When cutting a limb that is under tension, be alert for spring back.** When the tension in the wood fibres is released, the spring loaded limb may strike the operator and/or throw the chain saw out of control.
- **Use extreme caution when cutting brush and saplings.** The slender material may catch the saw chain and be whipped toward you or pull you off balance.
- **Carry the chain saw by the front handle with the chain saw switched off and away from your body. When transporting or storing the chain saw, always fit the guide bar cover.** Proper handling of the chain saw will reduce the likelihood of accidental contact with the moving saw chain.
- **Follow instructions for lubricating, chain tensioning and changing the bar and chain.** Improperly tensioned or lubricated chain may either break or increase the chance for kickback.
- **Cut wood only. Do not use chain saw for purposes not intended. For example: do not use chain saw for cutting metal, plastic, masonry or non-wood building materials.** Use of the chain saw for operations different than intended could result in a hazardous situation.

- **Do not attempt to fell a tree.** Serious injury could occur to the operator or bystanders while felling a tree.
- **This product is NOT a Toy.** Not for use from persons under 16yrs of age.

## 2) Causes and operator prevention of kickback:

Kickback may occur when the nose or tip of the guide bar touches an object, or when the wood closes in and pinches the saw chain in the cut.

Tip contact in some cases may cause a sudden reverse reaction, kicking the guide bar up and back towards the operator.

Pinching the saw chain along the top of the guide bar may push the guide bar rapidly back towards the operator.

Either of these reactions may cause you to lose control of the saw which could result in serious personal injury. Do not rely exclusively upon the safety devices built into your saw. As a chain saw user, you should take several steps to keep your cutting jobs free from accident or injury.

Kickback is the result of chain saw misuse and/or incorrect operating procedures or conditions and can be avoided by taking proper precautions as given below:

- **Maintain a firm grip, with thumbs and fingers encircling the chain saw handles, with both hands on the saw and position your body and arm to allow you to resist kickback forces.** Kickback forces can be controlled by the operator, if proper precautions are taken. Do not let go of the chain saw.
- **Do not overreach and do not cut above shoulder height.** This helps prevent unintended tip contact and enables better control of the chain saw in unexpected situations.
- **Only use replacement guide bars and saw chains specified by the manufacturer.** Incorrect replacement guide bars and saw chains may cause chain breakage and/or kickback.
- **Follow the manufacturer's sharpening and maintenance instructions for the saw chain.** Decreasing the depth gauge height can lead to increased kickback.



**WARNING!** When servicing, use only identical replacement parts. Use of any other parts may create a hazard or cause product damage. To ensure safety and reliability, all repairs should be performed by a qualified service technician.



**Danger!** Always remove the battery from the pruning chainsaw:

- when the equipment is left unattended,
- when the equipment is being checked, cleaned, or having maintenance work done,
- after striking a foreign object. Inspect the appliance for damage and make repairs as necessary.
- or if the equipment vibrates abnormally.