

Ⓜ Operating instructions for
Hedge Trimmer



GARDENLINE

CE

Art.-Nr.: 34.036.31

I.-Nr.: 01014

GLH 660



Read the complete operating manual with due care and keep it in a safe place. If you give the machine to any other person, hand over this operating manual as well!

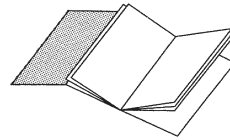

Ⓞ Please pull out page 2

1. General safety regulations
2. Layout
3. Explanation of the sign
4. Technical data
5. Mains connection
6. Start-up and operation
7. Notes on working practice
8. Maintenance, care and storage
9. Troubleshooting
10. Waste disposal
11. Replacement parts diagram
12. Replacement parts list

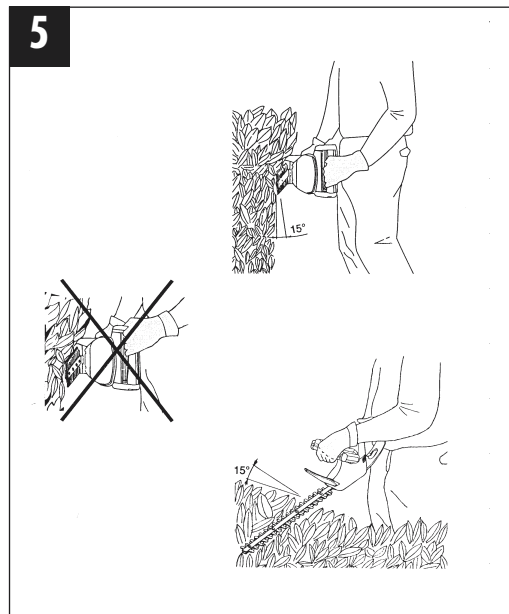
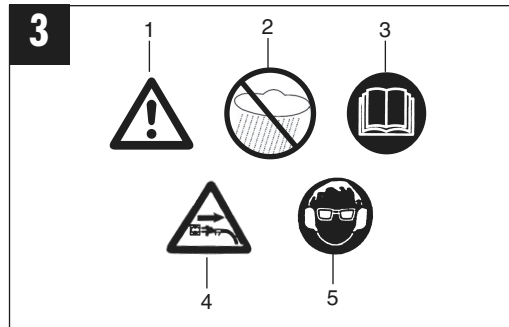
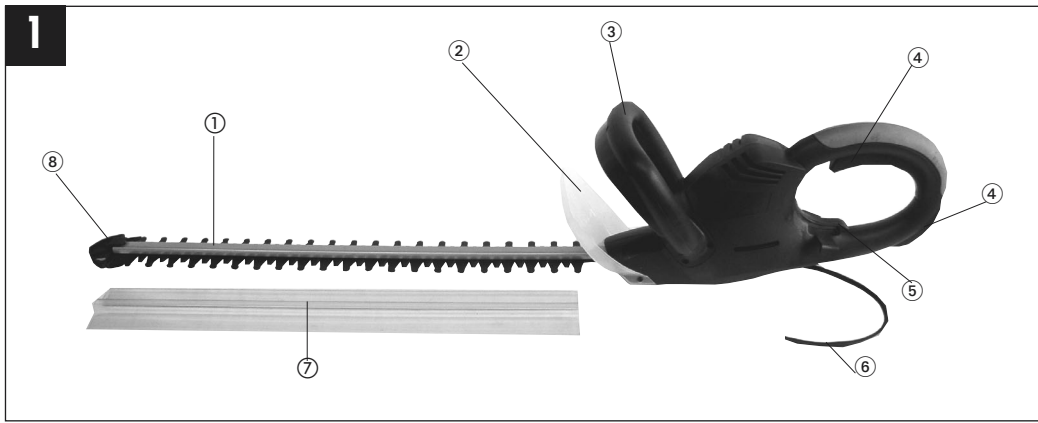

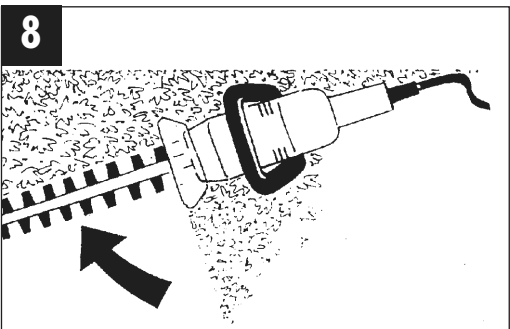
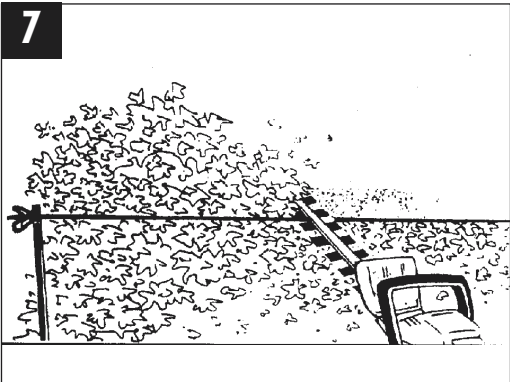
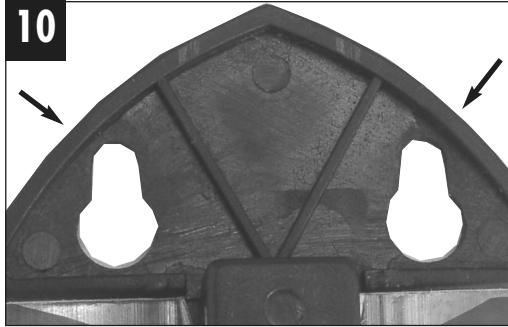
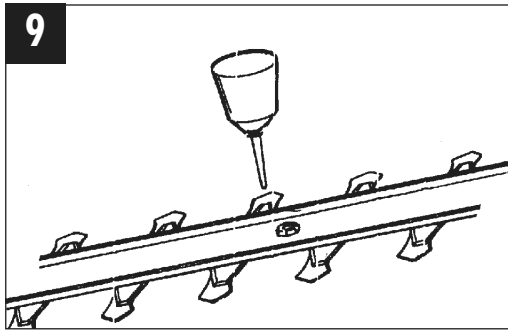

1. General safety information

Caution! When using electric tools it is imperative to take the following basic safety precautions in order to reduce the risk of electric shock, injury and fire. Read and take note of these instructions before you use this tool.

- 1. Keep your work area tidy**
- An untidy work area invites accidents.
- 2. Check the working conditions**
- Do not expose electric tools to rain. Never use electric tools in damp or wet locations. Make sure there is good lighting. Do not use electric tools near flammable liquids or gases.
- 3. Guard against electric shock**
- Avoid body contact with earthed components such as pipes, radiators, cookers, refrigerators.
- 4. Keep children away!**
- Do not allow other persons to touch the tool or cable. Keep all persons out of your work area.
- 5. Store tools in a safe place**
- When tools are not in use they should be stored in a dry, locked room out of children's reach.
- 6. Do not overload your tools**
- Tools work better and safer when used within their quoted capacity range.
- 7. Use the right tool**
- Never use tools or attachments with insufficient power for the job in hand. Never use tools on jobs for which they were not intended.
- 8. Wear suitable work clothes**
- Do not wear loose clothing or jewelry as they may get caught in moving parts. Rubber gloves and non-slip shoes are recommended when working outdoors. Wear a hair net if you have long hair.
- 9. Wear safety goggles**
- and use a dust mask when working on dusty jobs.
- 10. Do not mis-use the cable**
- Do not carry the tool by its cable or pull on the cable to remove the plug from the socket-outlet. Protect the cable from heat, oil and sharp edges.
- 11. Don't overreach**
- Avoid abnormal working postures. Make sure you stand squarely and keep your balance at all times.
- 12. Look after your tools**
- Keep your tools sharp and clean for better and safer performance. Follow the instructions for maintenance work and for changing any attachments. Check the plug and cable regularly and, if damaged, have them replaced by an authorized specialist. Check the extension cable regularly and replace it if damaged. Keep handles dry and free from oil and grease.
- 13. Always pull out the power plug**
- when the tool is not being used, before carrying out any maintenance work and when changing attachments such as blades, bits and cutters of any kind.
- 14. Remove adjusting keys and wrenches**
- Make sure that all keys and adjusting wrenches are removed from the tool before switching it on.
- 15. Avoid unintentional starting**
- Never carry a tool with your finger on the switch if it is connected to the power supply. Make sure that the switch is in OFF position when inserting the power plug.
- 16. When using an extension cable outdoors**
- check that it is approved for outdoor duty and is marked accordingly.
- 17. Be alert at all times**
- Watch what you are doing. Use common sense. Do not operate the tool if your mind is not on your work.
- 18. Check the tool for damage**
- Each time before re-using the tool, carefully check that the guards or any slightly damaged parts are working as intended. Check that the moving parts are in good working order, that they do not jam, and that no parts are damaged. Make sure that all parts are fitted correctly and that all other operating conditions are properly fulfilled. Unless otherwise stated in the operating instructions, damaged guards and parts have to be repaired or replaced by an authorized service center. It is imperative to have damaged switches repaired by an authorized service center. Never use any tool if its switch cannot be turned off and on.
- 19. Important!**
- For your own safety, use only accessories and attachments which are listed in the operating instructions or recommended or listed by the tool manufacturer. The use of any accessory or attachment other than those recommended in the operating instructions or catalogue may involve a risk of injury for you personally.
- 20. Have repairs carried out only by a qualified electrician**
- This electric tool complies with the pertinent safety regulations. Repairs are to be carried out only by a qualified electrician or the user may suffer an accident.

GB**21. Replacing the power cable**

To prevent injury, damaged power cables may only be replaced by the manufacturer or the customer service center.

22. Noise

- The noise level of this electric tool is measured in accordance with ISO 3744 and NFS 31-031 (84/537 EWG). Noise at the workplace may exceed 85 dB(A). In this case, the operator must wear ear-muffs or similar.

Keep these safety instructions in a safe place.

Specific safety information

Please read this safety information and the directions for use carefully and be sure to follow the instructions to the letter.

1. Always remove the power plug from the socket-outlet before you perform any work on the hedge trimmer, e.g.
 - repairing a damaged cable
 - cleaning the blades
 - troubleshooting
 - cleaning and maintenance
 or before leaving the tool unattended.
2. The hedge trimmer can cause serious injuries! Read the directions for use carefully in order to acquaint yourself with the correct way to handle, set up, service, start and put down the machine. Familiarize yourself with all the machine's control elements and its proper use.
3. Always handle the hedge trimmer with both hands.
4. When working with the hedge trimmer, wear sturdy shoes and make sure of your footing.
5. Never work with the hedge trimmer in the rain or on wet hedges and never leave the hedge trimmer outdoors. The hedge trimmer must not be used if it is wet.
6. We recommend that you wear safety goggles and ear-muffs when working with the hedge trimmer.
7. Wear suitable working clothes such as rubber gloves and non-slip shoes. Do not wear loose garments. Keep long hair in a hairnet.
8. Avoid abnormal postures and make sure of your footing, particularly when working on ladders and steps.
9. Be sure to hold the hedge trimmer well away from your body when it is switched on.
10. Make sure there are no other persons or animals within your working area (radius of swing).
11. Carry the hedge trimmer only by its guide handle.
12. Keep cables clear of the work area.
13. Before you use the hedge trimmer, examine the power cable for signs of damage and aging.
14. Use the hedge trimmer only when the power cable is in good working order.
15. Do not remove the power plug from the socket-outlet by pulling on the cable. Never carry the tool by its cable. Take care not to damage the cable in any way.
16. Protect cables from heat, caustic fluids and sharp edges. Replace damaged cables immediately.
17. Examine the cutting system regularly for signs of damage and, if necessary, arrange for the hedge trimmer to be professionally repaired.
18. If the blades become jammed, e.g. due to thick branches or the like, switch off and unplug the hedge trimmer immediately. Only then are you to remove the cause of the obstruction.
19. Keep the hedge trimmer in a dry place out of children's reach.
20. During transportation and storage of the hedge trimmer, keep the blades covered at all times with the special guard.
21. Take care not to overload the hedge trimmer and do not use it on jobs for which it is not intended, i.e. you are allowed to use the hedge trimmer only to cut hedges, shrubs and perennials.
22. Use only cables and connectors approved for outdoor use: power cable HO7RN-F 2x1.0 with integral two-plug plug; extension cable HO7RN-F 3G1.5 with rain-water-protected earthing-pin plug and earthing-contact coupling. The use of a leakage-current or earth-leakage circuit-breaker is recommended for operating electric tools. Ask your electrician!
23. The hedge trimmer requires regular inspection and maintenance. Always replace damaged blades in pairs. If the hedge trimmer suffers any damage from impact (falling on hard ground etc.), have it checked immediately by a specialist.
24. Look after your hedge trimmer carefully. Keep it clean and sharp to ensure efficient and safe cutting. Follow the maintenance and cleaning instructions.
25. Do not use the hedge trimmer with a damaged or excessively worn cutting system.
26. Never try to work with an incomplete machine or a machine with unapproved modifications.
27. Check your surroundings and take note of any potential dangers which you may not be able hear due to the machine's noise.

28. It is advisable not to use the hedge trimmer when other persons, and particularly children, are nearby.
29. Noise at the workplace may exceed 85 dB(A). In this case, the operator must wear ear-muffs or similar. The noise level of this electric tool is measured in accordance with IEC 59 CO 11; IEC 704; DIN 45635-1, D.3.1; and NFS 31-031 (84/537 EWG).
30. Vibrations on the handle were measured in accordance with EN 50144-2-15.
31. Please use an RCD with this unit.

2. Layout (see Fig. 1)

1. Cutter
2. Hand guard
3. Guide handle with switch button
4. Handle with switch buttons above and below
5. Stress relief clip
6. Power cable
7. Cutter guard
8. Impact guard

Important! You must never use the hedge trimmer without wearing gloves.

3. Explanation of the plate (see Fig. 3)

1. Warning
2. Keep out of the rain and protect from getting wet.
3. Read the operating instructions before using for the first time.
4. Pull the plug from the power supply immediately if the cable gets damaged or severed.
5. Wear goggles and ear protection.

4. Technical data

| | |
|--------------------------|----------------------|
| Voltage | 230V ~ 50Hz |
| Power consumption | 600 W |
| Cutting length | 590 mm |
| Cutter rail length | 660 mm |
| Tooth spacing | 20 mm |
| Cuts/min | 3200/min |
| Sound power level LWA | 96 dB(A) |
| Sound pressure level LPA | 88,6 dB(A) |
| Vibration aw | 3,3 m/s ² |
| Weight | 4,0 kg |

5. Voltage

The machine can only be run on single-phase alternating current with 230V ~ 50Hz a.c. voltage. Before you use the machine for the first time, check that the mains voltage is the same as the operating voltage shown on the machine rating plate.

6. Using for the first time and operation

Important! This hedge trimmer is designed for the trimming of hedges, bushes and shrubs. If it is used for any other purpose not expressly permitted by these operating instructions there may be a risk of damage to the hedge trimmer or serious injury to the user. The hedge trimmer comes with a two-hand safety switch. It only works if the switch on the guide handle (Fig. 2 / Item 1) is pressed with one hand and either the switch on top of the handle (Fig. 2 / Item 2) or the switch below the handle (Fig. 2 / Item 3) is pressed with the other hand. Releasing any of the switches will bring the hedge trimmer to a stop.

Please watch out for the cutters as they slow down to a standstill.

- Please check that the cutters work properly. The twin-bladed cutters rotate in opposite directions, thus guaranteeing high cutting performance and smooth operation.
- Before use, fasten the extension cable in the stress-relief clip (see Fig. 4).
- When working outdoors, use extension cables that are approved for the purpose.

7. Tips on use

- The hedge trimmer can be used not only for trimming hedges but for trimming shrubs and bushes as well.
- For optimum trimming performance, guide the blade teeth at an angle of approx. 15° to the hedge (see Fig. 5).
- Since the blades cut on both sides and run in opposite directions to each other, you can trim in both directions (see Fig. 6).
- To achieve a hedge with a uniform height it is recommended that you stretch a piece of string along the edge of the hedge for guidance. Then simply cut away all twigs projecting above the line (see Fig. 7).
- The sides of the hedge should be trimmed with

GB

arc-type movements from below upwards (see Fig. 8).

8. Care, maintenance and storage

- Always switch off the machine and pull the plug before you start to clean the machine.
- For optimum results at all times you should regularly clean and lubricate the blades. Remove any deposits with a brush and apply a light film of oil (see Fig. 9).

Use biologically degradable oil.

- Clean the plastic body with gentle domestic cleaning agent and a damp cloth. Never use aggressive media or solvents.
- It is imperative that you prevent water from penetrating the machine. Never spray the machine down with water.
- For storage purposes the hedge trimmer can be fastened to the wall with suitable screws and dowels (see Fig. 10).

9. Faults

- The machine does not start: Check that the power cable is correctly connected and check the mains fuses. If the machine still does not work even with connected voltage, please send it to the specified customer services address.

10. Disposal

Important!

The hedge trimmer and its accessories are made of a diversity of materials such as, e.g. metal and plastic.

Defective parts must be disposed of as special waste. Ask your specialist dealer or local authority for details about where they can be disposed of!

ISC GmbH
Eschenstraße 6
D-94405 Landau/Isar

Konformitätserklärung



- (D)** erklärt folgende Konformität gemäß EU-Richtlinie und Normen für Artikel
- (GB)** declares conformity with the EU Directive and standards marked below for the article
- (F)** déclare la conformité suivante selon la directive CE et les normes concernant l'article
- (NL)** verklaart de volgende conformiteit in overeenstemming met de EU-richtlijn en normen voor het artikel
- (E)** declara la siguiente conformidad a tenor de la directiva y normas de la UE para el artículo
- (P)** declara a seguinte conformidade de acordo com a directiva CE e normas para o artigo
- (S)** förklarar följande överensstämmelse enl. EU-direktiv och standarder för artikeln
- (FIN)** ilmoittaa seuraavaa Euroopan unionin direktiivien ja normien mukaista yhdenmukaista tuotteelle
- (N)** erklærer herved følgende samsvar med EU-direktiv og standarder for artikkel
- (RUS)** заявляет о соответствии товара следующим директивам и нормам ЕС
- (HR)** izjavljuje sljedeću uskladenost s odredbama i normama EU za artikl.
- (RO)** declară următoarea conformitate cu linia directoare CE și norme valabile pentru articolul.
- (TR)** ürün ile ilgili olarak AB Yönetmelikleri ve Normları gereğince aşağıdaki uygunluk açıklama masını sunar.
- (GR)** δηλώνει την ακόλουθη συμφωνία σύμφωνα με την Οδηγία ΕΕ και τα πρότυπα για το προϊόν
- (I)** dichiara la seguente conformità secondo la direttiva UE e le norme per l'articolo
- (DK)** attesterer følgende overensstemmelse i henhold til EU-direktiv og standarder for produkt
- (CZ)** prohlašuje následující shodu podle směrnic EU a norem pro výrobek.
- (H)** a következő konformitást jelenti ki a termékekre vonatkozó EU-irányvonalak és normák szerint
- (SLO)** pojasnjuje sledečo skladnost po smernici EU in normah za artikel.
- (PL)** deklaruje zgodność wymienionego poniżej artykułu z następującymi normami na podstawie dyrektywy WE.
- (SK)** vydáva nasledujúce prehlásenie o zhode podľa smernice EÚ a noriem pre výrobok.
- (BG)** декларира следното съответствие съгласно директивите и нормите на ЕС за продукта.

Hedge Trimmer GLH 660

- 98/37/EG 87/404/EWG
- 73/23/EWG_93/68/EEC R&TTED 1999/5/EG
- 97/23/EG 2000/14/EG: gemessener Schalleistungspegel L_{WA} = 93 dB
garantierter Schalleistungspegel L_{WA} = 96 dB
- 89/336/EWG_93/68/EEC 95/54/EG:
- 90/396/EWG 2002/88/EG:
- 89/686/EWG

EN 50144-1; EN 50144-2-15; DIN EN 774; EN 55014-1; EN 55014-2;
EN 61000-3-2; EN 61000-3-3; ISO 4871; KBV V

Landau/Isar, den 18.11.2004

Weichselgartner
Leiter QS Konzern

Ensing
Leiter Technik EC

Art.-Nr.: 34.036.31 I.-Nr.: 01014
Subject to change without notice

Archivierung: 3403630-05-4175500-E

GARANTIEURKUNDE

Auf das in der Anleitung bezeichnete Gerät geben wir 2 Jahre Garantie, für den Fall, dass unser Produkt mangelhaft sein sollte. Die 2-Jahres-Frist beginnt mit dem Gefahrenübergang oder der Übernahme des Gerätes durch den Kunden. Voraussetzung für die Geltendmachung der Garantie ist eine ordnungsgemäße Wartung entsprechend der Bedienungsanleitung sowie die bestimmungsgemäße Benutzung unseres Gerätes.

Selbstverständlich bleiben Ihnen die gesetzlichen Gewährleistungsrechte innerhalb dieser 2 Jahre erhalten. Die Garantie gilt für den Bereich der Bundesrepublik Deutschland oder der jeweiligen Länder des regionalen Hauptvertriebspartners als Ergänzung der lokal gültigen gesetzlichen Vorschriften. Bitte beachten Sie Ihren Ansprechpartner des regional zuständigen Kundendienstes oder die unten aufgeführte Serviceadresse.

Helpline-No.:

GB 0044 (0) 151 649 1500

IRL 189 09 46244

GB WARRANTY CERTIFICATE

The product described in these instructions comes with a 2 year warranty covering defects. This 2-year warranty period begins with the passing of risk or when the customer receives the product. Please retain receipt as proof of purchase.

For warranty claims to be accepted, the product has to receive the correct maintenance and be put to the proper use as described in the operating instructions.

Your statutory rights of warranty are naturally unaffected during these 2 years.

This warranty applies in Germany, or in the respective country of the manufacturer's main regional sales partner, as a supplement to local regulations. Please note the details for contacting the customer service center responsible for your region or the service address listed below.

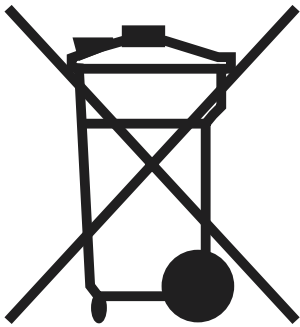

GB For EU countries only

Never place any electric tools in your household refuse.

To comply with European Directive 2002/96/EC concerning old electric and electronic equipment and its implementation in national laws, old electric tools have to be separated from other waste and disposed of in an environment-friendly fashion, e.g. by taking to a recycling depot.

GB

The reprinting or reproduction by any other means, in whole or in part, of documentation and papers accompanying products is permitted only with the express consent of ISC GmbH.

© Technical specifications subject to change

EH 12/2004