

GARDENLINE®

Electric Hedge Trimmer

User Guide

After Sales Support

Now you have purchased a Gardenline® product you can rest assured in the knowledge that as well as your 1 year parts and labour guarantee you have the added peace of mind of dedicated helplines and web support.



AFTER SALES SUPPORT



1300 922 271



service.australia@einhell.com

BG-EH 3551T, 04/11

Contents

03	General Information and Safety Instructions
03	Layout
03	Proper Use
08	Technical Data
08	Before starting the equipment
08	Operation
09	Replacing the power cable
09	Cleaning, maintenance and ordering of spare parts
09	Disposal and recycling
10	Faults

What your 1 year warranty means

Congratulations on choosing to buy a Gardenline® product. By doing so you now have the assurance and peace of mind that comes with purchasing a product made by one of Australia's leading suppliers.

All products brought to you by Gardenline® are manufactured to the highest standards of performance and safety, and, as part of our philosophy of customer service and satisfaction, are backed by our comprehensive 1 Year Guarantee.

Please fill in and return the Guarantee Card to the address provided.

We hope you will enjoy using your purchase for many years to come.

AFTER SALES SUPPORT



1300 922 271



service.australia@einhell.com

MODEL NUMBER:BG-EH 3551T, 04/11

02

Important!

When using the equipment, a few safety precautions must be observed to avoid injuries and damage. Please read the complete operating instructions and safety regulations with due care. Keep this manual in a safe place, so that the information is available at all times. If you give the equipment to any other person, hand over these operating instructions and safety regulations as well. We cannot accept any liability for damage or accidents which arise due to a failure to follow these instructions and the safety instructions.

1. Safety regulations

The corresponding safety information can be found in the enclosed booklet.

CAUTION!

Read all safety regulations and instructions. Any errors made in following the safety regulations and instructions may result in an electric shock, fire and/or serious injury.
Keep all safety regulations and instructions in a safe place for future use.

Explanation of the plate (see Fig. 13)

1. **Warning**
2. **Keep out of the rain and protect from getting wet.**
3. **Read the operating instructions before using for the first time.**
4. **Pull the plug from the power supply immediately if the cable gets damaged or severed.**
5. **Wear eye, hearing and head protection.**
6. **Wear safety boots.**
7. **Wear safety gloves.**
8. **Pull the power plug before carrying out maintenance, cleaning and repair work.**
9. **Keep all other persons away from the danger zone.**
10. **Maintain a safety distance of at least 10 m from overhead lines**

1. **Cutter rail**
2. **Hand guard**
3. **Steady grip**
4. **Handle**
5. **Cable strain-relief clamp**
6. **Power cable**
7. **Cutter guard**
8. **Impact grip**
9. **ON/OFF switch**
10. **Safety switch**
11. **Locking knob**
12. **Extension bar**
13. **Fastening screws for hand guard**

Important! You must never use the hedge trimmer without hand guard.

Proper use

Important! This hedge trimmer is designed for the trimming of hedges, bushes and shrubs.

The machine is to be used only for its prescribed purpose. Any other use is deemed to be a case of misuse. The user / operator and not the manufacturer will be liable for any damage or injuries of any kind caused as a result of this.

Please note that our equipment has not been designed for use in commercial, trade or industrial applications. Our warranty will be voided if the machine is used in commercial, trade or industrial businesses or for equivalent purposes

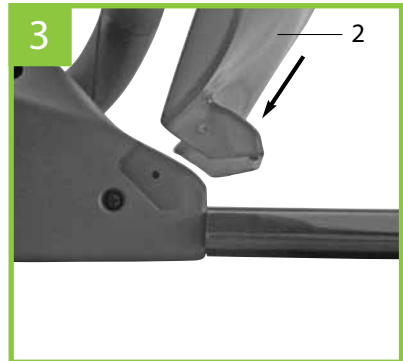
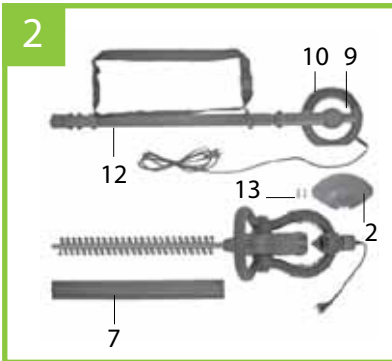
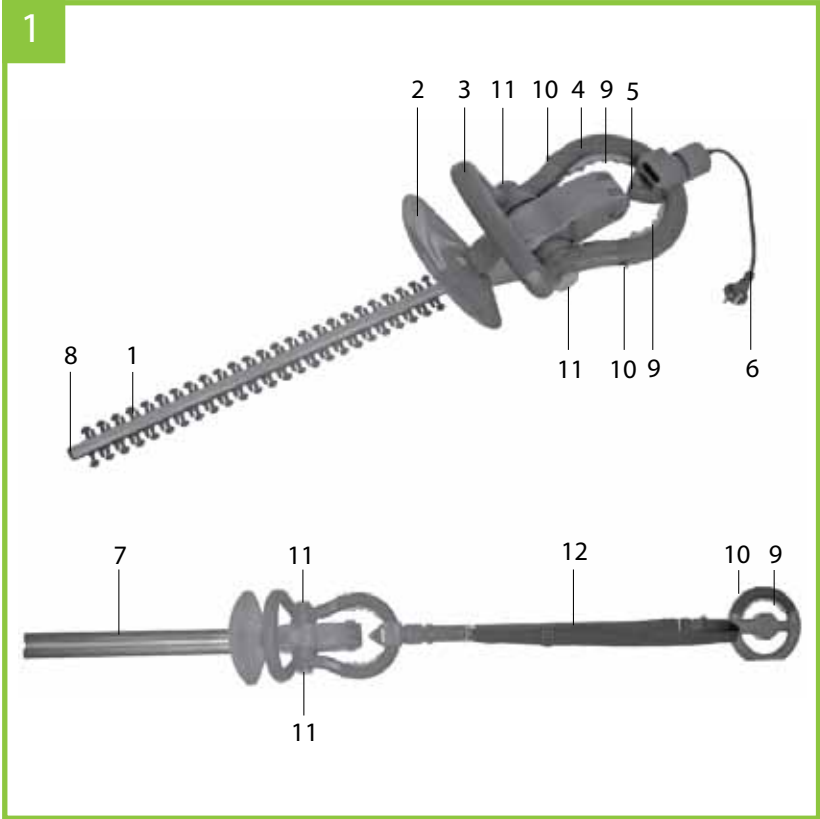

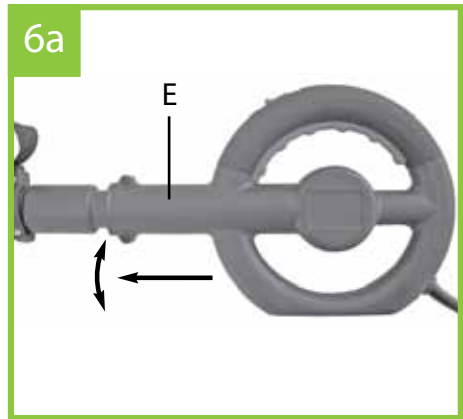
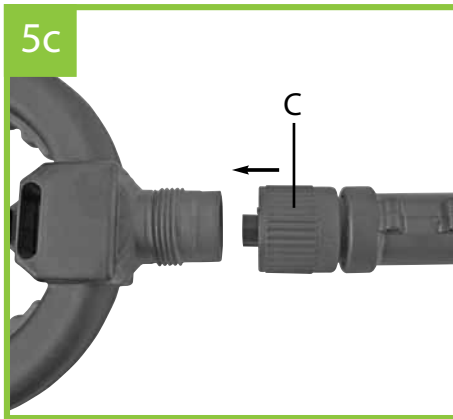
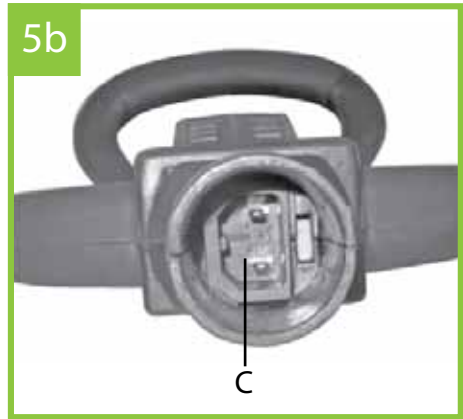
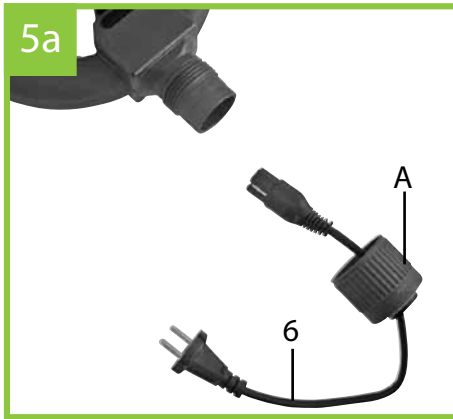
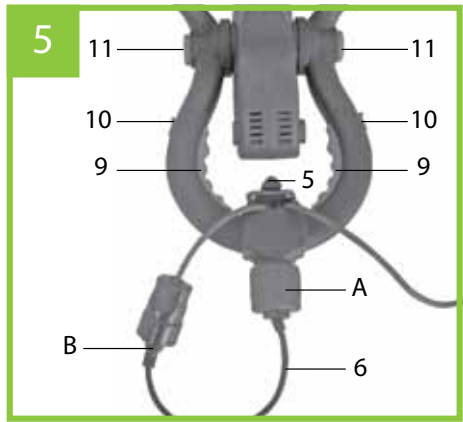
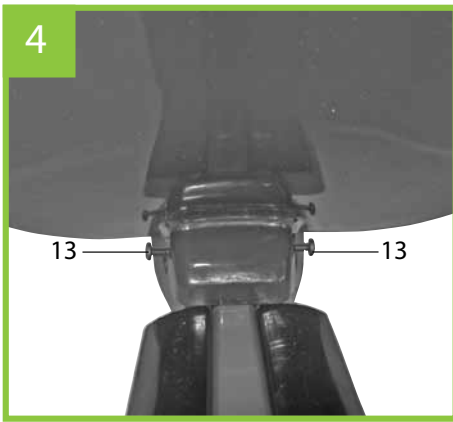

AFTER SALES SUPPORT



6b

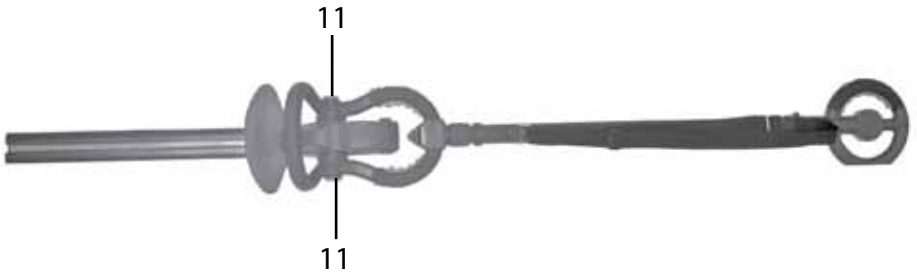

6c



7

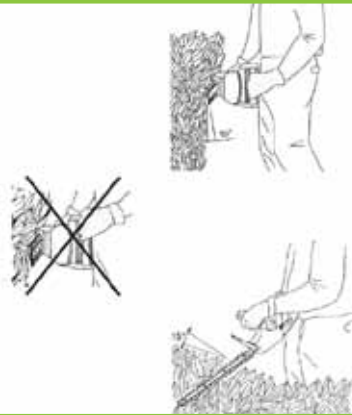

8

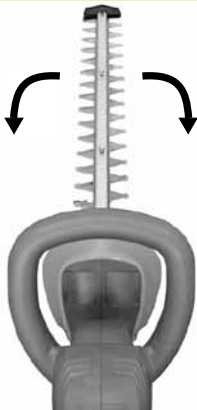

9

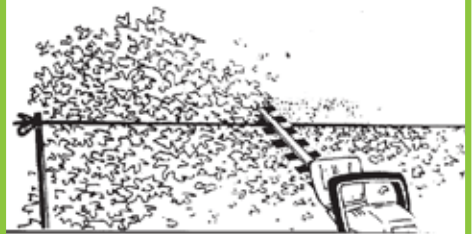

AFTER SALES SUPPORT



1300 922 271



service.australia@einhell.com

MODEL NUMBER:BG-EH 3551T, 04/11

06

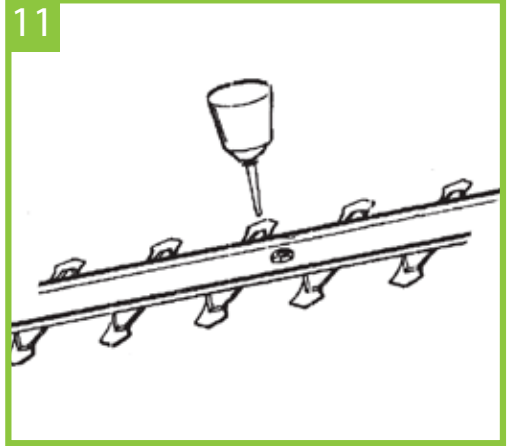
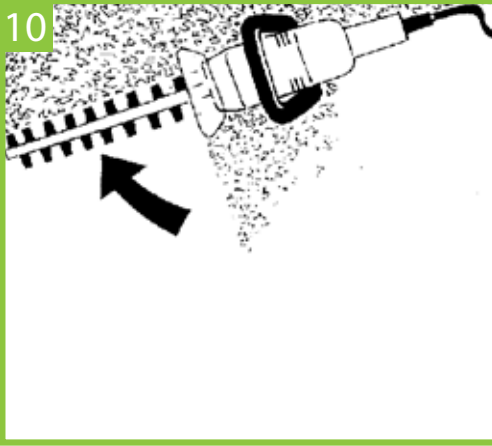

13

1	2	3	4	5
6	7	8	9	10

AFTER SALES SUPPORT

Voltage	240V ~ 50Hz
Power consumption	350 W
Cutting length	510 mm
Cutter rail length	600 mm
Tooth spacing	8 mm
Cuts/min	2700/min
Sound power level L_{WA}	77.4 dB
Sound pressure level L_{PA}	90.4 dB
K_{WA} uncertainty	3.0 dB(A)
Vibration a_{hv}	4.33 m/s ²
K uncertainty	1.5 m/s ²
Weight	4.7 kg

While pressing the 2 locks (Figure 6b/Item 11) at the same time, the handle can be turned into 5 different positions.

Then release the locks and make sure they lock back into place correctly. The equipment can now be used to cut the tops of hedges as for example shown in Figure 6c.

Operation

Connect the equipment's power supply cable to the plug (Figure 4/Item B) and secure the power cable with the strain-relief clamp (Figure 4/Item 5).

Important. To prevent accidental start-up of the equipment, the cordless hedge trimmer is equipped with a safety switch (Figure 4/Item 10) which must be pressed before the ON/OFF switch (Figure 4/Item 9) can be pressed.

If the ON/OFF switch is released, the equipment switches off. The equipment is fitted with a safety switch and an ON/OFF switch on both sides of the handle, enabling you to select the suitable position depending on the work situation. The extension bar is also fitted with a safety switch and an ON/OFF switch with the same functions. Repeat this process several times so that you are sure that your equipment functions properly.

In so doing, please check the running of the blades.

- Please check that the blades function correctly. The blades cut on both sides and run in opposite directions to each other, for guaranteed high cutting performance and quiet operation.
- Fasten the extension cable to the cable holder before starting to use the machine (see Fig. 4).
- For use in the open air you must only use extension cables certified for the purpose.

Tips on use

- The hedge trimmer can be used not only for trimming hedges but for trimming shrubs and bushes as well.
- For optimum trimming performance, guide the blade teeth at an angle of approx. 15° to the hedge (see Fig. 7).
- Since the blades cut on both sides and run in opposite directions to each other, you can trim in both directions (see Fig. 8).
- To achieve a hedge with a uniform height it is recommended that you stretch a piece of string along the edge of the hedge for guidance. Then simply cut away all twigs projecting above the line (see Fig. 9).
- The sides of the hedge should be trimmed with arc-type movements from below upwards (see Fig. 10).

Before starting the equipment

Before you connect the equipment to the mains supply make sure that the data on the rating plate are identical to the mains data.

Fitting the hand guard

Slide on the hand guard (Figure 3a/Item 2) in the direction indicated by the arrow (Figure 3a) Then secure with 2 screws (Figure 3b/Item 13) (Figure 3b).

Fitting the extension bar

Undo the union nut (Figure 4/Item A) and remove from the equipment complete with the power cable (Figure 5a/Item 6). When fitting the extension bar, make sure the plug-in contact (Figure 5b/Item C) is installed in the correct direction. Then secure the extension cable with the union nut (Figure 5c/Item D).

Adjustable handle on the extension bar

Push the handle (Figure 6a/Item E) in the direction indicated by the arrow and hold. You can now turn the handle (Figure 6a/Item E) in steps of 90°. Release the handle and make sure it locks into place correctly. The extension bar is equipped with an adjustable carrying strap (Figure 1/Item 12) for user-friendly handling.

Replacing the power cable **7**

If the power cable for this equipment is damaged, it must be replaced by the manufacturer or its after-sales service or similarly trained personnel to avoid danger.

Cleaning, maintenance and ordering of spare parts **8**

Always pull out the mains power plug before starting any cleaning work.

8.1 Cleaning

- Keep all safety devices, air vents and the motor housing free of dirt and dust as far as possible. Wipe the equipment with a clean cloth or blow it with compressed air at low pressure.
- We recommend that you clean the device immediately each time you have finished using it.
- Clean the equipment regularly with a moist cloth and some soft soap. Do not use cleaning agents or solvents; these could attack the plastic parts of the equipment. Ensure that no water can seep into the device.

8.2 Carbon brushes

In case of excessive sparking, have the carbon brushes checked only by a qualified electrician. Important! The carbon brushes should not be replaced by anyone but a qualified electrician.

Disposal and recycling **9**

The unit is supplied in packaging to prevent its being damaged in transit. This packaging is raw material and can therefore be reused or can be returned to the raw material system.

The unit and its accessories are made of various types of material, such as metal and plastic. Defective components must be disposed of as special waste. Ask your dealer or your local council.

Faults **10**

The machine does not start:

Check that the power cable is correctly connected and check the mains fuses. If the machine still does not work even with connected voltage, please send it to the specified customer services address.

AFTER SALES SUPPORT



1300 922 271



service.australia@einhell.com

MODEL NUMBER:BG-EH 3551T, 04/11

AFTER SALES SUPPORT



GARDENLINE®

Electric Hedge Trimmer

User Guide

