



PROFESSIONAL TOOL TROLLEY

USER GUIDE

Important: retain for future reference - please read carefully.

Now you have purchased a Workzone® product you can rest assured in the knowledge that as well as your 3 year parts and labour guarantee you have the added peace of mind of dedicated helplines and web support.

AFTER SALES SUPPORT

 1300 922 271  service.australia@einhell.com

WW 154

08/2013

Congratulations!

You have made an excellent choice with the purchase of this quality Workzone® product.

By doing so you now have the assurance and peace of mind which comes from purchasing a product that has been manufactured to the highest standards of performance and safety, supported by the high quality standards of ALDI.

We want you to be completely satisfied with your purchase so this Workzone® product is backed by a comprehensive manufacturer's 3 year warranty and an outstanding after sales service through our dedicated Helpline.

We hope you will enjoy using your purchase for many years to come.

If you require technical support or in the unlikely event that your purchase is faulty please telephone our Helpline for immediate assistance. Faulty product claims made within the 3 year warranty period will be repaired or replaced free of charge provided that you have satisfactory proof of purchase (keep your till receipt safe!). This does not affect your statutory rights. However, be aware that the warranty will become null and void if the product is found to have been deliberately damaged, misused or disassembled.



Table of contents

04	Safety information
06	Items supplied
07	Layout
08	Use
09	Before putting into operation
11	Operation
12	Information
13	Guarantee Certificate



Safety information

1

Important.

When using equipment, a few safety precautions must be observed to avoid injuries and damage. Please read the complete operating instructions and safety information with due care. Keep these operating instructions in a safe place so that the information is available at all times. If you give the equipment to any other person, hand over these operating instructions and the safety information as well. We cannot accept any liability for damage or accidents which arise due to a failure to follow these instructions and the safety information.

CAUTION

Read all the safety regulations and instructions. Any errors made in following the safety information and instructions set out below may result in an electric shock, fire and/or serious injury.

Keep all safety information and instructions in a safe place for future use.

Additional safety instructions:

- When loading and unloading the drawers, ensure that the professional tool trolley and the drawers are evenly loaded.
- It is prohibited to transport persons with the professional tool trolley.
- Apply the brake when loading and unloading.
- On slopes or uneven floors ensure that the professional tool trolley does not topple.
- When moving the professional tool trolley on slopes, hold it by the handle.
- Make sure that the maximum total load is not exceeded. (150 kg)



Always push the tool trolley to avoid injury.

Check for damage before use. Use the tool trolley only if it is in a faultless and safe operational condition. Any changes, modifications or additions to the trolley are prohibited.

Any use of accessories or spare parts which are not expressly recommended by the manufacturer can result in injury or damage. Use only genuine accessories and spare parts. The tool trolley is not a toy. Keep it out of reach of children.

Store it in a location which is not accessible to children. The ideal storage temperature is 10 - 30°C.



Items supplied

2

- Open the packaging and take out the equipment with care.
- Remove the packaging material and any packaging and/or transportation braces (if available).
- Check to see if all items are supplied.
- Inspect the equipment and accessories for transport damage.
- If possible, please keep the packaging until the end of the guarantee period.

Important!

The equipment and packaging material are not toys. Do not let children play with plastic bags, foils or small parts. There is a danger of swallowing or suffocating!

- 1 x Tool Trolley
- 2 x Keys
- 4 x Wheels
- Instruction Manual
- Warranty Card
- Warranty Sticker

Tools required:

- Open-ended wrench
- Screwdriver



Layout

3

1. Professional tool trolley
2. Keys
- 3a 2 casters, rigid
- 3b 2 casters, both of which can be swiveled and locked
4. Emergency release (bottom)
5. Lock
6. Handle
7. Worktop
8. Drawer
9. Assembly material (not shown)
10. Assembly and operating instructions (not shown)



7

AFTER SALES SUPPORT



1300 922 271



service.australia@einhell.com

WW 154
08/2013

Use



The tool trolley is designed for mobile storage of tools and small parts. It can be used on a variety of (firm and flat) floor coverings, and it is intended for interior use.

The trolley may be used only for the intended purpose. Any other use is deemed to be a case of misuse. The user/operator and not the manufacturer will be liable for any damage or injuries of any kind caused as a result of this.

Please note that our equipment has not been designed for use in commercial, trade or industrial applications. Our warranty will be voided if the equipment is used in commercial, trade or industrial businesses or for equivalent purposes.

Technical data

- Dimensions approx. 687 x 873 x 458 mm
- Net weight: approx. 56 kg
- The top surface holds up to 100 kg / capacity per drawer see illustration
- Max. load capacity 150 kg

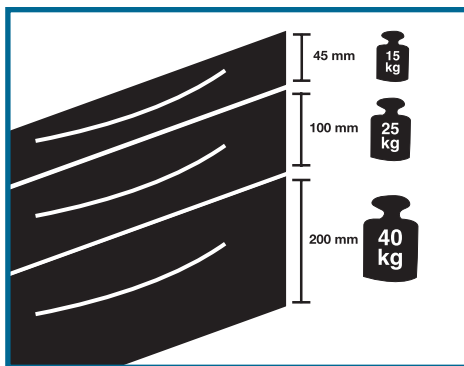

Before putting into operation

5

Assembly

⚠ Important: To avoid malfunctions, please note that all the drawers must be COMPLETELY closed before you pull one out!

- One handle (6) is included, and it can be mounted on the left or right. (Figure 2).
- For details of how to mount the wheels (3), please refer to Figure 3 and turn the tool trolley on its top.
- For good maneuverability, fit the two swiveling and lockable casters (3b) to the same side on which the handle is mounted.
- Fasten each of the casters to the tool trolley using 4 screws, 4 spring washers and 4 standard washers.

If problems arise with the drawers, please refer to the following instructions:

What to do if,

a drawer cannot be closed properly:

- Lock and unlock the lock until you hear a loud "click".
- Open a second drawer and then close both drawers simultaneously or
- Activate the emergency release (4). This is done by moving the emergency release on the underside of the professional tool trolley. This will release the lock on the professional tool trolley (see Figs. 4 - 6).

none of the drawers can be opened, although the lock is not locked:

- Lock and unlock the lock until you hear a loud "click".
- Activate the emergency release (4) (see Figs. 4 - 6).



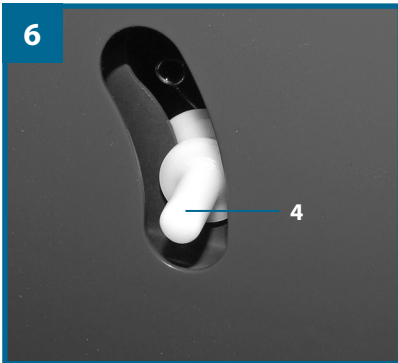
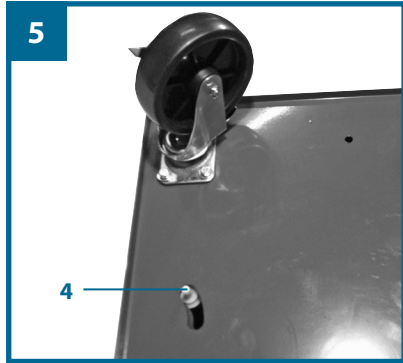
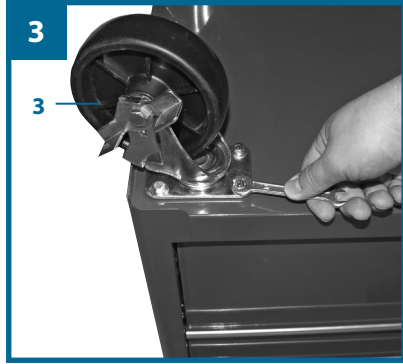
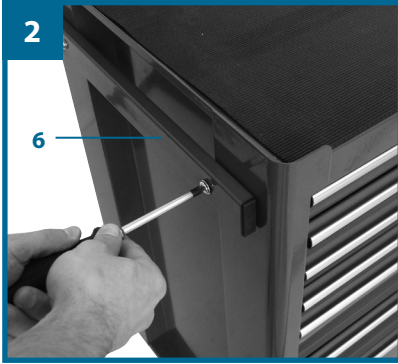

- The keys (2) for the professional tool trolley (1) are in two different places. One is attached to the packaging of the professional tool trolley, the other to the instructions for the professional tool trolley.
- Please keep the keys safe in different places, but NEVER in the professional tool trolley.
- After transportation and/or assembly make sure that all drawer compartments are completely closed.
- For safety reasons the professional tool trolley is equipped with pull-out stops for the drawers. This prevents several drawers being opened at the same time.

Important:

Always apply the brakes on the swivel casters when the trolley is stationary. Failure to do so poses a significant safety hazard.

Always lock the drawers before moving the trolley. Unintentional opening of the drawers while the trolley is being moved can cause the trolley to tip over, creating the risk of personal injury or property damage. After locking the trolley with the key, remove the key to ensure that the trolley remains locked.

Note: A small indicator is located at the top of the lock (Figure 7, item 2a) which shows whether the lock is in the locked or unlocked position (red = locked, green = unlocked).



Cleaning

Clean the professional tool trolley with a slightly damp cloth and if necessary a small amount of conventional paint cleaner. To avoid damaging the surfaces do not use solvents or other aggressive or scouring cleaning products.

Ordering spare parts

Please provide the following information on all orders for spare parts:

- Model/type of the equipment
- Article number of the equipment
- ID number of the equipment
- Spare part number of the required spare part

For our latest prices and information please go to www.isc-gmbh.info

The spare part number of the key can be found on the flat face of the key and on the lock (Fig. 7/8).

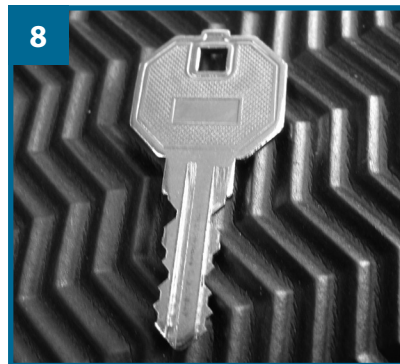
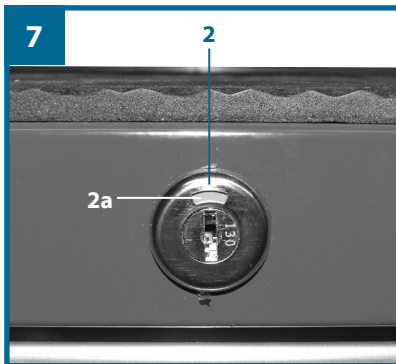

Guarantee Certificate **8**

Congratulations!

08/2013

You have made an excellent choice of this quality product. Our commitment to quality also includes our service. Should you, contrary to expectations, experience defects due to manufacturing faults, ALDI will provide you with a warranty against defects as follows:

Warranty

The product is guaranteed to be free from defects in workmanship and parts for a period of 36 months from the date of purchase. Defects that occur within this warranty period, under normal use and care, will be repaired, replaced or refunded at our discretion. The benefits conferred by this warranty are in addition to all rights and remedies in respect of the product that the consumer has under the Competition and Consumer Act 2010 and similar state and territory laws.

Our goods come with guarantees that cannot be excluded under the Australian Consumer Law. You are entitled to a replacement or refund for a major failure and for compensation for any other reasonably foreseeable loss or damage. You are also entitled to have the goods repaired or replaced if the goods fail to be of acceptable quality and the failure does not amount to a major failure.

Proof of Purchase

This warranty is valid for the original purchase and is not transferable. Please keep your purchase docket, tax invoice or receipt as the best proof of purchase, and as proof of date on which the purchase was made.

Extent of Warranty

This warranty is limited to defects in workmanship or parts. All defective products or parts will be repaired or replaced. This warranty does not cover batteries or any other consumable items.

Normal Wear and Tear

This warranty does not cover normal wear and tear to the products or parts.

Exclusions

This warranty does not cover:

- Any defects caused by an accident, misuse, abuse, improper installation or operation, lack of reasonable care, unauthorised modification, loss of parts, tampering or attempted repair by a person not authorised by the distributor.
- Any product that has not been installed, operated or maintained in accordance with the manufacturer's operating instructions provided with the product.
- Any product that has been used for purposes other than domestic use.
- Any damage caused by improper power input or improper cable connection.

To Make a Claim

This warranty against defects is provided by ALDI Stores, Locked Bag 56, St Marys Delivery Centre, NSW 2760, Phone (02) 9675 9000. If a defect in the goods appears within 36 months you are entitled to claim a warranty, please contact or send all warranty claims to:

Einhell Australia Pty. Ltd.

6/166 Wellington Street, Collingwood, VIC 3066, Australia

Telephone: 1300 922 271 (Operating Hours: Mon-Fri 8:30am to 5:30pm EST)

Email: service.australia@einhell.com

When making a return, please ensure the product is properly packaged so as to ensure that no damage occurs to the product during transit.

Please provide the original or a copy of the proof of purchase. Also please make sure you have included an explanation of the problem.

Please note upon receiving your warranty claim, the supplier will send, via the post or email, a repair and refurbished goods or parts notice. Please provide your email address and advise the supplier, if you wish to obtain a repair and refurbished goods or parts notice via email.



EH 01/2013 (01)