

## Battery protection system

The tool is equipped with the battery protection system, which helps to ensure a long service life.

The output power automatically cuts off during operation when the tool and/or battery are placed under the following situations:

### • When the tool is overloaded:

If this occurs, release the trigger switch and remove causes of overload, then pull the switch trigger again to restart.

### • When the remaining battery capacity becomes low:

Recharge the battery pack.

**Note:** The battery protection system does not in any way damage the tool.

**Note:** The indicated capacity may be lower than the actual level during use or immediately after using the tool.

## MAINTENANCE

**WARNING! ALWAYS ENSURE THE TOOL HAS COMPLETELY STOPPED AND THE BATTERY IS REMOVED PRIOR TO ANY MAINTENANCE.**

- Keep air intake clean and air vents free of debris to avoid overheating the motor.

- Do not use cleaning agents to clean the plastic parts of the tool. A mild detergent on a damp cloth is recommended. Water must never come into contact with the tool.

- If the blower vibrates abnormally, stop motor immediately. Abnormal vibration usually indicates a mechanical problem continued operation could lead to injury or damage.

- No lubrication is necessary as the motor is equipped with lifetime-lubricated bearings.

Note: Ozito Industries will not be responsible for any damage or injuries caused by the repair of the blower by an unauthorised person or by mishandling of the blower. This tool is designed for DIY use - use in commercial or industrial environments will void the warranty.

## TROUBLESHOOTING

Problem	Cause	Remedy
Blower is not starting	Possible clogging	Clean the blower tube and blower outlet of any leaves or debris.
	Battery is low in charge	Charge battery
	Battery not inserted properly	Insert battery pack correctly
Blower is not operating at full capacity	Possible clogging	Clean the blower tube and blower outlet of any leaves or debris.
Motor stops while blowing	Battery has no power	Charge battery

## SPARE PARTS

Spare parts can be ordered from the Special Orders Desk at your local Bunnings Warehouse or Homebase store.

For further information, or any parts visit

[www.ozito-diy.co.uk](http://www.ozito-diy.co.uk) or contact Ozito Customer Service:

Great Britain: 0151 294 4488

Ireland: 1850 882711







E-mail: [enquires@ozito-diy.co.uk](mailto:enquires@ozito-diy.co.uk)

## BATTERY AND CHARGER SAFETY WARNINGS

THIS MANUAL CONTAINS IMPORTANT SAFETY AND OPERATING INSTRUCTIONS FOR YOUR BATTERY CHARGER.

- Before using the charger read all instructions and cautionary markings on the charger, battery pack and the product using the battery pack.
- This charger is not intended for any uses other than charging rechargeable batteries. Any other use may result in risk of fire, electric shock or electrocution.
- Do not place any object on top of the charger or place the charger on a soft surface that may result in excessive internal heat. Place the charger in a position away from any heat source.
- To reduce risk of damage to the electric plug and cord, pull by the plug rather than the cord when disconnecting the charger.
- Make sure the cord is located so that it will not be stepped on, tripped over, or otherwise subjected to damage or stress.
- An extension cord should not be used unless absolutely necessary. Use of an improper extension cord could result in the risk of fire, electric shock or electrocution.
- Do not operate the charger if it has received a sharp blow, been dropped or otherwise damaged in any way. Have it checked by an electrician or power tool repairer.
- Do not disassemble charger. Take it to an electrician or power tool repairer when service or repair is required. Incorrect reassembly may result in a risk of electric shock, electrocution or fire.
- To reduce risk of electric shock, unplug the charger from the outlet before attempting any cleaning. Removing the battery pack will not reduce this risk.
- Never attempt to connect 2 chargers together.
- DO NOT store or use the tool and battery pack in locations where the temperature may reach or exceed 40°C (such as inside sheds or metal buildings in summer).
- The charger is designed to operate on standard household electrical power (240 volts). Do not attempt to use it on any other voltage!
- The battery pack is not fully charged out of the carton. First read the safety instructions and then follow the charging notes and procedures.
- The longest life and best performance can be obtained if the battery pack is charged when the air temperature is between 18 - 24°C. Do not charge the battery pack in an air temperature below 10°C or above 40°C. This is important and will prevent damage to the battery pack.
- Do not incinerate the battery pack even if it is seriously damaged or is completely worn out. The battery can explode in a fire.
- Never attempt to open the battery pack for any reason. If the plastic housing of the battery pack breaks or cracks, immediately discontinue use and do not recharge.
- During charging, the battery must be placed in a well ventilated area.

## DESCRIPTION OF SYMBOLS

<b>V</b>	Volts	<b>Hz</b>	Hertz
<b>~</b>	Alternating current	<b>W</b>	Watts
<b>dc/---</b>	Direct current	$\varnothing$	Diameter
<b>mA</b>	Milliamperes	<b>No</b>	No load speed
<b>/min</b>	Revolutions or reciprocation per minute		Double insulated
	Read instruction manual		Warning
	Decibel level		Wear eye and ear protection.
 	Keep bystanders away. Do not operate whilst people especially children or pets are in the area.		

## ELECTRICAL SAFETY

**WARNING! When using mains-powered tools, basic safety precautions, including the following, should always be followed to reduce risk of fire, electric shock, personal injury and material damage.**

Read the whole manual carefully and make sure you know how to switch the tool off in an emergency, before operating the tool.

Save these instructions and other documents supplied with this tool for future reference.

Before you connect the charger to the mains supply make sure that the data on the rating plate are identical to the mains data.



This tools charger is double insulated therefore no earth wire is required.

If the supply cord is damaged, it must be replaced by an electrician or a power tool repairer in order to avoid a hazard.

## GENERAL POWER TOOL SAFETY WARNINGS

**WARNING! Read all safety warnings and all instructions.** Failure to follow the warnings and instructions may result in electric shock, fire and/or serious injury.

**Save all warnings and instructions for future reference. The term "power tool" in the warnings refers to your mains-operated (corded) power tool or battery-operated (cordless) power tool.**

- Work area safety**
  - Keep work area clean and well lit.** Cluttered or dark areas invite accidents.
  - Do not operate power tools in explosive atmospheres, such as in the presence of flammable liquids, gases or dust.** Power tools create sparks which may ignite the dust or fumes.
  - Keep children and bystanders away while operating a power tool.** Distractions can cause you to lose control.
- Electrical safety**
  - Power tool plugs must match the outlet. Never modify the plug in any way. Do not use any adapter plugs with earthed (grounded) power tools.** Unmodified plugs and matching outlets will reduce risk of electric shock.
  - Avoid body contact with earthed or grounded surfaces, such as pipes, radiators, ranges and refrigerators.** There is an increased risk of electric shock if your body is earthed or grounded.
  - Do not expose power tools to rain or wet conditions.** Water entering a power tool will increase the risk of electric shock.
  - Do not abuse the cord. Never use the cord for carrying, pulling or unplugging the power tool. Keep cord away from heat, oil, sharp edges or moving parts.** Damaged or entangled cords increase the risk of electric shock.
  - When operating a power tool outdoors, use an extension cord suitable for outdoor use.** Use of a cord suitable for outdoor use reduces the risk of electric shock.
  - If operating a power tool in a damp location is unavoidable, use a residual current device (RCD) protected supply.** Use of an RCD reduces the risk of electric shock.
- Personal safety**
  - Stay alert, watch what you are doing and use common sense when operating a power tool. Do not use a power tool while you are tired or under the influence of drugs, alcohol or medication.** A moment of inattention while operating power tools may result in serious personal injury.
  - Use personal protective equipment. Always wear eye protection.** Protective equipment such as dust mask, non-skid safety shoes, hard hat, or hearing protection used for appropriate conditions will reduce personal injuries.
  - Prevent unintentional starting. Ensure the switch is in the off-position before connecting to power source and/or battery pack, picking up or carrying the tool.** Carrying power tools with your finger on the switch or energising power tools that have the switch on invites accidents.
  - Remove any adjusting key or wrench before turning the power tool on.** A wrench or a key left attached to a rotating part of the power tool may result in personal injury.
  - Do not overreach. Keep proper footing and balance at all times.** This enables better control of the power tool in unexpected situations.

**Note:** Double insulation does not take the place of normal safety precautions when operating this tool. The insulation system is for added protection against injury resulting from a possible electrical insulation failure within the tool.

The power supply for this products charger should be protected by a residual current device (rated at 30mA or less). A residual current device reduces the risk of electric shock.



18V LITHIUM ION

## CORDLESS BLOWER

### ORIGINAL INSTRUCTIONS

#### SPECIFICATIONS

Voltage:	18V
No Load Speed:	12,000/min
Max. Air Speed:	210km/hr
Weight:	1.35kg

[ozito-diy.co.uk](http://ozito-diy.co.uk)

5 YEAR  
REPLACEMENT WARRANTY

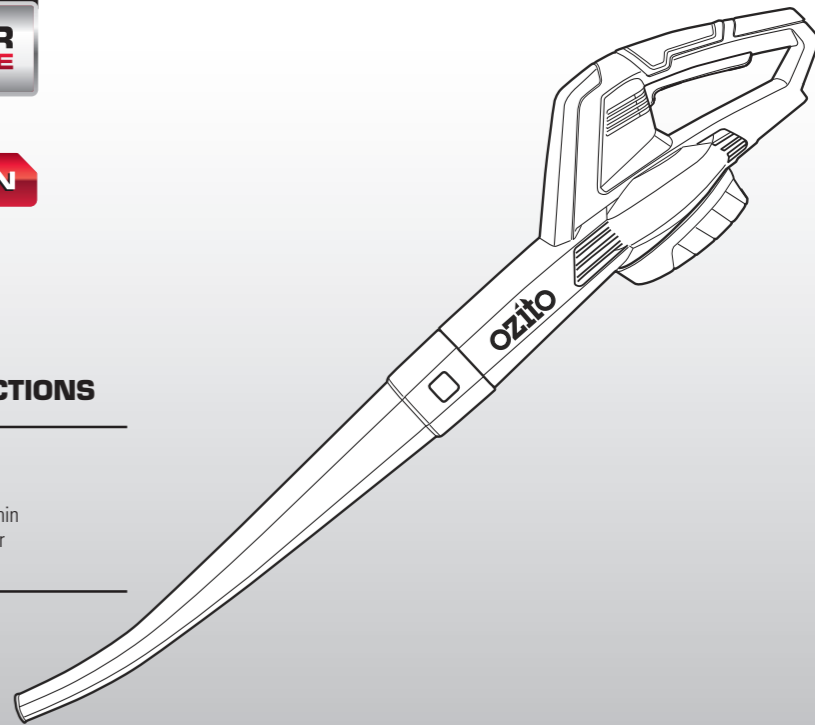

### WHAT'S IN THE BOX



Cordless Blower



Blower Tube

Battery & Charger sold

separately

PXCBL5-018U

## WARRANTY

All of our products undergo strict quality checks to ensure that they reach you in perfect condition. In the unlikely event that your device develops a fault, please contact our service department at the address shown on this guarantee card. You can also contact us by telephone using the customer service number shown. Please note the following terms under which guarantee claims can be made:

- These warranty terms regulate additional warranty services, which the manufacturer mentioned below promises to buyers of its new products in addition to their statutory guarantee claims are not affected by this guarantee. Our guarantee is free of charge to you.

- The warranty services only covers defects due to material or manufacturing faults on a product which you have bought from the manufacturer mentioned below are limited to either the rectification of said defects on the product or the replacement of the product, whichever we prefer. Please note that our devices are not designed for use in commercial, trade or professional applications. A guarantee contract will not be created if the device has been used by commercial, trade or industrial business or has been exposed to similar stresses during the guarantee period.

- The following are not covered by our guarantee:
  - Damage to the device caused by a failure to follow the assembly instructions or due to incorrect installation, a failure to follow the operating instructions (for example connecting it to an incorrect mains voltage or current type) or a failure to follow the maintenance and safety instructions or by exposing the device to abnormal environmental conditions or by lack of care and maintenance.
  - Damage to the device caused by abuse or incorrect use (for example overloading the device or the use of unapproved tools or accessories), ingress of foreign bodies into the device (such as sand, stones or dust, transport damage), the use of force or damage caused by external forces (for example by dropping it).
  - Damage to the device or parts of the device caused by normal or natural wear or tear or by normal use of the device.

- Your Product is guaranteed for a period of 60 months from the original date of purchase and is intended for DIY (Do It Yourself) use only. Lithium Ion batteries and chargers are

covered by a 12 month warranty. Warranty excludes consumable parts. Guarantee claims should be submitted before the end of the guarantee period within two weeks of the defect being noticed. No guarantee claims will be accepted after the end of the guarantee period. The original guarantee period remains applicable to the device even if repairs are carried out or parts are replaced. In such cases, the work performed or parts fitted will not result in an extension of the guarantee period, and no new guarantee will become active for the work performed or parts fitted. This also applies if an on-site service is used.

IN ORDER TO MAKE A CLAIM UNDER THIS WARRANTY YOU MUST RETURN THE PRODUCT TO THE PLACE OF PURCHASE WITH YOUR REGISTER RECEIPT.

Please refer to the restrictions of this warranty concerning wearing parts, consumables and missing parts as set out in the service information in these operating instructions.

CUSTOMER SERVICE HELPLINE

GB: 0151 294 4488

IRL: 1850 882711

Ozito-diy.co.uk

# KNOW YOUR PRODUCT

## CORDLESS BLOWER

- 1 Blow Tube
- 2 Blow Tube Release Tab
- 3 ON/OFF Switch
- 4 Handle

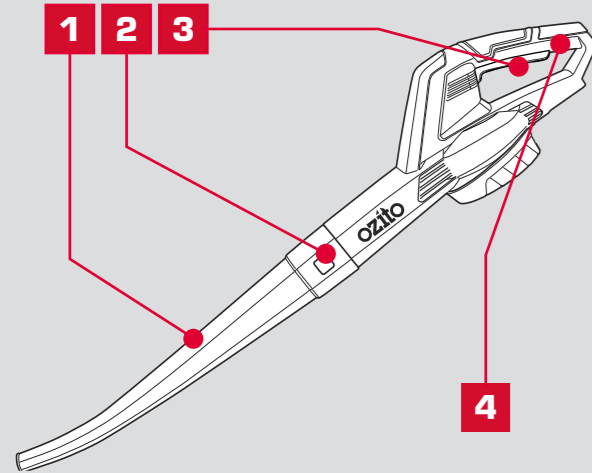

## BATTERY & CHARGER (sold separately)

This tool is compatible with all battery and chargers from the Ozito Power X Change Range.

### ONLINE MANUAL

Scan this QR Code with your mobile device to take you to the online manual.

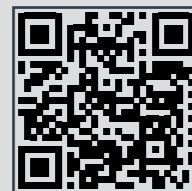

**5 YEAR**  
REPLACEMENT WARRANTY

# SETUP & PREPARATION

## 1. ASSEMBLY

**WARNING!** ENSURE THE TOOL IS SWITCHED OFF AND BATTERY DISCONNECTED BEFORE PERFORMING ANY OF THE FOLLOWING TASKS.

### Fitting the Blower Tube

- Align the blower tube with the outlet of the blower.

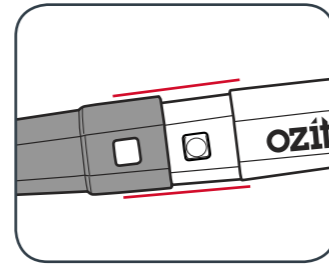

- Push the blower tube onto the blower until it clicks into place.

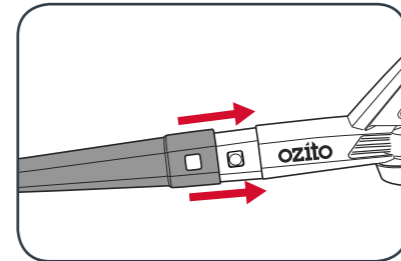

- To remove the blower tube, press the blower tube release tab while pulling the tube away from the housing.

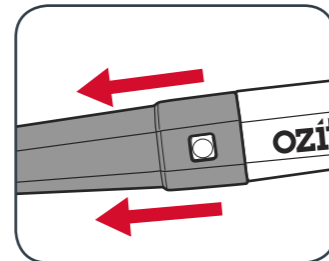

## 2. INSERTING & REMOVING THE BATTERY

### Inserting a Battery (not included) into the Blower

- Align the ribs of the battery with the recess in below the handle.

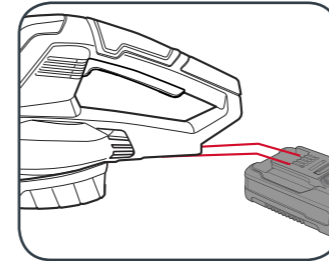

- Slide the battery in so that it clicks into place.

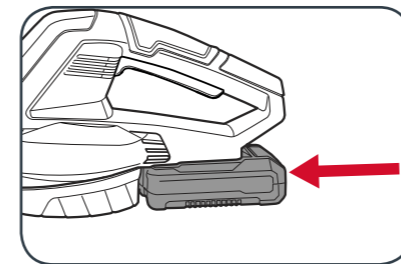

### Removing a Battery from the Blower

- Press and hold the battery release tab to release the battery.

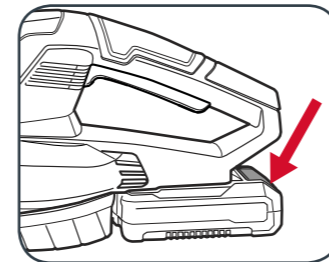

- Slide the battery out.

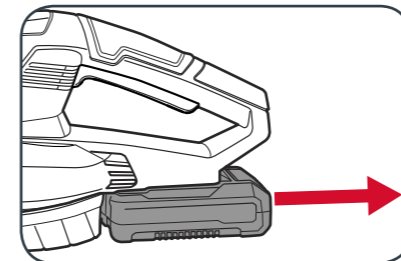

**WARNING!** DO NOT USE ANY ATTACHMENTS OR ACCESSORIES NOT RECOMMENDED BY THE MANUFACTURER OF THIS PRODUCT, AS IT CAN RESULT IN SERIOUS PERSONAL INJURY.

# OPERATION

## 3. CONTROLS & OPERATION

**WARNING!** DO NOT USE THE BLOWER WITH ANY TYPE OF ACCESSORY OR ATTACHMENT. SUCH USAGE MIGHT BE HAZARDOUS.

### Switching On and Off

- To start the blower squeeze the on/off switch.
- To stop the blower release the on/off switch.

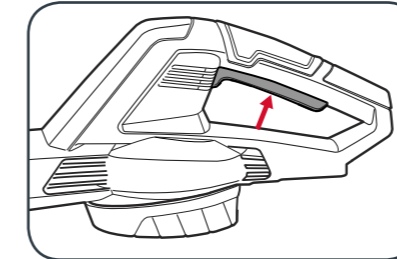

**WARNING!** DO NOT PUT PART OF YOUR BODY SUCH AS HANDS AND FINGERS IN THE VACUUM OPENING OR EXHAUST OPENING.

### Blowing

The blower is ideal for blowing leaves, grass clippings and other debris.

Hold the blower firmly, squeeze the on/off switch, point the jet of air in front of you and move forward slowly. Move the blower from side to side, with the tube several inches above the ground.

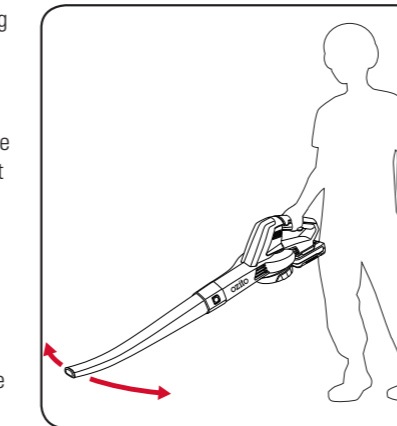

Be careful where you point the jet of air as it can move heavy material and cause injury or damage to bystanders.

**Note:** Be aware of other people and animals in the area where you are to be operating the blower.

**Note:** Avoid collisions with hard objects which could damage your machine.

**WARNING!** DO NOT SWITCH THE BLOWER ON IN ENCLOSED OR POORLY VENTILATED SPACES OR IN THE PRESENCE OF FLAMMABLE AND/OR EXPLOSIVE LIQUIDS, GASES AND POWDERS.

## 4. BATTERY & CHARGING (sold separately)

**CAUTION!** THE CHARGER FOR THIS PRODUCT SHOULD BE PROTECTED BY A RESIDUAL CURRENT DEVICE (RATED AT 30MA OR LESS).

The purchased battery will be shipped in a low charge condition, and requires charging prior to use. Allow several cycles of charging and discharging (through use of the tool) for the battery to reach its optimum performance / runtime.

### Charging your lithium ion battery - Fast Charger

- Connect the charger into a mains power outlet.

- The charger LED will flash green showing power is being supplied to the charger.

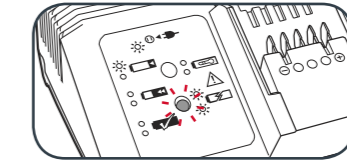

- With the charger sitting on a flat surface, align the raised ribs on the battery with the recess in the charger and slide onto the charger ensuring a firm connection.

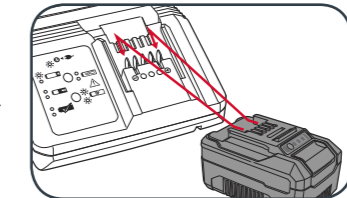

- The charger LED will illuminate red signifying that the battery is charging.



- The charger LED will illuminate green once the battery is charged.



### Charger LED Indicator

LED Indicator	Situation
GREEN (Flashing)	Stand By (no battery pack is inserted)
RED (Flashing)	Battery is charging (low charge)
RED (Illuminated)	Battery is charging (mid charge)
GREEN (Illuminated)	Battery is 95% - 100% charged and ready for use.
BOTH (Illuminated)	Battery pack is too hot or too cold (charging will begin automatically when battery reaches correct charging temperature).
BOTH (Flashing)	Defective battery. Never charge a defective battery pack! Remove battery pack from charger.

## Charging your lithium ion battery - Eco Charger

- Connect the charger into a mains power outlet.

- The charger LED will flash green showing power is being supplied to the charger.

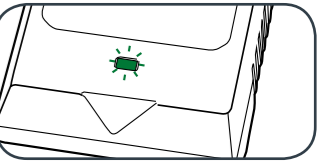

- With the battery sitting on a flat surface, align the raised ribs on the battery with the recess in the charger and slide onto the battery ensuring a firm connection.

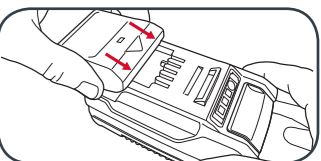

- The charger LED will illuminate red signifying that the battery is charging.

- When removing the charger from the battery, first press the battery release tab, then slide the charger from its position.

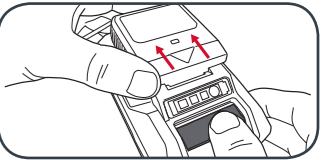

### Charger LED Indicator

LED Indicator	Situation
GREEN (Flashing)	Stand By (no battery pack is inserted)
RED (Illuminated)	Battery is charging (low charge)
GREEN (Illuminated)	Battery is charged and ready for use.
RED (Flashing)	Battery or Charger fault
RED & GREEN (Flashing)	Battery pack is too hot or too cold (remove battery from charger and store at room temperature 20°C. Insert battery again when at correct charging temperature). If this happens again, the battery is defective and needs to be replaced.

### Battery Charge Indicator

The purchased battery is equipped with a battery charge indicator to show the state of the battery charge.

Press the charge indicator button and look to see which LED lights.

- Battery requires immediate charging
- Low state of charge, requires charging soon.
- Mid state of charge
- Full state of charge.

**Note:** The battery needs to be removed from the tool to check the state of charge.