





# Quick Start Guide

**Your Safety is most important  
please read these safety rules before you use this machine**

## General Safety Rules

-  **Read user manual before using the machine**
-  **Wear safety goggles to guard your eyes from possible injury**
-  **Wear gloves to protect your hands**
-  **Wear safety shoes to protect your feet**
-  **Wear hearing protection**

**Note - This quick start guide is intended for experienced users who have already assembled the tool, please refer to the manual for further details**

# Quick Start Guide



## Items Included



Do you have questions?  
 We can help  
 Call Customer Service  
 Mon-Thur 08:45 am - 5:00 pm  
 Friday 08:45 am - 3:15 pm



**0151 649 1500**  
**Spare Parts also available**

- 1 Unpack the Silent Shredder**
  - a) Open carton carefully and remove all items
  - b) Ensure you have all items (see above) before you discard the packaging
- 2 Assemble unit**  
 To assemble this unit please refer to the user manual / instruction booklet

- 3 Now you have assembled the unit**  
 Please ensure the collection box is fully in place and locked in position. This will engage the safety switch (see fig. 3).  
 If the collection box is not locked in place the unit  
**WILL NOT OPERATE**



- 4 Now you are ready to use the unit**  
**Please check**  
 The cable is securely connected to the unit (see Fig. 4)  
 Connected to mains  
 Please remember max size of branches is 40 mm (see Fig. 5)  
 The Cutter/Counter blade setting is pre set at factory and should not need any initial adjustment.  
 However please ensure that the Cutter Blade / Counter blade setting is correct at all items (see Fig 6) 0.5 to 1.0 if not this may result in the unit not functioning correctly. If necessary adjustment can be made via the adjusting knob (see Fig 7)

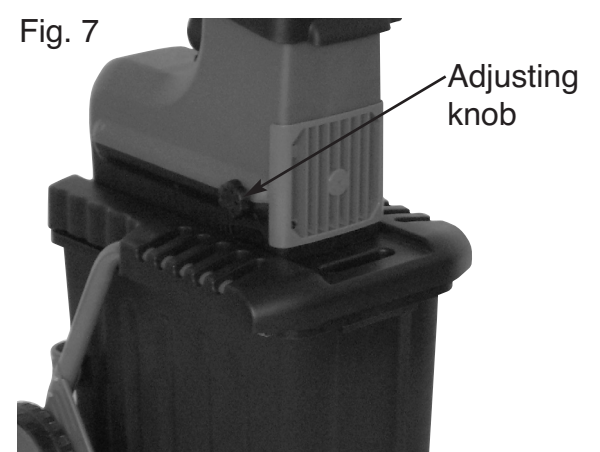
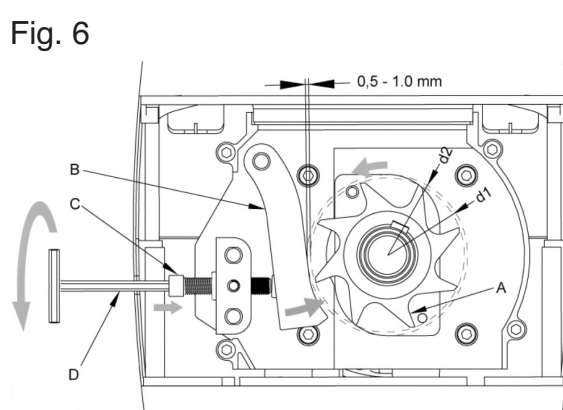
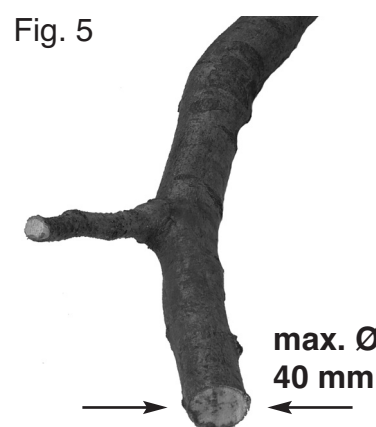

**PLEASE DO NOT OVER ADJUST THIS SO THE COUNTER BLADE MEETS THE CUTTER AS THIS WILL DAMAGE THE BLADE (REFER TO MANUAL)**