



SPEAR & JACKSON

Operating Instructions Garden Blower Vac



Cat-No.: 730-0789

34.360.05
I.-No.: 01027

SPJBV 3200



- Ⓒ Please read these instructions carefully before installing and operating the Garden blower vac!

Petrol Engine Quick Start Guide

Ensure correct fuel/oil mixture 40:1

STARTING

1. Add the correct fuel mixture to unit.
2. Make sure that the Vacuum Bag is fitted correctly, failure to do so and the engine will not start.
3. Set the ON/OFF switch to "I"
4. Press the throttle trigger until it locks.
5. Press the fuel primer ten times.
6. Set the choke lever to "I·I".
7. Hold the machine on the front lever.
8. Pull the starter cable 4 times quickly.
9. Allow the machine to warm up for approx. 10 seconds.
10. Set the choke lever to "I·I"

Note - this quick start guide is intended for experienced users who have already assembled the tool, please refer to the manual for details.

If machine does not start after minimum 6 pulls on starter cord refer to petrol Engine Q & A on page 12.

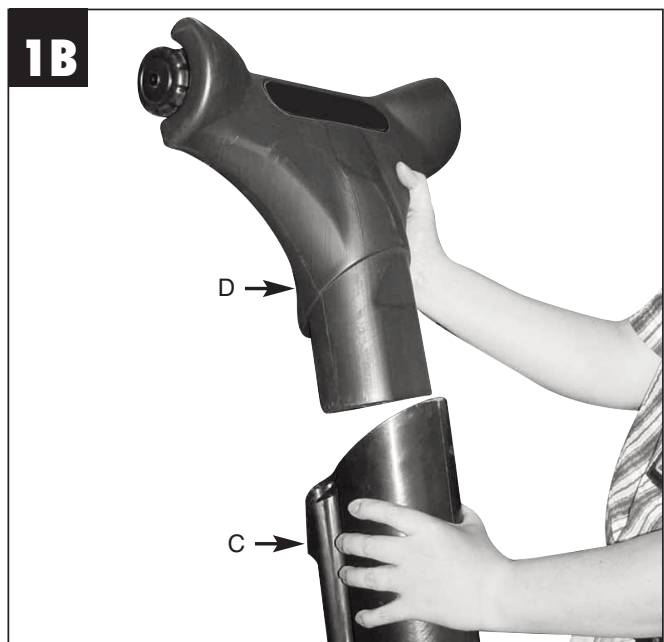
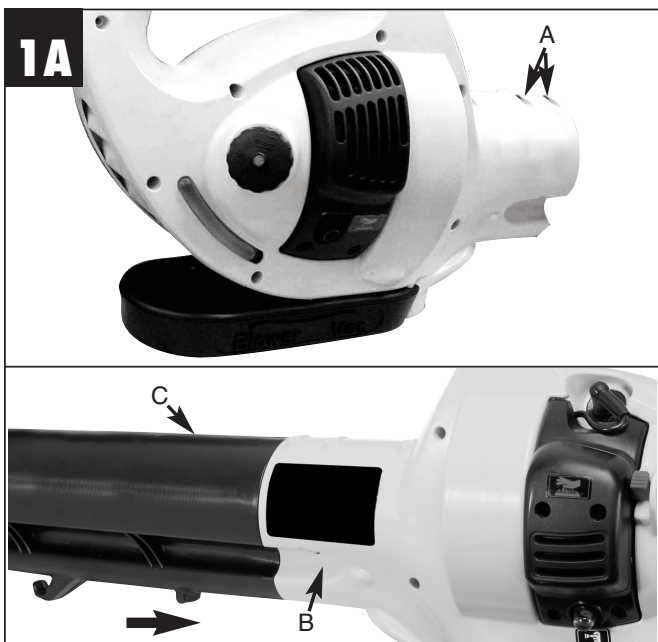
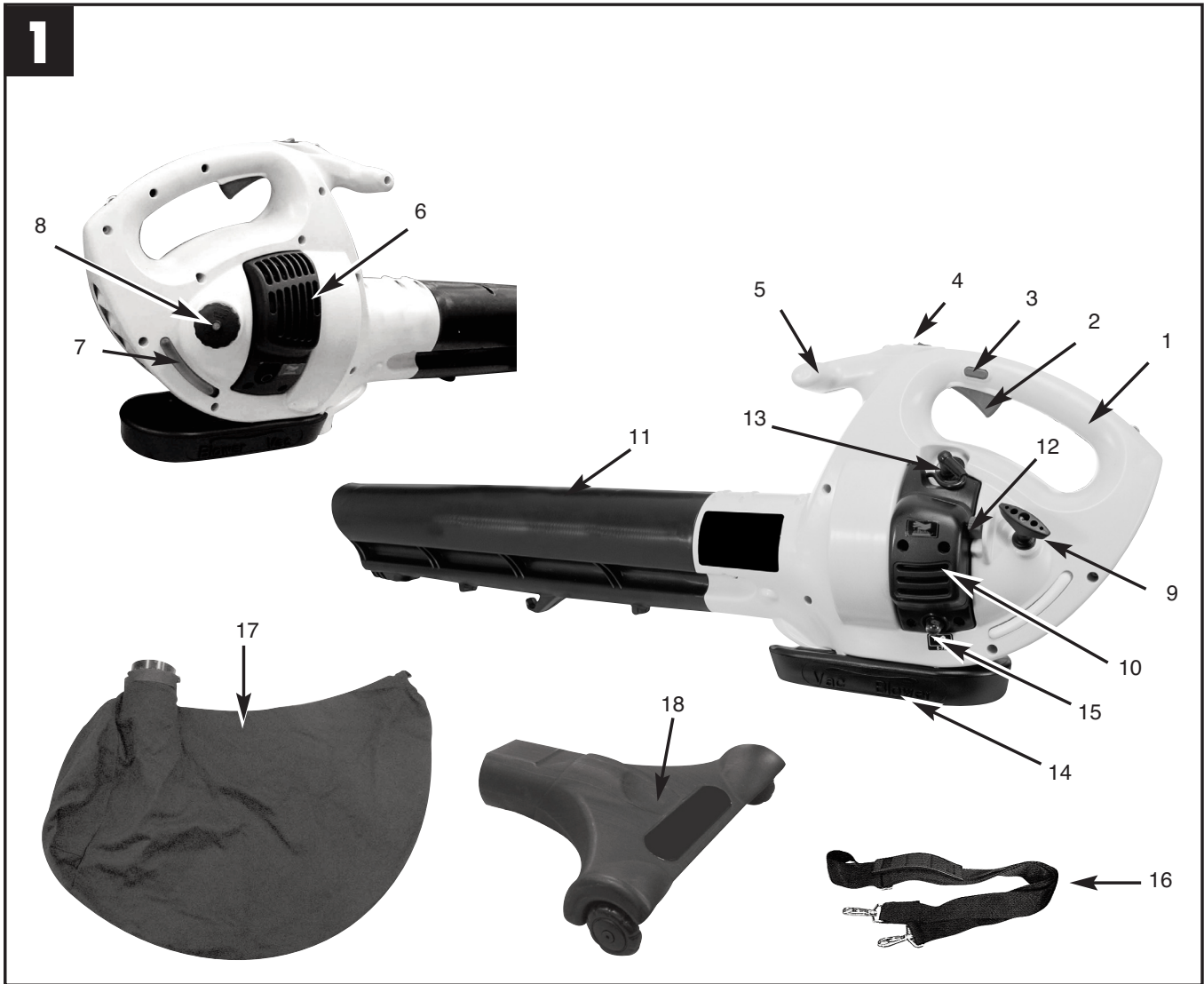

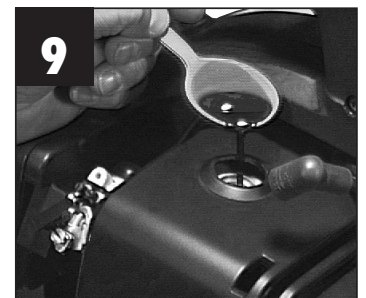
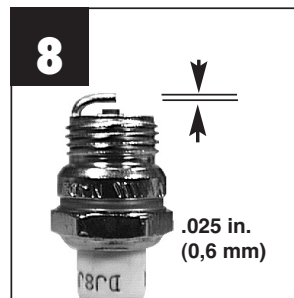
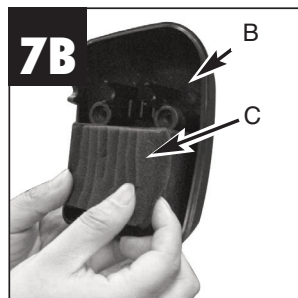
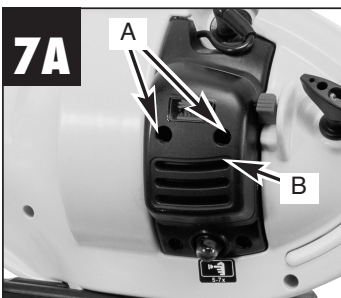
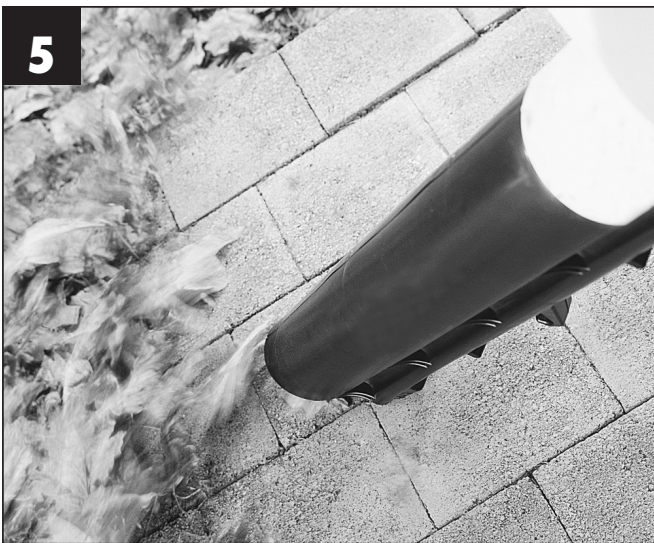
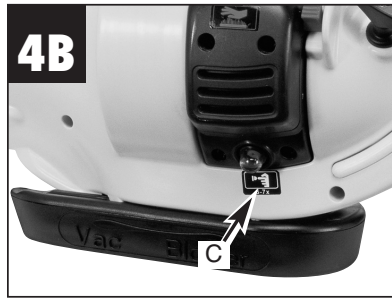
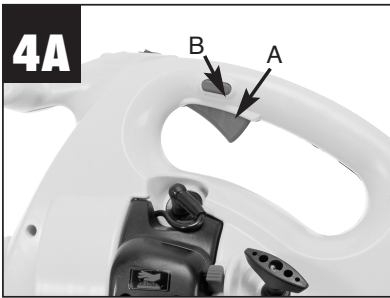
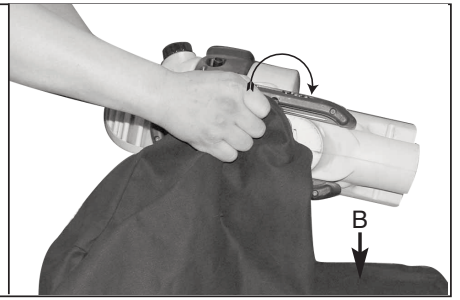
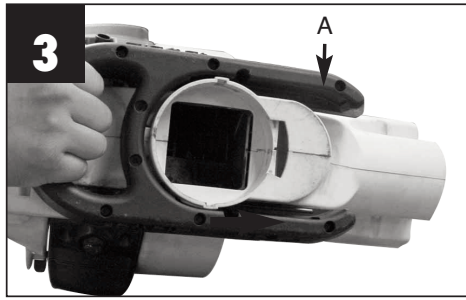
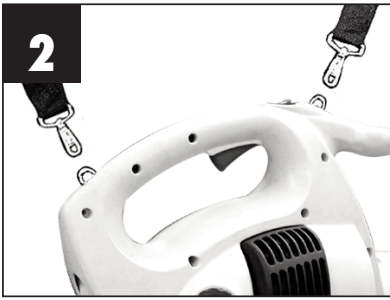











	Read the operating instructions before you use the blower vac.	 5-7x	Fuel pump
	Wear safety goggles to protect your eyes. Wear ear protectors to protect your hearing against the noise.		Never work if people – especially children - or animals are in the danger area.
	Warning! Hazard!		Never allow the blower to run without the blower tube.
	Keep other people away.		Sound power level with EC Directive 2000/14/EC!
	Warning! Hot surface		After the unit is switched off, the motor continues to run for a short while.

Table of contents**Page**

1. General safety regulations	7
2. Machine layout and items supplied	8
3. Technical data	8
4. Assembly	8
5. Operating Instructions	8
6. Maintenance	10
7. Storage	10
8. Ordering replacement parts	10
9. Troubleshooting	11
10. Starting procedure	12

1. GENERAL SAFETY REGULATIONS

READ YOUR USER MANUAL AND ALL SUPPLEMENTS (IF ANY ENCLOSED) THOROUGHLY BEFORE OPERATING YOUR UNIT.

1. WEAR CLOSE FITTING, TOUGH WORK CLOTHING PPE (Personal protective clothing) that will provide protection/without restricting your movements, such as long slacks or trousers, safety work shoes, heavy duty work gloves, hard hat, a safety face shield, or safety glasses for eye protection and a good grade of ear plugs or other sound barriers for hearing protection.
2. REFUEL IN A SAFE PLACE. Open fuel cap slowly to release any pressure which may have formed in fuel tank. Always wipe unit of fuel or oil spills before starting. To prevent a fire hazard, move at least 10 feet (3 meters) from fueling area before starting.
3. TURN UNIT OFF before setting it down, and also before installing or removing attachments.
4. KEEP ALL SCREWS AND FASTENERS TIGHT and the unit in good operating condition. Never operate this equipment if it is improperly adjusted or not completely and securely assembled.
5. KEEP HANDLES DRY, clean and free of fuel mixture.
6. STORE EQUIPMENT AWAY FROM POSSIBLE IGNITION SOURCES, such as gas-powered water heaters, clothes dryers, or oil-fired furnaces, portable heaters, etc.
7. ALWAYS KEEP the engine free of debris build-up.
8. OPERATION OF EQUIPMENT should always be restricted to mature and properly instructed individuals.
9. ALL PERSONS WITH RESPIRATORY PROBLEMS and persons operating blower in very dusty environments, should wear a dust particle mask at all times. Paper dust masks are available at most paint and hardware stores.
10. Use the blower vac only at reasonable times of the day. Do not use early in the morning or late in the evening when people could feel disturbed. Pay attention to your local noise control regulations.
11. Allow the machine to run at the lowest possible motor speed required to carry out the work.
12. Before you start work, use a brush and scraper to remove all dirt from the blower vac.
13. In case of dusty conditions, moisten the surface a little.
14. Use the full-length blower nozzle extension so that the air current can work near to the ground.
15. Watch out for children, pets, open windows etc. and blow the dirt safely away from them.

WHAT NOT TO DO

WARNING: DO NOT USE ANY OTHER FUEL than that recommended in your manual. Always follow instructions in the Fuel and Lubrication section of this manual. Never use fuel unless it is properly mixed with 2-cycle engine lubricant. Permanent damage to engine will result, voiding manufacturer's warranty.

1. DO NOT SMOKE while refueling or operating equipment.
2. DO NOT OPERATE UNIT WITHOUT A EXHAUST and properly installed exhaust shield.
3. DO NOT TOUCH or let your hands or body come in contact with a hot exhaust or spark plug wire.
4. DUE TO THE DANGER of exhaust fumes, never operate blower in a confined or poorly ventilated area.
5. NEVER POINT BLOWER in the direction of people, animals, buildings, automobiles, or windows, etc.
6. DO NOT operate unit without inlet cover installed to prevent contact with impeller.
7. DO NOT set a hot engine down where flammable material is present.
8. DO NOT OPERATE UNIT FOR PROLONGED PERIODS. Rest periodically.
9. DO NOT OPERATE UNIT WHILE UNDER THE INFLUENCE OF ALCOHOL OR DRUGS.

WARNING: DO NOT ADD, REMOVE OR ALTER ANY COMPONENTS OF THIS PRODUCT. Doing so could cause personal injury and/or damage the unit voiding the manufacturer's warranty.

10. DO NOT operate your unit near or around flammable liquids or gases whether in or out of doors. An explosion and/or fire may result.
11. DO NOT WEAR loose clothing, scarfs, neck chains, unconfined long hair, and the like. Doing so could cause injury associated with objects being drawn into the rotating parts. Tie up long hair and fasten it, for example with a head scarf, cap, helmet, etc.
12. DO NOT refuel a running engine or an engine that is hot
13. Never allow children to use the blower vac.

2. Machine layout and items supplied (Fig. 1)

1. Rear Handle
2. Throttle Trigger
3. Throttle Lock
4. On/Off Switch
5. Front Handle
6. Exhaust Cover
7. Fuel Tank Window
8. Fuel Cap
9. Starter Handle
10. Air Filter Cover
11. Vacuum/Blower Tube
12. Choke Lever
13. Spark Plug Wire / Spark Plug
14. Vacuum/Blower Slide
15. Primer Bulb
16. Harness
17. Vacuum Bag
18. Speed Cleaner Head

3. Technical data

Engine	24 cc
Max. Air Velocity	ca. 145 km/h
Max. Air Volume	236 m ³ /h
Max. Engine Speed	7.800 ± 500 min ⁻¹
Collection Bag	55 Litre
Mulching Ratio	10:1
Fuel Capacity	650 ml
Weight	7.65 kg
Maximum Engine Performance	0.8 kW/1.1 HP
Sound power level L _{WA}	108 dB(A)
Sound pressure level at ear L _{pA}	95 dB(A)
Vibration a _{hv}	13.69 m/s ²

4. ASSEMBLY

● SUCTION TUBE (FIG. 1A + 1B)

1. Release the screws (A) and remove the screw (B). Insert blower tube (C) into the blower housing and replace screw (B). Tighten screws (A).
2. Insert speed cleaner head (D) to the tube (C).

● HARNESS INSTALLATION (FIG. 2)

Attach the 2 harness clips to the 2 links in the blower handle.

● VACUUM ATTACHMENT ASSEMBLY INSTRUCTIONS To install vacuum bag:

Pull the slide (A) forward and fit bag (B) into the vacuum housing. (See Fig. 3)

● FUEL

Use regular grade unleaded petrol mixed with 40:1 custom 2-cycle engine oil for best results.

WARNING: Never use straight petrol in your unit. This will cause permanent engine damage and void the manufacturer's warranty for that product. Never use a fuel mixture that has been stored for over 90 days.

WARNING: Use only Class I 2-stroke oil suitable for air-cooled engines.

● MIXING FUEL

Ensure mixing bottle cap is secured correctly and check that the gap does not leak, then. Mix the fuel with 2-stroke oil in a mixing bottle provided. Shake the container gently to ensure that it is properly mixed.

● FUEL AND LUBRICATION

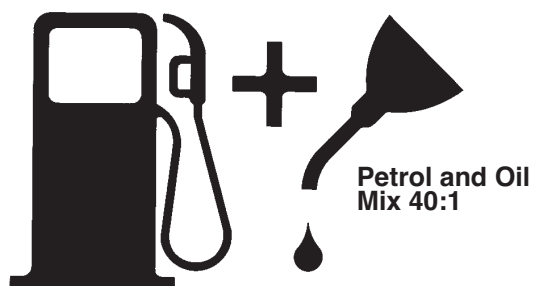

● RECOMMENDED FUELS

Some conventional petrols are being blended with oxygenates such as alcohol or an ether compound to meet clean air standards. Your engine is designed to operate satisfactorily on any fuel intended for automotive use including oxygenated fuels.

5. OPERATING INSTRUCTIONS

● STARTING A COLD ENGINE

Fill fuel tank with proper fuel and oil mixture. See Fuel and Lubrication.

Set unit on ground so that it rests on housing feet.

1. Pull the throttle trigger (A). (It will auto lock) Fig. 4A.
2. Prime the carburetor. Pump the primer bulb (C) 10 times (Fig. 4B).
3. Your unit is designed with a 2 position choke (D): START "I" and RUN "II". Move choke lever to START "I" position (Fig. 4C).
4. Grip handle firmly .
5. Pull starter handle out a short way until resistance is felt (approximately 100mm). Pull starter handle quickly and evenly until engine starts or attempts to run. Once engine starts, warm up at full throttle for 10 seconds and release throttle.
6. Push down the throttle lock (B), the throttle trigger (A) will go back to the normal position. (Fig. 4A)
7. Move the choke to RUN "II" position (Fig. 4E).

NOTE: If engine fails to start after repeated attempts, refer to Troubleshooting section.

NOTE: Always pull starter handle straight out. Pulling starter at an angle will cause rope to rub against the eyelet. This friction will cause the rope to fray and wear more quickly.

Always hold starter handle when rope retracts. Never allow rope to snap back from extended position. This could cause rope to snag or fray and also damage the starter assembly.

● STOPPING THE ENGINE

Emergency Stopping Procedure. When it is necessary to stop blower engine immediately, DEPRESS the switch to stop.

Normal Stopping Method. For normal stopping, push down the throttle lock, the throttle trigger will back to the normal position and allow engine to return to idle speed. Then DEPRESS and HOLD the "OFF" switch until the engine stops completely.

● STARTING A WARM ENGINE (Engine has been stopped for no more than 15-20 minutes)

Pull starter handle again. Engine should start with ONE or TWO pulls. If engine fails to start after 6 pulls, repeat steps 2 through 6 (see Starting a cold engine).

● BLOWER OPERATIONS (FIG. 5)

Your blower is designed to easily remove debris from patios, walkways, lawns, bushes, etc., and many hard to reach areas where debris may accumulate.

WARNING: Because of flying debris, always wear approved shielded safety glasses or face shield when operating blower. Before using your blower, review Safety Precautions in your User Manual, and all regulations for operation of the unit. These precautions and regulations are for your protection.

CAUTION: Hold the blower so that hot exhaust does not damage clothing and fumes are not inhaled by operator.

DO NOT operate the blower with other people or animals in the immediate vicinity. Allow a minimum of 30 feet (9 meters) between operator and other people or animals.

We recommend that a face mask be worn when operating blower in dusty areas.

Stand away from the debris, at a distance that will easily allow you to control the direction of blown debris. Never blow debris in direction of bystanders.

To control velocity of airstream, blower can be operated at any speed between idle and full throttle. Experience with the unit will help you determine the amount of airflow necessary for each application.

● VACUUM OPERATIONS

WARNING: NEVER OPERATE VACUUM WITHOUT VACUUM BAG PROPERLY ATTACHED, AS FLYING DEBRIS COULD CAUSE INJURY TO OPERATOR AND BYSTANDERS. ALWAYS MAKE SURE VACUUM BAG ZIPPER IS CLOSED BEFORE OPERATING UNIT.

Do not vacuum hot or burning materials (e.g. hot ash, glowing cigarettes) from outdoor fireplaces or barbecue pits. Always wait for these materials to be cool enough. Do not vacuum lighted smoking material such as discarded cigars or cigarettes. Do not operate unit near open flame.

CAUTION: This unit is designed to vacuum up debris such as leaves, small bits of paper, small twigs, weeds, grass

clippings, etc. Do not use this unit for any other purpose. Do not attempt to vacuum rocks, broken glass, bottles, tin cans or other such objects. Damage to impeller and unit as well as operator injury could result.

If vacuum tube is level with power unit horizontal, rocks or large objects may be drawn into tube, damaging the impeller.

To Operate Vacuum:

1. Follow correct starting procedures as explained in this manual.
2. Allow engine to return to idle. Put the shoulder harness on so the strap is over your right shoulder. Put the vacuum bag strap on so it is over your left shoulder.

CAUTION: Do not allow shoulder harness to cover, block, or come in contact with exhaust outlet during operation. The exhaust generates heat and could burn, melt, or damage harness strap.

3. Place your left hand on the top handle and right hand on side handle as shown (Fig. 6).
4. Swing unit side to side to vacuum debris.

CAUTION: To avoid clogging vacuum tube. DO NOT FORCE OR PLACE SUCTION TUBE INTO A PILE OF DEBRIS.

● VACUUM TUBE CLOGGING

To Unclog Vacuum Tube:

1. Turn engine "OFF". Promptly compress vacuum bag while it is still inflated, expelling air out of the suction tube. This reverse airflow is usually sufficient to dislodge most obstructions. If the obstruction cannot be cleared by compressing vacuum bag, follow this procedure:
2. Remove and inspect vacuum tubes.
3. Carefully clean out nozzle.
4. Reinstall vacuum tubes.

6. Maintenance

● AIR FILTER

CAUTION: NEVER operate blower without the air filter or dust and dirt will be sucked into the engine and damage it. The air filter must be kept clean. If it becomes damaged, install a new filter.

To Clean Air Filter(FIG .7A + 7B):

1. Remove 2 screws (A) holding air filter cover in place, remove cover (B) and lift filter (C) from cover
2. Wash filter in soap and water. **DO NOT USE PETROL!**
3. Air dry filter.
4. Reinstall air filter and air filter cover.

NOTE: Replace filter if frayed, torn, damaged or unable to be cleaned.

● CARBURETOR ADJUSTMENT

The carburetor was pre-set at the factory for optimum performance. If further adjustments are necessary, please take your unit to the nearest professional.

● SPARK PLUG (FIG .8)

1. Spark plug gap = .025 in. (0,6 mm)
2. Torque to 105 to 130 inch pounds (12 to 15 Nm). Connect spark plug boot.

● VACUUM BAG CLEANING

A dirty bag will obstruct airflow, thereby reducing vacuum efficiency.

To Clean Bag:

1. Detach vacuum bag from unit.
2. Open zipper and remove contents.
3. Turn bag INSIDE OUT and shake vigorously. This procedure should be performed on a regular basis.
4. Turn bag RIGHT SIDE OUT, close zipper and attach to unit.

NOTE: If vacuum bag is unusually dirty, it should be washed by hand in warm water with a mild detergent. Rinse thoroughly. Let dry before using.

7. Storage

7.1 STORING A UNIT

WARNING: Failure to follow these steps may cause varnish to form in the carburetor and difficult starting or permanent damage following storage.

1. Perform all the general maintenance recommended in the Maintenance Section of your User Manual.
2. Clean outside surface of unit.
3. Drain fuel from the fuel tank.
4. After fuel is drained, start engine.
5. Run engine at idle until unit stops. This will purge the carburetor of fuel.
6. Allow engine to cool (approx. 5 minutes).
7. Using a spark plug wrench, remove the spark plug.
8. Pour 1 teaspoon of clean 2-cycle oil into the combustion chamber (Fig. 9). Pull starter handle slowly several times to coat internal components. Replace spark plug.
9. Store unit in a cool, dry place away from any source of ignition such as an oil burner, water heater, etc.

7.2 REMOVING A UNIT FROM STORAGE

1. Remove spark plug.
2. Pull starter handle briskly to clear excess oil from combustion chamber.
3. Clean and gap spark plug or install a new spark plug with proper gap.
4. Prepare unit for operation.
5. Fill fuel tank with proper fuel / oil mixture. See Fuel and Lubrication Section.

8. Ordering replacement parts

Please quote the following data when ordering replacement parts:

- Type of machine
- Article number of the machine
- Identification number of the machine
- Replacement part number of the part required

For our latest prices and information please go to www.isc-gmbh.info

Helpline Numbers:

UK: 0151 649 1500

IRE: 189 094 6244

9. TROUBLE SHOOTING THE ENGINE

PROBLEM	PROBABLE CAUSE	CORRECTIVE ACTION
Unit won't start or starts but will not run.	Incorrect starting procedures.	Follow instructions in the User Manual.
	Incorrect carburetor mixture adjustment setting.	Have carburetor adjusted by an Authorized Service Center.
	Fouled spark plug	Clean / gap or replace plug.
	Fuel filter plugged.	Replace fuel filter.
	Debris bag mounting not fitted correctly	Check the debris bag mounting
Unit starts, but engine has low power.	Incorrect lever position on choke.	Move to RUN position.
	Dirty air filter.	Remove, clean and reinstall filter.
	Incorrect carburetor mixture adjustment setting.	Have carburetor adjusted by an Authorized Service Center.
Engine hesitates. No power under load.	Incorrect carburetor mixture adjustment setting.	Have carburetor adjusted by an Authorized Service Center.
Runs erratically.	Incorrectly gapped spark plug.	Clean / gap or replace plug.
Smokes excessively.	Incorrect carburetor mixture adjustment setting.	Have carburetor adjusted by an Authorized Service Center.
	Incorrect fuel mixture.	Use properly mixed fuel (40:1 mixture).

10. Starting procedure

Petrol Engine Starting Procedure / Check List

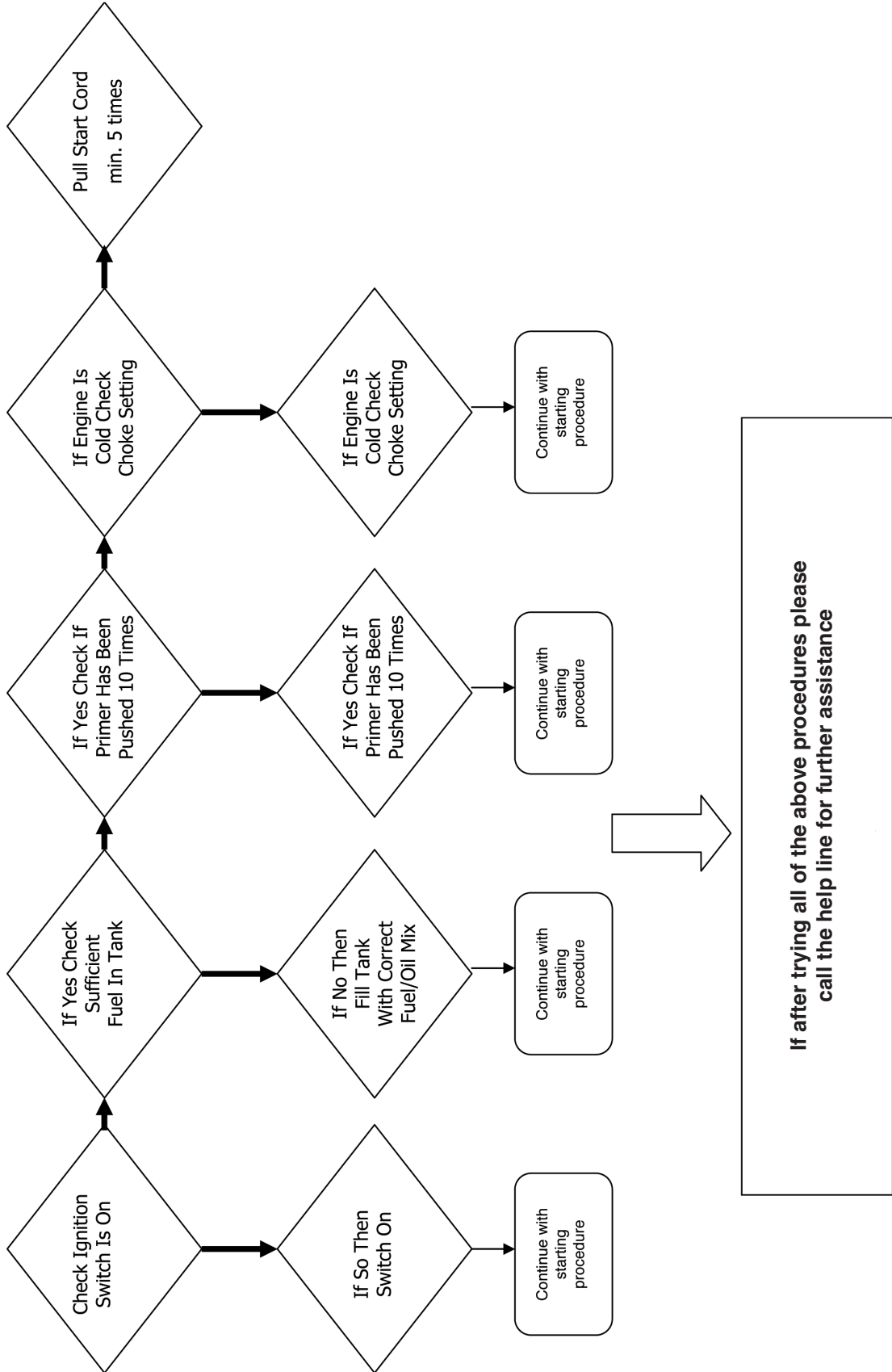



Konformitätserklärung

ISC-GmbH · Eschenstraße 6 · D-94405 Landau/Isar

- D** erklärt folgende Konformität gemäß EU-Richtlinie und Normen für Artikel
- GB** declares conformity with the EU Directive and standards marked below for the article
- F** déclare la conformité suivante selon la directive CE et les normes concernant l'article
- NL** verklaart de volgende conformiteit in overeenstemming met de EU-richtlijn en normen voor het artikel
- E** declara la siguiente conformidad a tenor de la directiva y normas de la UE para el artículo
- P** declara a seguinte conformidade de acordo com a directiva CE e normas para o artigo
- S** förklarar följande överensstämmelse enl. EU-direktiv och standarder för artikeln
- FIN** ilmoittaa seuraavaa Euroopan unionin direktiivien ja normien mukaista yhdenmukaisuutta tuotteelle
- N** erklærer herved følgende samsvar med EU-direktiv og standarder for artikkel
- RUS** заявляет о соответствии товара
- HR** izjavljuje sljedeću uskladenost s odredbama i normama EU za artikl.
- RO** declară următoarea conformitate cu linia directoare CE și normele valabile pentru articolul.
- TR** ürün ile ilgili olarak AB Yönetmelikleri ve Normları gereğince aşağıdaki uygunluk açıklama sunar.
- GR** δηλώνει την ακόλουθη συμφωνία σύμφωνα με την Οδηγία ΕΕ και τα πρότυπα για το προϊόν

- I** dichiara la seguente conformità secondo la direttiva UE e le norme per l'articolo
- DK** attesterer følgende overensstemmelse i henhold til EU-direktiv og standarder for produkt
- CZ** prohlašuje následující shodu podle směrnice EU a norem pro výrobek.
- H** a következő konformitást jelenti ki a termékerek vonatkozó EU-irányvonalak és normák szerint
- SLU** pojasnjuje sledečo skladnost po smernici EU in normah za artikel.
- PL** deklaruje zgodność wymienionego poniżej artykułu z następującymi normami na podstawie dyrektywy WE.
- SK** vydáva nasledujúce prehlásenie o zhode podľa smernice EU a noriem pre výrobok.
- BG** декларира следното съответствие съгласно директивите и нормите на ЕС за продукта.
- UKR** заявляє про відповідність згідно з Директивою ЄС та стандартами, чинними для даного товару
- EE** deklareerib vastavuse järgnevalele EL direktiivi dele ja normidele
- LT** deklaruoja atitiktį pagal ES direktyvas ir normas
- RS** izjavljuje sledeći konformitet u skladu s odredbom EZ i normama za artikl
- LV** Atbilstības sertifikāts apliecina zemāk minēto preču atbilstību ES direktīvām un standartiem
- IS** Samræmisýfirlýsing staðfestir eftirfarandi samræmi samkvæmt reglum Evfrópubandalagsins og stöðlum fyrir vörur

Petrol blower vac SPJBV 3200

- | | |
|---|--|
| <input checked="" type="checkbox"/> 98/37/EG | <input type="checkbox"/> 87/404/EWG |
| <input type="checkbox"/> 2006/95/EG | <input type="checkbox"/> R&TTED 1999/5/EG |
| <input type="checkbox"/> 97/23/EG | <input checked="" type="checkbox"/> 2000/14/EG: $L_{WM} = 107 \text{ dB}; L_{WA} = 108 \text{ dB}$
$P = 0.8 \text{ kW}$ |
| <input checked="" type="checkbox"/> 2004/108/EG | <input type="checkbox"/> 95/54/EG: |
| <input type="checkbox"/> 90/396/EWG | <input checked="" type="checkbox"/> 97/68/EG: $e4^*97/68SH2G3^*2004/26^*0109^*04$ |
| <input type="checkbox"/> 89/686/EWG | |

EN ISO 14982; KBV V

Landau/Isar, den 19.09.2007

Wolchseggartner
General-Manager

Wimmer
Product-Management

Art.-Nr.: 34.360.05 I.-Nr.: 01027
Subject to change without notice

Archivierung: 3436000-02-4160270

GUARANTEE CERTIFICATE

Dear Customer,

All of our products undergo strict quality checks to ensure that they reach you in perfect condition. In the unlikely event that your device develops a fault, please contact our service department at the address shown on this guarantee card. Of course, if you would prefer to call us then we are also happy to offer our assistance under the service number printed below. Please note the following terms under which guarantee claims can be made:

1. These guarantee terms cover additional guarantee rights and do not affect your statutory warranty rights. We do not charge you for this guarantee.
2. Our guarantee only covers problems caused by material or manufacturing defects, and it is restricted to the rectification of these defects or replacement of the device. Please note that our devices have not been designed for use in commercial, trade or industrial applications. Consequently, the guarantee is invalidated if the equipment is used in commercial, trade or industrial applications or for other equivalent activities. The following are also excluded from our guarantee: compensation for transport damage, damage caused by failure to comply with the installation/assembly instructions or damage caused by unprofessional installation, failure to comply with the operating instructions (e.g. connection to the wrong mains voltage or current type), misuse or inappropriate use (such as overloading of the device or use of non-approved tools or accessories), failure to comply with the maintenance and safety regulations, ingress of foreign bodies into the device (e.g. sand, stones or dust), effects of force or external influences (e.g. damage caused by the device being dropped) and normal wear resulting from proper operation of the device.

The guarantee is rendered null and void if any attempt is made to tamper with the device.

3. The guarantee is valid for a period of 2 years starting from the purchase date of the device. Guarantee claims should be submitted before the end of the guarantee period within two weeks of the defect being noticed. No guarantee claims will be accepted after the end of the guarantee period. The original guarantee period remains applicable to the device even if repairs are carried out or parts are replaced. In such cases, the work performed or parts fitted will not result in an extension of the guarantee period, and no new guarantee will become active for the work performed or parts fitted. This also applies when an on-site service is used.

Of course, we are also happy offer a chargeable repair service for any defects which are not covered by the scope of this guarantee or for units which are no longer covered. To take advantage of this service, please send the device to our service address.

Argos Ltd
489-499 Avebury Boulevard
Saxon Gate West
Central Milton Keynes
MK9 2NW

Helpline Numbers:

UK: 0151 649 1500

IRE: 189 094 6244



The reprinting or reproduction by any other means, in whole or in part, of documentation and papers accompanying products is permitted only with the express consent of ISC GmbH.

© Technical specifications subject to change

