

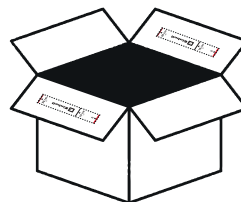

Einhell



FREELEXO CAM 500

D: Lieferumfang · GB: Scope of delivery · F: Contenu de la livraison · I: Dotazione di forniture · E: Alcance de entrega
 NL: Leveringsomvang · FIN: Toimituslaajuus · S: Leverans · EE: Tarne ulatus · PL: Zakres dostawy · P: Escopo de entrega
 DK/N: Leveringsomfang · CZ: Rozsah dodávky · SK: Rozsah doručenia · H: Szállítási terjedelem · SLO: Obseg dobave
 RO: Cuprinsul livrării · GR: Συμπερααδιόδομενα · HR/BIH: Sadržaj isporuke · RS: Isporuka · TR: Teslimat kapsamı

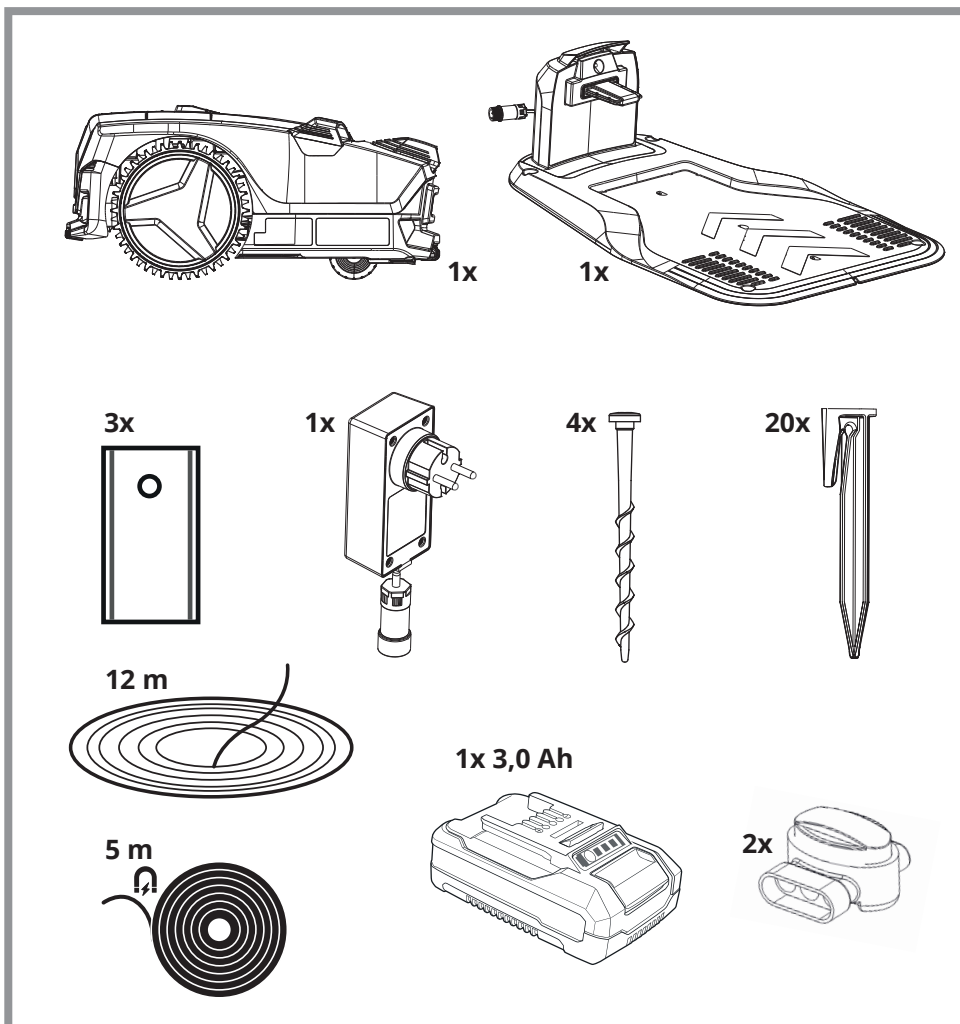

Art.-Nr.: 34.139.91

I.-Nr.: 21022

EH 11/2022 (01)