



**2200W**

# **SLIDING MITRE SAW**



**INSTRUCTION MANUAL**

**MODEL NUMBER TT-SM 2534 DUAL**

**AFTER SALES SUPPORT**

**TEL: 1300 922 271**

**EMAIL: [service.australia@einhell.com](mailto:service.australia@einhell.com)**

** N26704**

# Sliding Mitre Saw

## What your 3 year warranty means

Great care has gone into the manufacture of this product and it should therefore provide you with years of good service when used properly. In the event of product failure within its intended use over the course of the first 3 years after the date of purchase, we will remedy the problem as quickly as possible once it has been brought to our attention. In the unlikely event of such an occurrence, or if you require any information about the product, please contact us via our after sales support services, details of which can be found in this manual and on the product itself.

## Welcome Section

Congratulations on choosing to buy a TAURUS TITANIUM® product. All products brought to you by TAURUS TITANIUM® are manufactured to the highest standards of performance and safety, and, as part of our philosophy of customer service and satisfaction, are backed by our comprehensive 3 Year Warranty.

We hope you will enjoy using your purchase for many years to come.

## Table of Contents

1. General Safety Rules	08
2. Special Safety Rules	09
3. Layout	11
4. Items Supplied	12
5. Intended Use	12
6. Technical Data	12
7. Before Starting the Equipment	13
8. Functions	14
9. Replacing the Power Cable	15
10. Cleaning, Maintenance & Ordering of Spare Parts	16
11. Storage	16
12. Disposal & Recycling	16

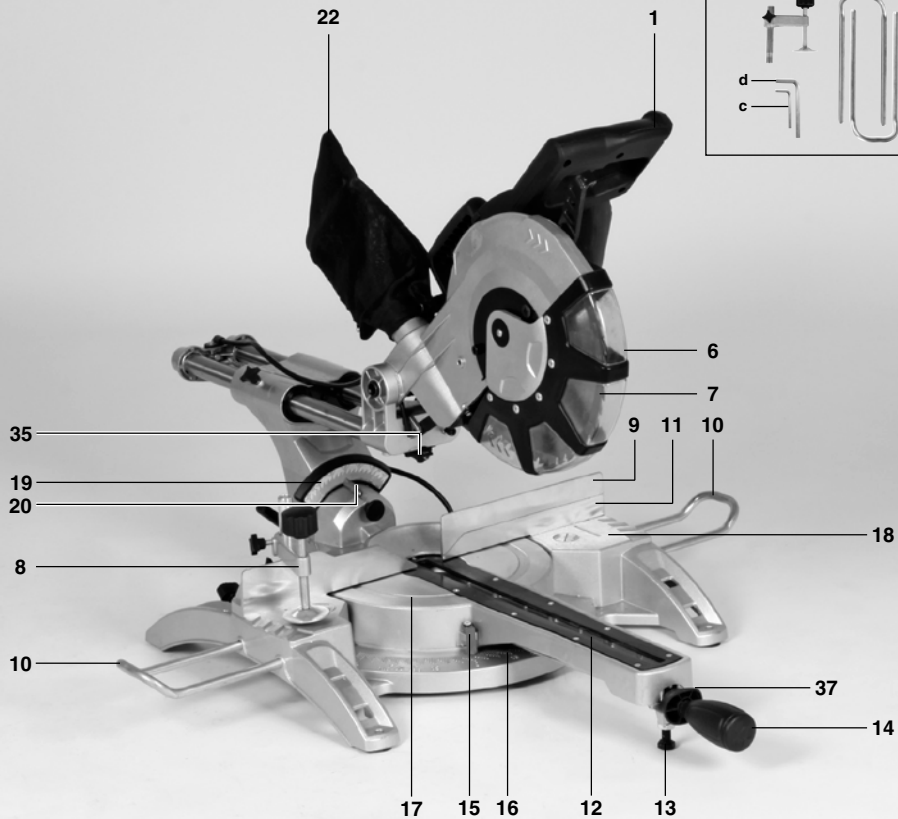
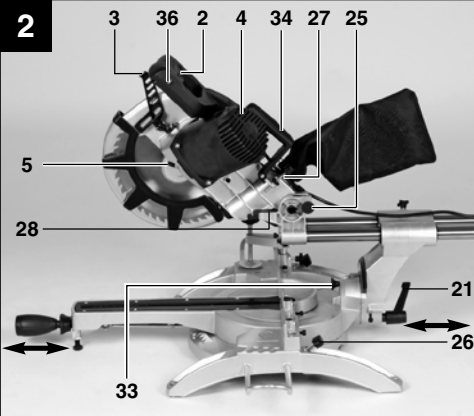
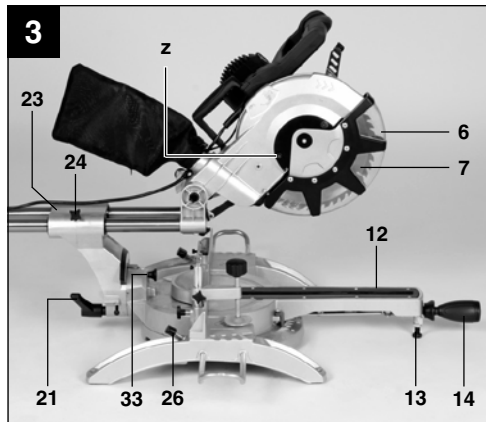

**1****2****3****AFTER SALES SUPPORT**

1300 922 271



service.australia@einhell.com

**3****MODEL NUMBER: TT-SM 2534 DUAL, 10/13**

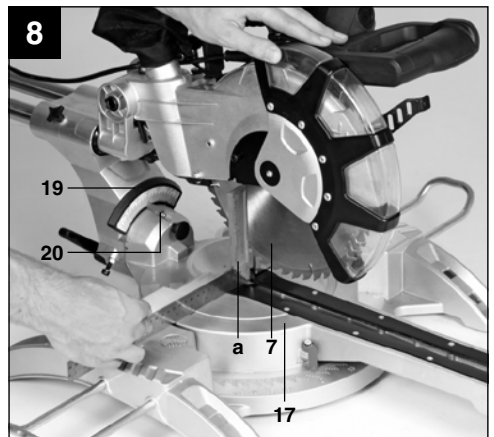
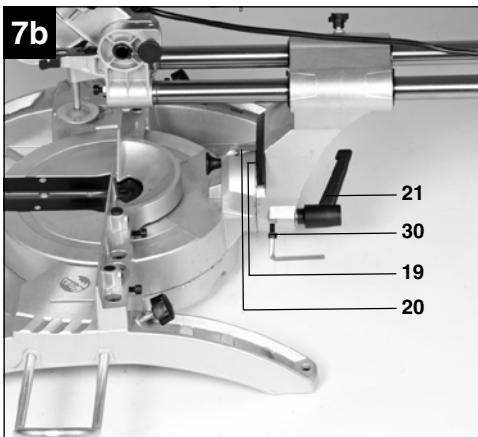
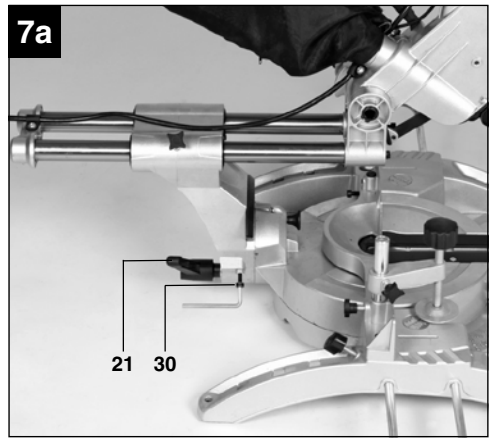
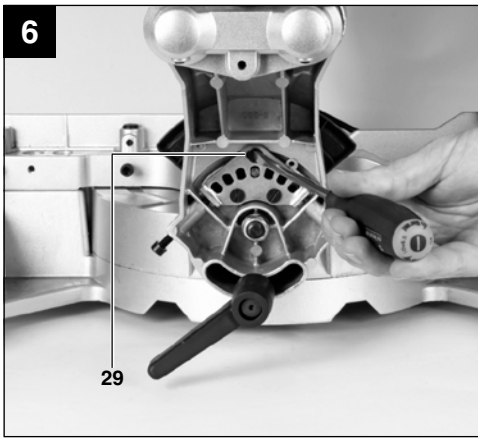
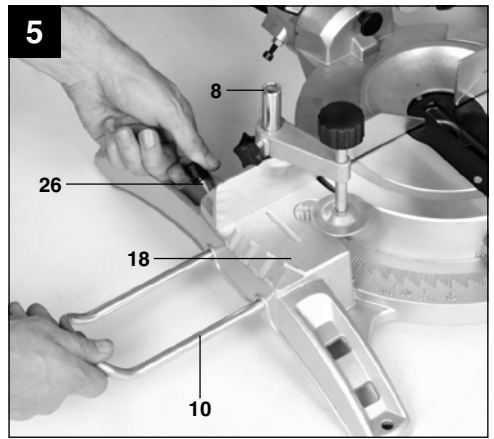
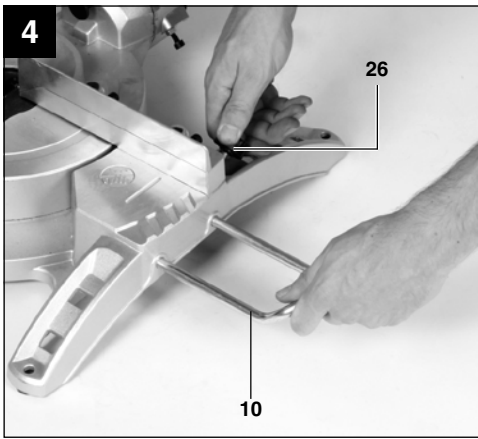

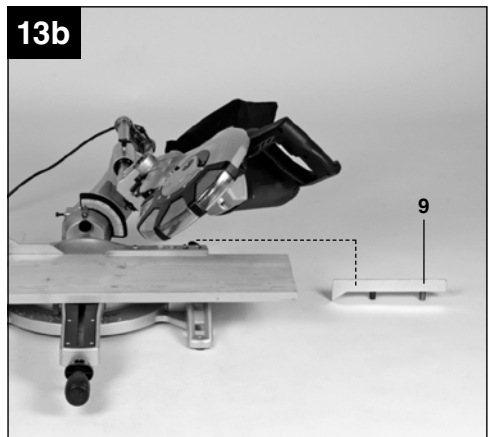
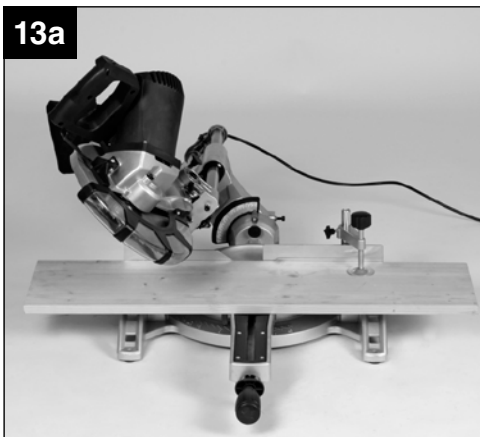
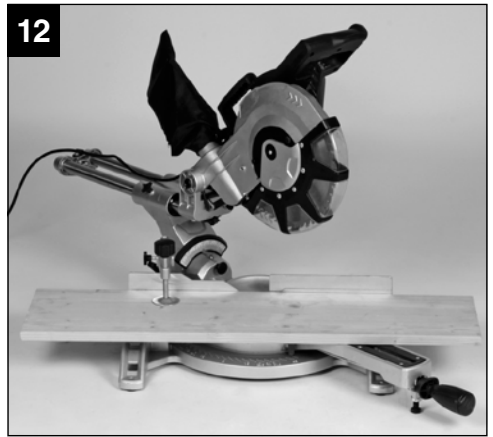
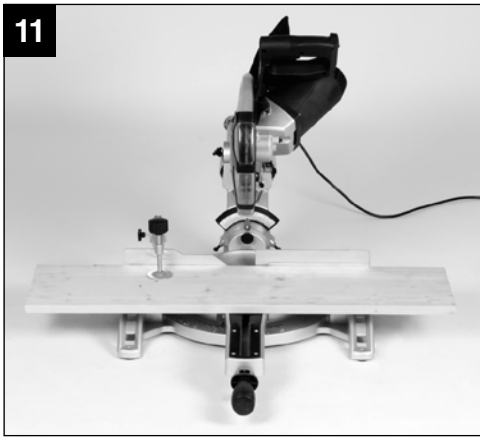
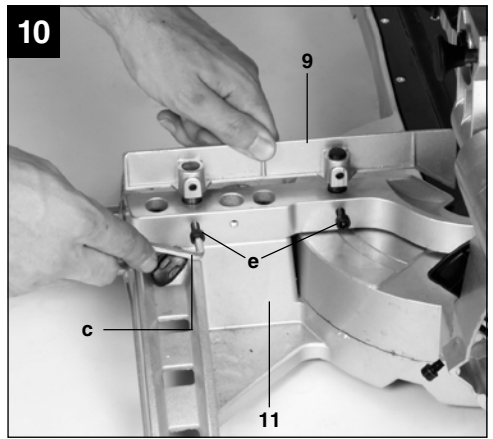
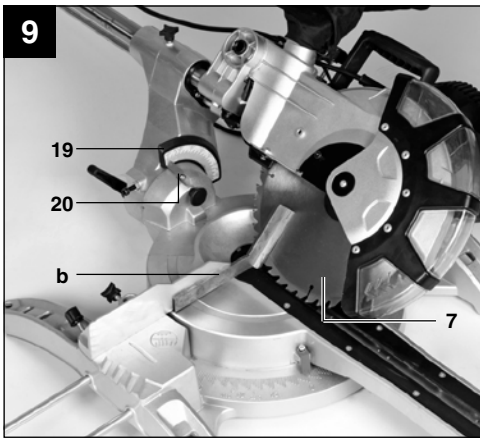

14a

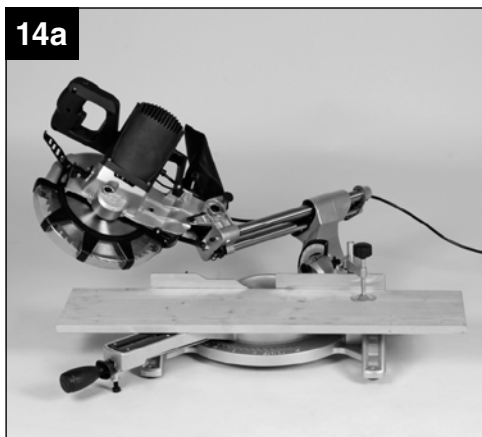

14b

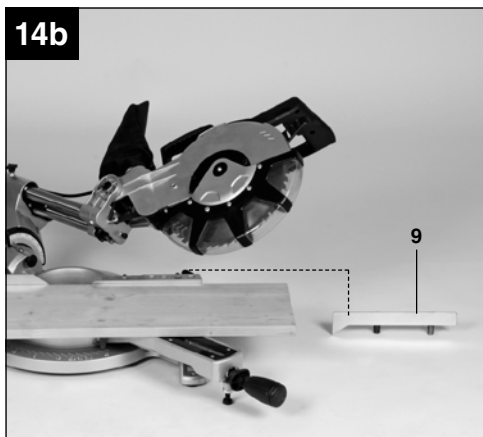

15

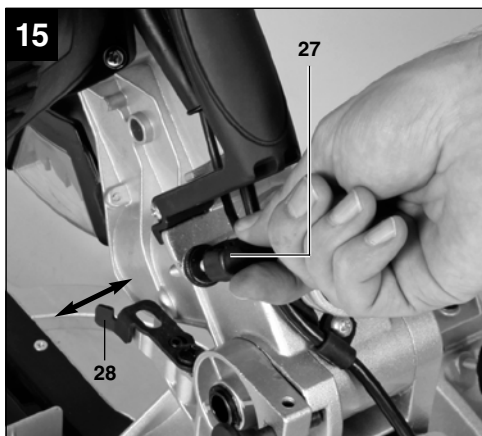

16

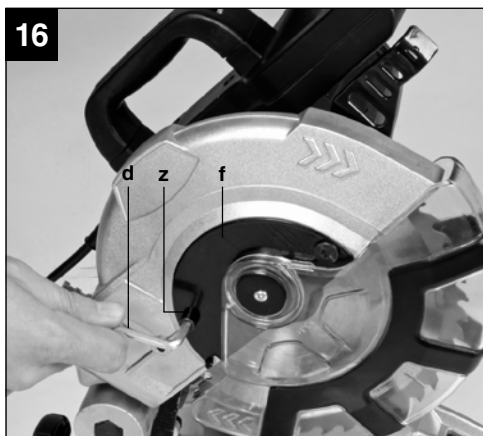

17



18

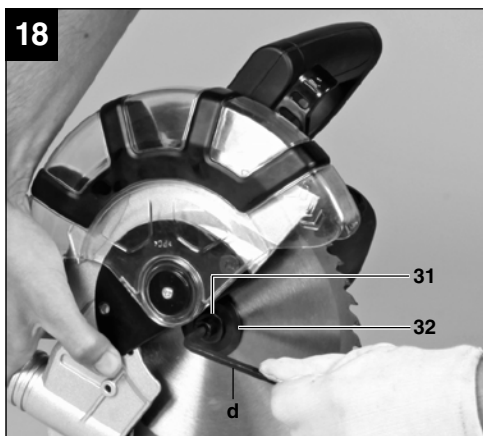

AFTER SALES SUPPORT



1300 922 271



service.australia@einhell.com



**Caution.**  
Read the operating instructions to reduce the risk of injury.



**Wear ear-muffs.**  
The impact of noise can cause damage to hearing.



**Wear safety goggles.**  
Sparks generated during working or splinters, chips and dust emitted



**Wear a breathing mask.**  
Dust which is injurious to health can be generated when working on wood and other materials. Never use the device to work



# 1. GENERAL SAFETY RULES

**WARNING!** Read all instructions. Failure to follow all instructions listed below may result in electric shock, fire and/or serious injury. The term "power tool" in all of the warnings listed below refers to your mains-operated (corded) power tool or battery-operated (cordless) power tool.

## SAVE THESE INSTRUCTIONS

### CAUTION

#### Read all safety regulations and instructions.

Any errors made in following the safety regulations and instructions may result in an electric shock, fire and/or serious injury.

Keep all safety regulations and instructions in a safe place for future use.

#### 1. Work area

- Keep work area clean and well lit.** Cluttered and dark areas invite accidents.
- Do not operate power tools in explosive atmospheres, such as in the presence of flammable liquids, gases or dust.** Power tools create sparks which may ignite the dust or fumes.
- Keep children and bystanders away while operating a power tool.** Distractions can cause you to lose control.

#### 2. Electrical safety

- Power tools plugs must match the outlet. Never modify the plug in any way.** Do not use any adapter plugs with earthed (grounded) power tool. Unmodified plugs and matching outlets will reduce risk of electric shock.
- Avoid body contact with earthed or grounded surfaces such as pipes, radiators, ranges and refrigerators.** There is an increased risk of electric shock if your body is earthed or grounded.
- Do not expose power tools to rain or wet conditions.** Water entering a power tool will increase the risk of electric shock.
- Do not abuse the cord. Never use the cord for carrying, pulling or unplugging the power tool. Keep cord away from heat, oil, sharp edges or moving parts.** Damaged or entangled cords increase the risk of electric shock.
- When operating a power tool outdoors, use an extension cord suitable for outdoor use.** Use of a cord suitable for outdoor use reduces the risk of electric shock.

#### 3. Personal safety

- Stay alert, watch what you are doing and use common sense when operating a power tool. Do not use a power tool while you are tired or under the influence of drugs, alcohol or medication.** A moment of inattention while operating power tools may result in serious personal injury.

- Use safety equipment. Always wear eye protection.** Safety equipment such as dust mask, non-skid safety shoes, hard hat, or hearing protection used for appropriate conditions will reduce personal injuries.
- Avoid accidental starting. Ensure the switch is in the off-position before plugging in.** Carrying power tools with your finger on the switch or plugging in power tools that have the switch on invites accidents.
- Remove any adjusting key or wrench before turning the power tool on.** A wrench or a key left attached to rotating part of the power tool may result in personal injury.
- Do not overreach. Keep proper footing and balance at all times.** This enables better control of the power tool in unexpected situations.
- Dress properly. Do not wear loose clothing or jewellery. Keep your hair, clothing and gloves away from moving parts.** Loose clothes, jewellery or long hair can be caught in moving parts.
- If devices are provided for the connection of dust extraction and collection facilities, ensure these are connected and properly used.** Use of these devices can reduce dust-related hazards.

#### 4. Power tool use and care

- Do not force the power tool. Use the correct power tool for your application.** The correct power tool will do the job better and safer at the rate for which it was designed.
- Do not use the power tool if the switch does not turn it on and off.** Any power tool that cannot be controlled with the switch is dangerous and must be repaired.
- Disconnect the plug from the power source and/or the battery pack from the power tool before making any adjustments, changing accessories, or storing power tools.** Such preventive safety measures reduce the risk of starting the power tool accidentally.
- Store idle power tools out of the reach of children and do not allow persons unfamiliar with the power tool or these instructions to operate the power tool.** Power tools are dangerous in the hands of untrained users.
- Maintain power tools. Check for misalignment or binding of moving parts, breakage of parts and any other condition that may affect the power tool's operation. If damaged, have the power tool repaired before use.** Many accidents are caused by poorly maintained power tools.
- Keep cutting tools sharp and clean.** Properly maintained cutting tools with sharp cutting edges are less likely to bind and are easier to control.
- Use the power tool, accessories and tool bits etc. in accordance with these instructions and in the manner intended for the particular type of power tool, taking into account**

## AFTER SALES SUPPORT



1300 922 271



service.australia@einhell.com



**the working conditions and the work to be performed.** Use of the power tool for operations different from those intended could result in a hazardous situation.

## 5. Service

- a. **Have your power tool serviced by a qualified repair person using only identical replacement parts.** This will ensure that the safety of the power tool is maintained.

## 6. Recommendation

We recommend that the tool always be supplied via residual current device with a rated residual current of 30 mA or less.

# 2. SPECIAL SAFETY RULES

## 1. Safety Actions

- Blades that are deformed or cracked must not be used.
- If the table insert is worn, replace it.
- Use only blades which are recommended by the manufacturer and comply with EN 847-1.
- Make sure that the chosen blade is suitable for the material that is to be cut.
- If necessary, wear suitable personal protection equipment. This could consist of:
  - Ear plugs to prevent the risk of damaging your hearing;
  - A breathing mask to avoid the risk of inhaling hazardous dust.
  - Always wear gloves when handling saw blades and rough materials. Whenever practicable, saw blades must be carried in a container.
- The following can have an influence on dust development:
  - Worn, damaged or cracked saw blades
  - Recommended capacity of the vacuum extraction system: 20 m/s
  - Proper guidance of the workpiece
- Blades made of high-alloy high-speed steel (HSS) must not be used.
- Keep the push stick or handle for a push block at the machine at all times, even when you are not using them.

## 2. Maintenance and Service

- The following conditions can have an influence on noise impact on the operator:
  - Type of sawblade (e.g. saw blades designed to reduce noise development)
  - Material of the workpiece
  - The force with which the workpiece is pushed against the sawblade
- Faults on the machine or its guards, safety devices and blade must be reported to the person in charge as soon as they are discovered.

- Have your tool repaired by an expert
  - This electric appliance must be serviced and repaired in accordance with the relevant safety rules. Repairing of electric appliances may be carried out only by experts otherwise it may cause considerable danger for the user.

## 3. Safe Operation

- Select a suitable blade for the material you wish to saw.
- Never use the drag, crosscut and mitre saw to cut any materials other than those specified by the manufacturer.
- Use only the transport devices to move the machine. Never use the guards for handling or moving the machine.
- Use the saw only if it is in perfect condition and properly maintained.
- When cutting mitres, make sure that the device for swiveling the arm is fastened securely.
- The floor around the machine must be level, clean and free of loose particles, such as chips and cutting residues.
- Make sure the workplace and the room are sufficiently illuminated.
- The operator must receive proper training in the use, adjustment and operation of the machine.
- Only use properly sharpened saw blades. Do not exceed the maximum speed specified on the blade.
- Be sure to only use spacers and spindle rings specified by the manufacturer as suitable for the intended purpose.
- If the machine is equipped with a laser, this laser may not be replaced by a different type of laser. Repairs may only be carried out by the manufacturer of the laser or one of his authorized agents.
- Do not remove any cutting residues or other parts of workpieces from the cutting zone while the machine is running and the saw unit is not at rest.
- Make sure that the machine is always secured on a workbench or a table if at all possible.
- Support long workpieces (e.g. with a roller table) to prevent them sagging at the end of a cut.

## 4. Additional Instructions

- Always pull the plug out of the power socket before adjusting or servicing the machine.
- Give these safety regulations to all persons who work on the machine.
- Do not use this saw to cut fire wood.
- Caution! Hands and fingers may be injured on the rotating saw blade.
- Before you use the machine for the first time, check that the voltage marked on the rating plate is the same as your mains voltage.
- If you need to use an extension cable, make sure its conductor cross-section is big enough for the saw's power consumption. Minimum cross section: 1.5 mm<sup>2</sup>.
- If you use a cable reel, the complete cable has to be



pulled off the reel.

- Never carry the saw by its cable.
- Do not leave the saw in the rain and never use it in damp or wet conditions.
- Provide good lighting.
- Never saw near combustible liquids or gases.
- Wear suitable work clothes! Loose garments or jewellery may become caught up in the rotating saw blade.
- Operators have to be at least 18 years of age. Trainees of at least 16 years of age are allowed to use the machine under supervision.
- Keep children away from the machine when it is connected to the power supply.
- Check the power cable. Never use a faulty or damaged power cable.
- Keep your workplace clean of wood scrap and any unnecessary objects.
- Persons working on the machine should not be distracted.
- Note the direction of rotation of the motor and saw blade.
- After you have switched off the motor, never slow down the saw blade by applying pressure to its side.
- Fit only blades which are well sharpened and have no cracks or deformations.
- The machine is to be operated only with tools which conform with EN 847-1.
- Faulty saw blades have to be replaced immediately.
- Never use saw blades which do not comply with the data specified in this manual.
- Make sure that the arrow on the saw blade complies with the arrow marked on the machine.
- Make certain that the saw blade does not touch the rotary table in any setting. To do so, pull out the power plug and tilt the saw blade by hand into the 45° position and the 90° position.  
If necessary, re-adjust the saw head as described in Section 7.3 and 7.4.
- It is imperative to make sure that all the devices used to cover the saw blade are in good working order.
- Never wedge the hinged guard hood in open position.
- Never dismantle the machines safety devices or put them out of operation.
- Damaged or faulty safety devices have to be replaced immediately.
- Never cut workpieces which are too small to hold securely in your hand.
- Do not place your hands in awkward positions where one or both may slip suddenly and touch the saw blade.
- When working with long workpieces, use an additional support (table, stand, etc.) to prevent the machine from tipping over.
- Always clamp workpieces with suitable devices. There must be no nails or other foreign bodies in that part of the workpiece you want to cut.
- Always stand to the side of the saw blade when working with the saw.
- Never load the machine so much that it cuts out.
- Always press the workpiece firmly against the table and the stop rail to prevent it from wobbling or twisting.
- Make sure that off-cuts can be removed from the side of the saw blade. If not, they may catch on the saw blade crown and be catapulted into the surrounding area.
- Never saw several workpieces simultaneously.
- Never remove loose splinters, chips or jammed pieces of wood when the saw blade is running.
- To rectify faults or remove jammed pieces of wood, always switch off the machine first. - Pull out the power plug!
- Conversions, adjustments, measurements and cleaning jobs are to be performed only when the motor is switched off. - Pull out the power plug!
- Before you switch on the machine, check that all wrenches and adjustment tools have been removed.
- When you leave your workplace, switch off the motor and pull out the power plug.
- Electric installation work, repairs and maintenance are to be carried out only by specialists.
- All guards and safety devices have to be refitted immediately after completion of any repairs or maintenance.
- It is imperative to observe the manufacturers safety, operating and maintenance instructions as well as the dimensions quoted in the technical data.
- It is imperative to observe the accident prevention regulations in force in your area as well as all other generally recognized rules of safety.
- Switch on the dust extraction system each time you use the machine.
- The machine may be used in closed rooms only in conjunction with a suitable vacuum extraction system.
- The circular cross-cut must be connected to a 240 V socket-outlet with a minimum 10 A fuse.
- Never use light-duty machines for heavy-duty work.
- Never use the cable for any purpose other than that for which it is intended!
- Adopt a firm standing position and keep your balance at all times.
- Check the tool for signs of damage!
- Before you carry on using the tool it is imperative to check that its safety devices and any slightly damaged parts are working properly and in the way intended.
- Check that the moving parts work properly and do not jam or whether any of the parts are damaged. All parts must be fitted correctly and satisfy all conditions for the tool to work properly.
- Unless otherwise stated in these instructions, damaged safety devices and parts must be repaired or replaced by experts in an approved specialist workshop.
- Have damaged switches replaced by a customer service workshop.
- This tool complies with the pertinent safety regulations. Repairs are to be carried out only by qualified electricians using original replacement parts. The user may suffer an accident if this condition is not observed.
- Pull out the power plug and twist the blade with

## AFTER SALES SUPPORT



1300 922 271



service.australia@einhell.com

your hand into the 45° and 90° positions in order to make sure that the blade does not touch the turntable in any position. If necessary, readjust the saw head.

- If the table insert is worn, replace it.
- Never use blades made of high-speed steel (HSS).
- When cutting mitres, make sure that the device for swiveling the arm is fastened securely.
- Be careful when working in vertical mode.
- **Caution:** Take extra care when making double mitre cuts!
- Do not overload your tool.
- Wear safety goggles.
- Use a dust mask when working on dusty jobs
- Check the tool cable/extension cable for damage.
- Always wear gloves when handling saw blades

### 5. Special Information about the Laser

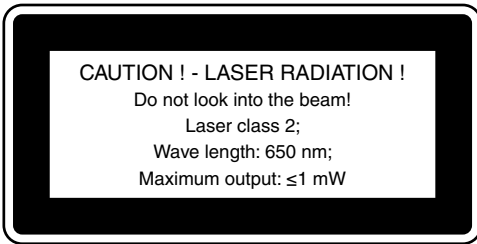

- Never look directly into the laser path.
- Never direct the laser beam at reflecting surfaces or persons or animals. Even a low output laser beam can inflict injury on the eye.
- **Caution:** It is vital to follow the work procedures described in these instructions. Using the equipment in any other way may result in hazardous exposure to laser radiation.
- Never open the laser module.
- It is prohibited to carry out any modifications to the laser to increase its power.
- The manufacturer cannot accept any liability for damage due to non-observance of the safety information.

### Important!

When using the equipment, a few safety precautions must be observed to avoid injuries and damage. Please read the complete operating instructions and safety information with due care. Keep these operating instructions in a safe place so that the information is available at all times. If you give the equipment to any other person, hand over these operating instructions and the safety information as well. We cannot accept any liability for damage or accidents which arise due to a failure to follow these instructions and the safety information.

### 3. LAYOUT

1. Handle
2. ON/OFF switch
3. Release lever
4. Machine head
5. Saw shaft lock
6. Adjustable blade guard
7. Saw blade
8. Clamping device
9. Removable fence
10. Workpiece support
11. Fixed fence
12. Table insert
13. Adjustable foot
14. Locking screw
15. Pointer
16. Scale
17. Turntable
18. Fixed saw table
19. Scale
20. Pointer
21. Locking screw
22. Sawdust bag
23. Slide guide
24. Slide lock screw
25. Fastening bolt
26. Locking screw for workpiece support
27. Knurled screw for cutting depth limiter
28. Stop for cutting depth limiter
29. Adjusting screw (precision adjustment for 90° straight cuts)
30. Adjusting screw (precision adjustment for 45° bevel cuts)
31. Flange bolt
32. Outer flange
33. Button
34. Transport handle
35. Laser
36. ON/OFF switch for laser
37. Release device



## 4. ITEMS SUPPLIED (Figs. 1-3)

- Open the packaging and take out the equipment with care.
- Remove the packaging material and any packaging and/or transportation braces (if available).
- Check to see if all items are supplied.
- Inspect the equipment and accessories for transport damage.
- If possible, please keep the packaging until the end of the guarantee period.

### Important!

The equipment and packaging material are not toys. Do not let children play with plastic bags, foils or small parts.

There is a danger of swallowing or suffocating!

- 1 x Sliding Mitre Saw
- 3 x Saw blades (1 x mounted, 2 x additional blades)
- 1 x Clamping device (8)
- 2 x Workpiece support (10)
- 1 x Sawdust bag (22)
- 2 x Allen key (c, d)
- 1 x Instruction Manual
- 1 x Quick Start Guide
- 1 x Warranty card
- 1 x Warranty sticker

## 5. INTENDED USE

The sliding mitre saw is designed to cut wood and plastic respectively of the machine's size. The saw is not designed for cutting firewood.

The equipment is to be used only for its prescribed purpose. Any other use is deemed to be a case of misuse. The user/operator and not the manufacturer will be liable for any damage or injuries of any kind caused as a result of this.

Please note that our equipment has not been designed for use in commercial, trade or industrial applications. Our warranty will be voided if the equipment is used in commercial, trade or industrial businesses or for equivalent purposes.

The equipment is to be operated only with suitable saw blades. It is prohibited to use any type of cutting off wheel.

To use the equipment properly you must also observe the safety information, the assembly instructions and the operating instructions to be found in this manual. All persons who use and service the equipment have to be acquainted with these operating instructions and must be informed about the equipment's potential hazards. It is also imperative to observe the accident prevention regulations in force in your area. The same applies for the general rules of health and safety at work.

The manufacturer will not be liable for any changes made to the equipment nor for any damage resulting from such changes. Even when the equipment is used as prescribed it is still impossible to eliminate certain residual risk factors. The following hazards may arise in connection with the machine's construction and design:

- Contact with the saw blade in the uncovered saw zone.
- Reaching into the running saw blade (cut injuries).
- Kick-back of workpieces and parts of workpieces.
- Saw blade fracturing.
- Catapulting of faulty carbide tips from the saw blade.
- Damage to hearing if ear-muffs are not used as necessary.
- Harmful emissions of wood dust when used in closed rooms.

## 6. TECHNICAL DATA

AC motor:	240 V ~ 50Hz
Power:	2100 W S1 / 2200 W S6 25%
Idle speed n <sub>0</sub> :	4000 min <sup>-1</sup>
Carbide saw blade (mounted):	ø 250 x ø 30 x 3.0 mm (48T)
Carbide saw blade (spare):	ø 250 x ø 30 x 3.2 mm (48T)
Swiveling range:	-45° / 0° / +45°
Mitre cut to the left:	0° to 45°
Mitre cut to the right:	0° to 45°
Saw width at 90°:	340 x 75 mm
Saw width at 45°:	240 x 75 mm
Saw width at 2 x 45° (compound mitre cut left):	240 x 42 mm
Saw width at 2 x 45° (compound mitre cut right):	240 x 25 mm
Weight: approx.	16 kg
Laser class:	2
Wavelength of laser:	650 nm
Laser output:	≤ 1 mW

Operating mode S6 25%: Continuous operation with idling (cycle time 10 minutes). To ensure that the motor does not become excessively hot it may only be operated for 25% of the cycle at the specified rating and must then be allowed to idle for 75% of the cycle.



## Sound and vibration

Sound and vibration values were measured in accordance with EN 61029.

$L_{pA}$ sound pressure level	95 dB(A)
$K_{pA}$ uncertainty	3 dB
$L_{WA}$ sound power level	108 dB(A)
$K_{WA}$ uncertainty:	3 dB

### Wear ear-muffs.

The impact of noise can cause damage to hearing.

Total vibration values (vector sum of three directions) determined in accordance with EN 61029.

Vibration emission value  $a_h = 4.58 \text{ m/s}^2$   
K uncertainty =  $1.5 \text{ m/s}^2$

### Additional information for electric power tools

#### Warning!

The specified vibration value was established in accordance with a standardized testing method. It may change according to how the electric equipment is used and may exceed the specified value in exceptional circumstances.

The specified vibration value can be used to compare the equipment with another electric power tools.

The specified vibration value can be used for initial assessment of a harmful effect.

#### Reduce noise generation and vibration to a minimum!

- Use only equipment that is in perfect condition.
- Maintain and clean the equipment regularly.
- Adopt your way of working to the equipment.
- Do not overload the equipment.
- Have the equipment checked if necessary.
- Switch off the equipment when not in use.

#### Residual risks

Even if you use this electric power tool in accordance to instructions, certain residual risks cannot be eliminated. The following hazards may arise in connection with the equipment's construction and layout:

1. Lung damage if no suitable protective dust mask is applied.
2. Damage to hearing if no suitable ear protection is applied.
3. Health damage caused by hand-arm vibrations if the equipment is used over a longer period or is not properly guided and maintained.

## 7. BEFORE STARTING THE EQUIPMENT

### 7.1 General Information

- The equipment must be set up where it can stand securely, i.e. it should be bolted to a workbench, a universal base frame or similar.
- All covers and safety devices have to be properly fitted before the equipment is switched on.
- It must be possible for the blade to run freely.
- When working with wood that has been processed before, watch out for foreign bodies such as nails or screws, etc.
- Before you actuate the On/Off switch, make sure that the saw blade is correctly fitted and that the equipment's moving parts run smoothly.
- Check that the voltage on the rating plate is the same as your supply voltage before you connect the equipment to the power supply.
- Pull out the power plug before carrying out any assembly and adjustment work.

### 7.2 Assembling the saw (Fig. 1-5)

- To adjust the turntable (17), turn the locking screw (14) anti-clockwise by approx. 2 turns, which frees the turntable (17).
- Pull the release device (37) and turn the turntable (17) and scale pointer (15) to the desired angular setting on the dial (16) and lock into place with the locking screw (14). The saw has locking positions at angles of  $-45^\circ$ ,  $-31.6^\circ$ ,  $-22.5^\circ$ ,  $-15^\circ$ ,  $0^\circ$ ,  $15^\circ$ ,  $22.5^\circ$ ,  $31.6^\circ$  and  $45^\circ$ , at which the turntable (17) audibly clicks into position.
- To release the saw from its position at the bottom, pull the fastening bolt (25) out of the motor mounting while pressing down lightly on the machine head (4). Turn the fastening bolt (25) through  $90^\circ$  before releasing it, so that the saw remains unlocked.
- Swing the machine head (4) up until the release lever (3) latches into place.
- The clamping device (8) can be fitted on the left or right of the fixed saw table (18).
- Undo the locking screws for the workpiece support (26).
- Mount the workpiece support (10) on the fixed saw table (18) and tighten the appropriate locking screw (26) (Figs. 4, 5).
- Mount the second workpiece support (10) on the opposite side of the saw and secure with the appropriate locking screw (26).
- When the locking screw (21) is loosened, you can tilt the machine head (4) to the left by up to  $45^\circ$ .
- To ensure that the saw is standing securely, adjust the adjustable foot (13) by turning it in such a way that the saw stands in a horizontal and firm position.

## AFTER SALES SUPPORT



1300 922 271



service.australia@einhell.com

### 7.3 Precision adjustment for 90° straight cut (Figs. 1, 6-8)

- Fasten the turntable (17) in 0° position.
- Undo the locking screw (21) and move the machine head (4) all the way to the right using the handle (1).
- Place the 90° angular stop (a) between the saw blade (7) and the turntable (17).
- Adjust the adjusting screw (29) using a Phillips head screw driver until the angle between the saw blade (7) and the turntable (17) equals 90°.
- Finally check the position of the pointer (20) on the scale (19). If necessary, undo the pointer (20) with a Phillips screwdriver, set it to the 0° position on the scale (19) and retighten the retainer screw.
- No stop angle included.

### 7.4 Precision adjustment for 45° bevel cut (Figs. 1, 7, 9)

- Fasten the turntable (17) in 0° position.
- Undo the locking screw (21) and move the machine head (4) all the way to the left using the handle (1), until it coincides at 45°.
- Place the 45° stop angle (b) between the blade (7) and the turntable. (17)
- Adjust the adjusting screw (30) so that the angle between the blade (7) and the turntable (17) equals exactly 45°.
- No stop angle included.

### 7.5 Adjusting the bevel angle (Figs. 2 & 13)

- Undo the locking screw (21).
- Hold the machine head (4) by the handle (1).
- After pulling the button (33), the machine head can be tipped infinitely as well as to several locking points.
- Angles to the left: 0-45°
- Angles to the right: 0-45°
- Re-tighten the locking screw (21).

### 7.6 Adjusting the removable fence (Figs. 1, 10-14)

- **Important!** This saw is equipped with a removable fence (9) which is screwed to the fixed fence (11).
- For bevel cuts and compound mitre cuts with the saw head tilted to the right, the removable fence (9) must be removed completely. **Important!** In this case the maximum permissible workpiece height is reduced (see 6. Technical data).
- To remove the fence (9) loosen the two screws (e) as shown in Fig. 10 and lift up the fence (9).
- Always fasten the removable fence (9) on the equipment again after you have completed your work.
- The fence must always remain together with the equipment. A removed fence will impair the operational safety of the equipment.

## 8. FUNCTIONS

### 8.1 Straight cut 90° (Figs. 1-3, 11)

For cutting widths up to approx. 100 mm it is possible to fix the saw's sliding function with the slide lock screw (24) in rear position. If the cutting width exceeds 100 mm, you must ensure that the slide lock screw (24) is slackened and that the machine head (4) can be moved.

- Move the machine head (4) to its upper position.
- Use the handle (1) to push back the machine head (4) and fix it in this position if required (dependant on the cutting width).
- Place the piece of wood to be cut at the fixed fence (11) and on the turntable (17).
- Lock the material with the clamping device (8) on the fixed saw table (18) to prevent the material from moving during the cutting operation.
- Push down the release lever (3) to release the machine head (4).
- Press the ON/OFF switch (2) to start the motor.
- With the slide guide (23) fixed in place: Use the handle (1) to move the machine head (4) steadily and with light pressure downwards until the saw blade (7) has completely cut through the workpiece.
- With the slide guide (23) not fixed in place: Pull the machine head (4) all the way to the front and then use the handle to move it downwards steadily and with light pressure. Now push the machine head (4) slowly and steadily to the very back until the saw blade (7) has completely cut through the workpiece.
- When the cutting operation is completed, move the machine head (4) back to its upper (home) position and release the ON/OFF switch (2).

**Important!** The integral resetting springs will automatically lift the machine head. Do not simply let go of the handle (1) after cutting, but allow the machine head (4) to rise slowly, applying slight counter pressure as it does so.

### 8.2 Mitre cut 0° - 45° (Figs. 1-3, 12)

The sliding mitre saw can be used to make mitre cuts of 0°- 45° to the left and 0° - 45° to the right in relation to the fence.

- Release the turntable (17) by turning the locking screw (14) into an anti-clockwise direction and pull the release device (37).
- Turn the turntable (17) and pointer (15) to the desired angular setting on the scale (16) and lock into place with the locking screw (14). The saw has locking positions at angles of - 45°, -31.6°, -22.5°, -15°, 0°, 15°, 22.5°, 31.6° and 45°, at which the turntable (17) audibly clicks into position.
- Retighten the locking screw (14) to secure the turntable (17) in place.
- Cut as described in section 8.1.



### 8.3 Bevel cut 0°- 45° (Figs. 1-3, 13)

The sliding mitre saw can be used to make bevel cuts to the left of 0°-45° and to the right of 0°-45° in relation to the work surface.

- If required, dismantle the clamping device (8) or mount on the opposite side of the fixed saw table (18).
- Move the machine head (4) to its upper position.
- Fasten the turntable (17) in 0° position.
- Adjust the bevel angle on the machine head (4) and the fence as described in section 7.5 and 7.6.
- Cut as described in section 8.1.

### 8.4 Compound Mitre cut 0°- 45° (Figs. 1-3, 14)

The sliding mitre saw can be used to make bevel cuts to the left of 0°-45° and to the right of 0°-45° in relation to the work surface and make mitre cuts from 0°-45° to the left or 0°-45° to the right in relation to the fence at the same time (compound mitre cut).

- If required, dismantle the clamping device (8) or mount on the opposite side of the fixed saw table (18).
- Move the machine head (4) to its upper position.
- Release the turntable (17) by turning the locking screw (14) into an anti-clockwise direction and pull the release device (37).
- Use the handle (1) to adjust the turntable (17) to the angle required (also refer to section 8.2).
- Retighten the locking screw (14) to secure the turntable (17) in place.
- Adjust the bevel angle on the machine head (4) and the fence as described in section 7.5 and 7.6.
- Cut as described in section 8.1.

### 8.5 Limiting the cutting depth (Fig. 15)

- The cutting depth can be infinitely adjusted using the knurled screw (27). Undo the nut on the knurled screw (27) and move the stop for limiting the cutting depth (28) to the outside. Set the required cutting depth by tightening or undoing the knurled screw (27) and then tighten the nut on the knurled screw (27).
- Check the setting by completing a test cut.

### 8.6 Sawdust bag (Fig. 1)

The saw is equipped with a dust bag (22) for sawdust and chips. Empty the dust bag (22) by unzipping the bottom part.

### 8.7 Changing the saw blade (Figs. 1, 16-18)

- **Important!** Before changing the saw blade, remove the power plug!
- Wear work gloves to prevent injury when changing the saw blade.
- Swing the machine head upwards (4).
- Undo the screw (z) on the cover plate (f) of the saw blade using the provided Allen Key (d).
- Pull back the adjustable blade guard (6) and at the same time turn the cover plate (f) to gain access to the flange bolt (31).
- Press the saw shaft lock (5) with one hand while positioning the Allen key (d) on the flange bolt (31) with the other hand. The saw shaft lock (5) engages after no more than one rotation.

- Now, using a little more force, slacken the flange bolt screw (31) in the clockwise direction.
- Turn the flange bolt (31) right out and remove the outer flange (32).
- Take the saw blade (7) off the inner flange and pull out downwards.
- Carefully clean the flange bolt (31), outer flange (32) and inner flange.
- Fit and fasten the new saw blade (7) in reverse order.
- **Important!** The cutting angle of the teeth, in other words the direction of rotation of the saw blade (7) must coincide with the direction of the arrow on the housing.
- Check to make sure that all safety devices are properly mounted and in good working condition before you begin working with the saw again.
- **Important!** Every time that you change the saw blade (7), check to see that it spins freely in the table insert (12) in both perpendicular and 45° angle settings.
- **Important!** The work to change and align the saw blade (7) must be carried out correctly.

### 8.8 Transport (Figs. 1-3)

- Retighten the locking screw (14) to secure the turntable (17) in place.
- Activate the release lever (3), press the machine head (4) downwards and secure with the fastening bolt (25). The saw is now locked in its bottom position.
- Fix the saw's sliding function with the slide lock screw (24) in rear position.
- Carry the equipment by the fixed saw table (18).
- To set up the equipment again, proceed as described in section 7.2.

### 8.9 Operating the laser (Figs.1 & 2)

To switch on: Move the ON/OFF switch for the laser (36) to the "I" position to switch on the laser (35). A laser line is projected onto the material you wish to process, providing an exact guide for the cut.

To switch off: Move the ON/OFF switch for the laser (36) to the "0" position.

### 8.10 Electric brake

For safety reasons, the equipment is supplied with an electric brake system for the saw blade. The equipment may therefore emit an odor or generate sparks when it is switched off. This has no influence on the operational performance or safety of the equipment.

## 9. REPLACING THE POWER CABLE

If the power cable for this equipment is damaged, it must be replaced by the manufacturer or its aftersales service or similarly trained personnel to avoid danger.



## 10. CLEANING, MAINTENANCE & ORDERING OF SPARE PARTS

Always pull out the power plug before starting any cleaning work.

### 10.1 Cleaning

- Keep all safety devices, air vents and the motor housing free of dirt and dust as far as possible. Wipe the equipment with a clean cloth or blow it down with compressed air at low pressure.
- We recommend that you clean the equipment immediately after you use it.
- Clean the equipment regularly with a damp cloth and some soft soap. Do not use cleaning agents or solvents; these may be aggressive to the plastic parts in the equipment. Ensure that no water can get into the interior of the equipment.

### 10.2 Carbon brushes

In case of excessive sparking, have the carbon brushes checked only by a qualified electrician. Important. The carbon brushes should not be replaced by anyone but a qualified electrician.

### 10.3 Servicing

There are no parts inside the equipment which require additional maintenance.

### 10.4 Ordering spare parts

Contact our After Sales Support on 1300 922 271 and quote the following data when ordering spare parts:

- Model/type of the equipment
- Article number of the equipment
- ID number of the equipment

## 11. STORAGE

Store the equipment and accessories out of children's reach in a dark and dry place at above freezing temperature. The ideal storage temperature is between 5 and 30 °C. Store the electric tool in its original packaging.

## 12. DISPOSAL AND RECYCLING

The equipment is supplied in packaging to prevent it from being damaged in transit. The raw materials in this packaging can be reused or recycled.

The equipment and its accessories are made of various types of material, such as metal and plastic. Defective components must be disposed of as special waste. Ask your local council.





**AFTER SALES SUPPORT**



1300 922 271



[service.australia@einhell.com](mailto:service.australia@einhell.com)

**AFTER SALES SUPPORT**



1300 922 271



[service.australia@einhell.com](mailto:service.australia@einhell.com)

**AFTER SALES SUPPORT**



1300 922 271



[service.australia@einhell.com](mailto:service.australia@einhell.com)

TAURUS TITANIUM® is a registered trademark of ALDI Stores.

**ALDI Guarantee**

Specially made for ALDI Stores to our stringent quality specifications. If you are not entirely satisfied with this product, please return it to your nearest ALDI store, within 60 days from the date of purchase, for a full refund or replacement, or take advantage of our after sales support by calling the Customer Service Hotline.

ALDI STORES  
1 SARGENTS ROAD  
MINCHINBURY NSW 2770  
AUSTRALIA  
[www.aldi.com.au](http://www.aldi.com.au)

10/2013

Art.Nr: 43.008.27\_11013

**AFTER SALES SUPPORT**



1300 922 271



[service.australia@einhell.com](mailto:service.australia@einhell.com)

20

MODEL NUMBER: TT-SM 2534 DUAL, 10/13