

OPERATION

5. TROUBLE SHOOTING

Problem	Cause	Solution
The compressor does not start	No supply voltage	Check the supply voltage, the power plug and the socket-outlet.
	Insufficient supply voltage	Make sure that the extension cable is not too long. Try another product in power point
	Outside temperature is too low	Never operate with an outside temperature of below 5°C.
	Motor is overheated	Allow the motor to cool down. If necessary, remedy the cause of the overheating.
The compressor starts but there is no pressure	The seals are damaged.	Check the seals and have any damaged seals replaced by a service centre
	Loose hose connections	Check the compressed air hose and tools and replace if necessary.
	Leak in a quick-lock coupling	Check the quick-lock coupling and replace if necessary.

MAINTENANCE

6. CLEANING & MAINTENANCE

IMPORTANT! BEFORE CLEANING YOUR COMPRESSOR OR CARRYING OUT ANY MAINTENANCE PROCEDURE, MAKE SURE THAT THE MOTOR IS OFF AND THE TOOL DISCONNECTED FROM THE POWER SUPPLY TO PREVENT ACCIDENTAL STARTING.

IMPORTANT! WAIT UNTIL THE COMPRESSOR HAS COMPLETELY COOLED DOWN. RISK OF BURNS!

IMPORTANT! ALWAYS DEPRESSURIZE THE EQUIPMENT BEFORE CARRYING OUT ANY CLEANING AND MAINTENANCE WORK.

Cleaning

- Keep the safety devices free of dirt and dust as far as possible. Wipe the equipment with a clean cloth or blow it with compressed air at low pressure.
- We recommend that you clean the appliance immediately after you use it.
- Clean the appliance regularly with a damp cloth and some soft soap. Do not use cleaning agents or solvents; these may be aggressive to the plastic parts in the appliance. Ensure that no water can get into the interior of the appliance.
- You must disconnect the hose and any spraying tools from the compressor before cleaning. Do not clean the compressor with water, solvents or the like.

7. STORAGE

IMPORTANT! STORE THE COMPRESSOR ONLY IN A DRY LOCATION WHICH IS NOT ACCESSIBLE TO UNAUTHORISED PERSONS. ALWAYS STORE UPRIGHT, NEVER TILTED!

DESCRIPTION OF SYMBOLS

V	Volts	Hz	Hertz
~	Alternating current	W	Watts
min ⁻¹	Revolutions or reciprocation per minute	Πo	No load speed
⚠	Warning	5124	Regulator compliance mark
🔊	Read instruction manual	97	Sound power level
⚡	Beware of electrical voltage	👂	Wear hearing protection
🔥	Beware of hot parts.	bar	Pressure rating
l	Litres	🔌	Double insulated

CARING FOR THE ENVIRONMENT

Power tools that are no longer usable should not be disposed of with household waste but in an environmentally friendly way. Please recycle where facilities exist. Check with your local council authority for recycling advice.

Recycling packaging reduces the need for landfill and raw materials. Reuse of recycled material decreases pollution in the environment. Please recycle packaging where facilities exist. Check with your local council authority for recycling advice.

SPARE PARTS

Gun with Gauge & Hose	402052101001
Air Nozzle	402052001040

Spare parts can be ordered from the Special Orders Desk at your local Bunnings Warehouse.

For further information, or any parts not listed here, visit www.ozito.com.au or contact Ozito Customer Service:

Australia 1800 069 486

New Zealand 0508 069 486

E-mail: enquires@ozito.com.au

ELECTRICAL SAFETY

WARNING! When using mains-powered tools, basic safety precautions, including the following, should always be followed to reduce risk of fire, electric shock, personal injury and material damage.

Read the whole manual carefully and make sure you know how to switch the tool off in an emergency, before operating the tool.

Save these instructions and other documents supplied with this tool for future reference.

The electric motor has been designed for 230V and 240V only. Always check that the power supply corresponds to the voltage on the rating plate.

Note: The supply of 230V and 240V on Ozito tools are interchangeable for Australia and New Zealand.

This tool is double insulated in accordance with AS/NZS 60335:2002; therefore no earth wire is required.

If the supply cord is damaged, it must be replaced by an electrician or a power tool repairer in order to avoid a hazard.

Note: Double insulation does not take the place of normal safety precautions when operating this tool. The insulation system is for added protection against injury resulting from a possible electrical insulation failure within the tool.

Using an Extension Lead

Always use an approved extension lead suitable for the power input of this tool. Before use, inspect the extension lead for signs of damage, wear and ageing. Replace the extension lead if damaged or defective. When using an extension lead on a reel, always unwind the lead completely. Use of an extension lead not suitable for the power input of the tool or which is damaged or defective may result in a risk of fire and electric shock.

The power outlet for the compressor is recommended to be protected by a 30amp residual current device

GENERAL POWER TOOL SAFETY WARNINGS-PERSONAL SAFETY

WARNING! Read all safety warnings and all instructions. Failure to follow the warnings and instructions may result in electric shock, fire and/or serious injury. Save all warnings and instructions for future reference. The term "power tool" in the warnings refers to your mains-operated (corded) power tool or battery-operated (cordless) power tool.

1. Work area safety

- Keep work area clean and well lit. Cluttered or dark areas invite accidents.
- Do not operate power tools in explosive atmospheres, such as in the presence of flammable liquids, gases or dust. Power tools create sparks which may ignite the dust or fumes.
- Keep children and bystanders away while operating a power tool. Distractions can cause you to lose control.

2. Electrical safety

- Power tool plugs must match the outlet. Never modify the plug in any way. Do not use any adapter plugs with earthed (grounded) power tools. Unmodified plugs and matching outlets will reduce risk of electric shock.
- Avoid body contact with earthed or grounded surfaces, such as pipes, radiators, ranges and refrigerators. There is an increased risk of electric shock if your body is earthed or grounded.
- Do not expose power tools to rain or wet conditions. Water entering a power tool will increase the risk of electric shock.
- Do not abuse the cord. Never use the cord for carrying, pulling or unplugging the power tool. Keep cord away from heat, oil, sharp edges or moving parts. Damaged or entangled cords increase the risk of electric shock.
- When operating a power tool outdoors, use an extension cord suitable for outdoor use. Use of a cord suitable for outdoor use reduces the risk of electric shock.
- If operating a power tool in a damp location is unavoidable, use a residual current device (RCD) protected supply. Use of an RCD reduces the risk of electric shock.

3. Personal safety

- Stay alert, watch what you are doing and use common sense when operating a power tool. Do not use a power tool while you are tired or under the influence of drugs, alcohol or medication. A moment of inattention while operating power tools may result in serious personal injury.
- Use personal protective equipment. Always wear eye protection. Protective equipment such as dust mask, non-skid safety shoes, hard hat, or hearing protection used for appropriate conditions will reduce personal injuries.
- Prevent unintentional starting. Ensure the switch is in the off-position before connecting to power source and/or battery pack, picking up or carrying the tool. Carrying power

tools with your finger on the switch or energising power tools that have the switch on invites accidents.

- Remove any adjusting key or wrench before turning the power tool on. A wrench or a key left attached to a rotating part of the power tool may result in personal injury.
- Do not overreach. Keep proper footing and balance at all times. This enables better control of the power tool in unexpected situations.
- Dress properly. Do not wear loose clothing or jewellery. Keep your hair, clothing and gloves away from moving parts. Loose clothes, jewellery or long hair can be caught in moving parts.
- If devices are provided for the connection of dust extraction and collection facilities, ensure these are connected and properly used. Use of dust collection can reduce dust-related hazards.
- Power tool use and care
 - Do not force the power tool. Use the correct power tool for your application. The correct power tool will do the job better and safer at the rate for which it was designed.
 - Do not use the power tool if the switch does not turn it on and off. Any power tool that cannot be controlled with the switch is dangerous and must be repaired.
 - Disconnect the plug from the power source and/or the battery pack from the power tool before making any adjustments, changing accessories, or storing power tools. Such preventive safety measures reduce the risk of starting the power tool accidentally.
 - Store idle power tools out of the reach of children and do not allow persons unfamiliar with the power tool or these instructions to operate the power tool. Power tools are dangerous in the hands of untrained users.
 - Maintain power tools. Check for misalignment or binding of moving parts, breakage of parts and any other condition that may affect the power tool's operation. If damaged, have the power tool repaired before use. Many accidents are caused by poorly maintained power tools.
 - Keep cutting tools sharp and clean. Properly maintained cutting tools with sharp cutting edges are less likely to bind and are easier to control.
 - Use the power tool, accessories and tool bits etc. in accordance with these instructions, taking into account the working conditions and the work to be performed. Use of the power tool for operations different from those intended could result in a hazardous situation.
- Service
 - Have your power tool serviced by a qualified repair person using only identical replacement parts. This will ensure that the safety of the power tool is maintained.
 - If the supply cord is damaged, it must be replaced by the manufacturer, its service agent or similarly qualified persons in order to avoid a hazard.

AIR COMPRESSOR SAFETY WARNINGS

This appliance is not intended for use by young or infirm persons unless supervised by a responsible person to ensure that they can use the appliance safely. Young children should be supervised to ensure that they do not play with play with the appliance.

WARNING! Before connecting a tool to a power source (mains switch power point receptacle, outlet, etc.) be sure that the voltage supply is the same as that specified on the nameplate of the tool. A power source with a voltage greater than that specified for the tool can result in serious injury to the user, as well as damage to the tool. If in doubt, do not plug in the tool. Using a power source with a voltage less than the nameplate rating is harmful to the motor.

Always remove the plug from the mains socket before making any adjustments or maintenance.

- To reduce the risk of fire or explosion, never spray flammable liquids in a confined area. If sparks come into contact with petrol vapours or solvents, they may ignite the vapours and cause a fire or explosion.
- Always operate the compressor in a well ventilated area. Do not smoke while spraying. Do not spray where sparks or flames are present. Keep the compressor as far away from the spray area as possible.
- The solvents trichloroethane and methylene chloride can chemically react with the aluminium used in some paint spray guns and form an explosion. If these solvents are used, ensure that only stainless steel spray equipment is connected. The compressor is not affected by the use of these solvents.
- Never directly inhale the compressed air produced by a compressor and do not use it for charging breathing tanks.
- Do not use welding equipment in close proximity to the compressor. Do not weld anything to the air tank of the compressor; this could dangerously weaken the tank and void the warranty.
- Do not use the compressor outdoors when it is raining or on a wet surface; either situation could cause an electric shock.
- Always maintain a safety distance of at least 3 meters between the compressor and the work area. Ensure that the compressor is on a stable surface.
- Always use the handle to move the compressor.
- Never let the compressor come into contact with water or other liquids, as the appliance is live, this could cause electrocution or short-circuits. Never use the appliance with bare feet, wet hands or wet feet.
- Never pull on the power cable to disconnect the plug from the power outlet or to move the compressor.
- The compressed air produced by the compressor cannot be used for pharmaceutical, food or medical purposes or to fill the air bottles of scuba divers.
- Do not cover the air inlets on the compressor.
- Compressors and lines reach high temperatures during operation. Avoid contact! Risk of burns!
- Gases or vapours drawn in by the compressor have to be kept free of constituents that may cause fire or explosions inside the compressor.
- When you disconnect the hose coupling, hold the coupling element in your hand to prevent injury from the whipping hose.
- Never point the blow-out gun at other persons and never use it to clean clothes that are still being worn.

- Be certain to read all the labels on the containers of paint or other materials to be sprayed. Closely follow all safety instructions. Use a respirator mask if there is a chance that you might otherwise inhale the spray material. Carefully check the effectiveness of any respirator mask you intend using.
- Always wear safety goggles or glasses when using the air compressor. Never point the nozzle of an accessory towards any part of your body or towards another person.
- Keep the compressor at least 300mm from the nearest wall to ensure adequate ventilation for cooling purposes.
- Protect the air hose and cordset from damage. Inspect for weak or worn spots regularly and replace if necessary.
- Avoid using an extension cord with this product. Use additional air hose instead of an extension cord to prevent power loss and possible damage to the motor. Use of an extension cord voids the warranty.
- Always switch off the compressor before switching off the power or removing the power plug.
- After using the compressor, switch off the on/off button, disconnect the power supply and release any remaining pressure.
- Do not attempt to remove any part of the machine whilst it is under pressure.
- Use safety equipment including safety goggles or shield, ear protection, breathing or respirator mask and protective clothing.

Wear goggles, wear earmuffs, wear a breathing mask

Never apply the outlet air of this compressor directly on to any part of a person's body. Do not attempt to block the air outlet with your finger or any part of your body.

The tool must be used only for its prescribed purpose. Any use other than those mentioned in this Manual will be considered a case of misuse. The user and not the manufacturer shall be liable for any damage or injury resulting from such cases of misuse.

The manufacturer shall not be liable for any changes made to the tool nor for any damage resulting from such changes.

Even when the tool is used as prescribed it is not possible to eliminate all residual risk factors. The following hazards may arise in connection with the tool's construction and design:

- Damage to the lungs if an effective breathing mask is not worn.
- Damage to hearing if effective earmuffs are not worn.
- Damage to the eyes if effective safety goggles or shield are not worn.

WARNING! In the event that an air line is cut or broken, the air supply must be turned off at the compressor. A broken air line which is not supported is extremely dangerous and can whip around very quickly, both with the capability of striking people, and blowing foreign particles into the air.

Do not attempt to catch the air line but immediately keep bystanders well clear and turn off the air supply to the hose, turn off the compressor at the On / Off button, and then remove the hose from the compressor.

ozito

INFLATE-IT COMPRESSOR KIT

1100 W

INSTRUCTION MANUAL

SPECIFICATIONS

Power supply:	230 – 240V – 50Hz
Motor:	1100W (S3:15%)
No Load Speed:	3,550/min
Max. Pressure:	8bar (116psi)
Max. Flow Rate:	140 l/min
IP Rating:	IP20
Product weight:	5.7 kg

ozito.com.au

3 YEAR REPLACEMENT WARRANTY

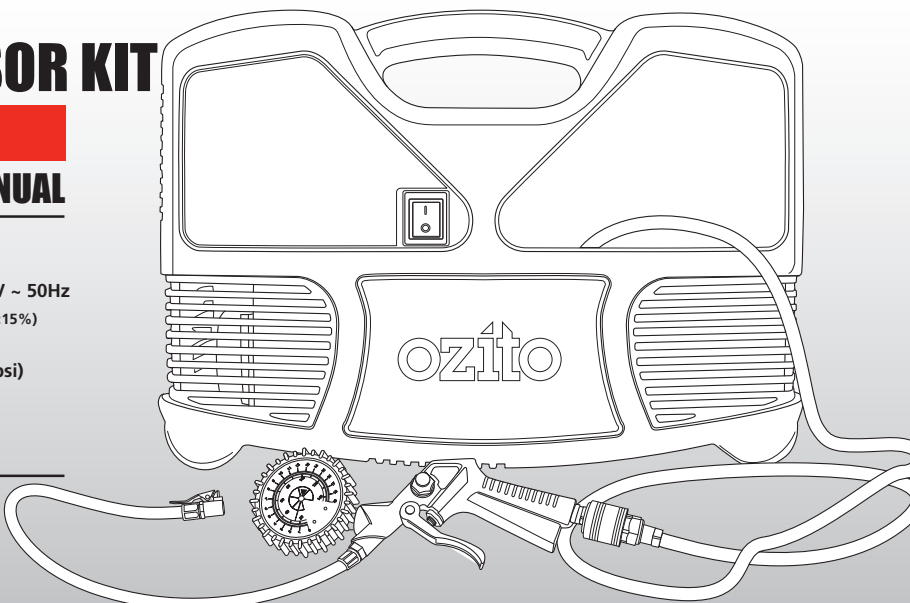

WHAT'S IN THE BOX

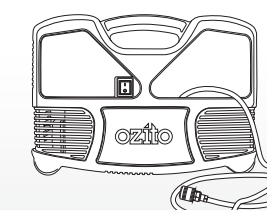

Air Compressor



Air Gun



Air Nozzle



Inflation Adaptors x 3

ACK-0015

WARRANTY

IN ORDER TO MAKE A CLAIM UNDER THIS WARRANTY YOU MUST RETURN THE PRODUCT TO YOUR NEAREST BUNNINGS WAREHOUSE WITH YOUR BUNNINGS REGISTER RECEIPT. PRIOR TO RETURNING YOUR PRODUCT FOR WARRANTY PLEASE TELEPHONE OUR CUSTOMER SERVICE HELPLINE:

Australia 1800 069 486

New Zealand 0508 069 486

TO ENSURE A SPEEDY RESPONSE PLEASE HAVE THE MODEL NUMBER AND DATE OF PURCHASE AVAILABLE. A CUSTOMER SERVICE REPRESENTATIVE WILL TAKE YOUR CALL AND ANSWER ANY QUESTIONS YOU MAY HAVE RELATING TO THE WARRANTY POLICY OR PROCEDURE.

The benefits provided under this warranty are in addition to other rights and remedies which are available to you at law.

Our goods come with guarantees that cannot be excluded at law. You are entitled to a replacement or refund for a major failure and for compensation for any other reasonably foreseeable loss or damage. You are also entitled to have the goods repaired or replaced if the goods fail to be of acceptable quality and the failure does not amount to a major failure.

Generally you will be responsible for all costs associated with a claim under this warranty, however, where you have suffered any additional direct loss as a result of a defective product you may be able to claim such expenses by contacting our customer service helpline above.

3 YEAR REPLACEMENT WARRANTY

Your product is guaranteed for a period of **36 months** from the **original date of purchase**. If a product is defective it will be replaced in accordance with the terms of this warranty. Warranty excludes consumable parts, for example: valve adaptors and accessories.

WARNING

The following actions will result in the warranty being void.

- If the tool has been operated on a supply voltage other than that specified on the tool.
- If the tool shows signs of damage or defects caused by or resulting from abuse, accidents or alterations.
- Failure to perform maintenance as set out within the instruction manual.
- If the tool is disassembled or tampered with in any way.
- Professional, industrial or high frequency use.

KNOW YOUR PRODUCT

AIR COMPRESSOR

- Supporting Foot
- Housing
- ON/OFF Switch
- Transport Handle
- Quick-release Nitto Coupling
- Compressed Air Hose

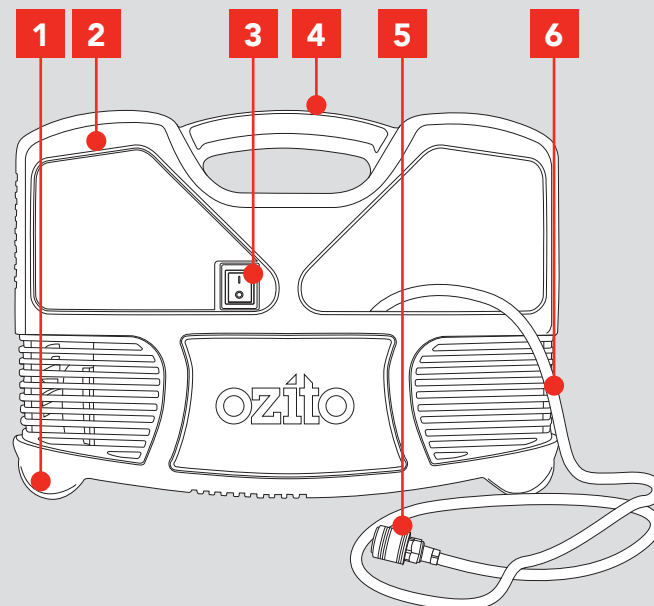

ACCESSORIES

- Air Gun
- Air Hose
- Valve Connector
- Pressure Gauge
- Air Gun Trigger
- Integrated Release Valve
- Blower Nozzle
- Inflation Adaptors

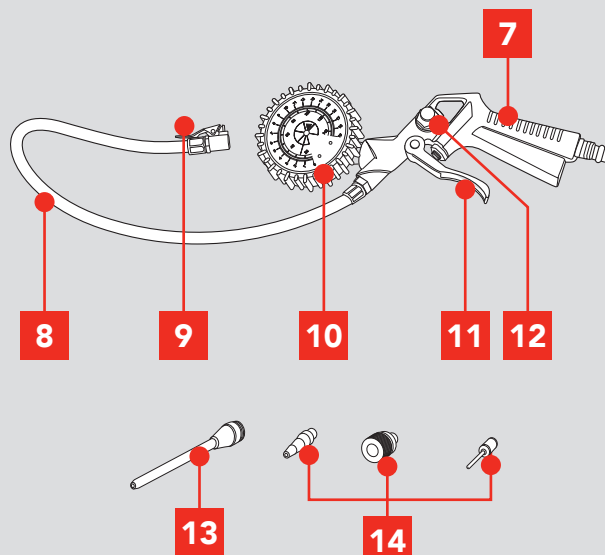

ONLINE MANUAL

Scan this QR Code with your mobile device to take you to the online manual.

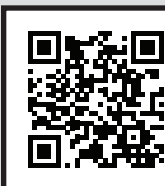

SETUP & PREPARATION

1. ASSEMBLY AND STARTING

Pre Setup Checks

- Examine the machine for signs of transit damage. If damaged, do not use, return to place of purchase
- The compressor should be set up near to the user.
- Avoid long air lines and long supply lines (extensions).
- Make sure the intake air is dry and dust-free.
- Do not set up the compressor in damp or wet rooms.
- The compressor is designed to be used in dry rooms. It is prohibited to use the compressor in areas where work is conducted with sprayed water. Before you use the machine, make sure that the mains voltage complies with the specifications on the rating plate.

Connecting to the Compressed Air Hose

IMPORTANT! BEFORE CONNECTING OR DISCONNECTING ACCESSORIES, ALWAYS MAKE SURE THAT THE COMPRESSOR IS OFF.

- Insert the nipple of the air tool into the quick-lock coupling of the air hose.

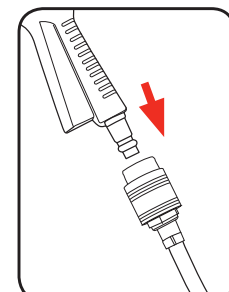

- The quick-lock sleeve will spring forward automatically, connecting the accessory.

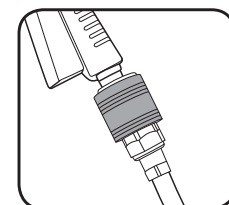

Disconnecting

- To disconnect the air tool, pull back the sleeve on the quick-lock coupling and remove the tool.

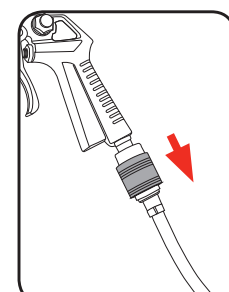

IMPORTANT! WHEN RELEASING THE QUICK-RELEASE COUPLING, BE SURE TO HOLD THE COUPLING PIECE TO PROTECT YOURSELF AGAINST INJURY FROM THE REBOUNDED HOSE.

OPERATION

2. OPERATION

Switching On and Off

Note: It is recommended to use in conjunction with this appliance a Residual Current Device (RCD) of rating not exceeding 30mA.

- Attach the desired tool to the quick release coupling of the air hose.

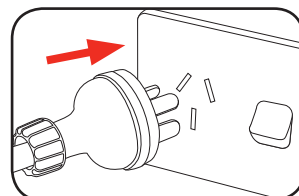

- Connect the compressors' power cord to the mains power supply.

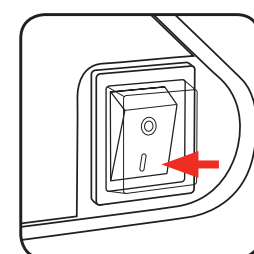

- To switch ON the equipment, set the On/Off switch to position "I" (On).

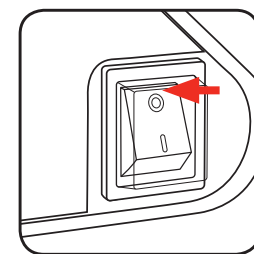

- To switch OFF the equipment, move the On/Off switch to position "0" (Off). Disconnect the power cord from the mains.

- Run the attached air tool until no compressed air remains in the hose.

WARNING! COMPRESSED AIR CAN BE A DANGEROUS FORM OF ENERGY. GREAT CARE IS REQUIRED WHEN USING THE COMPRESSOR AND ITS ACCESSORIES.

3. INFLATING

Inflating Tyres

- Attach the air gun to the compressed air hose.

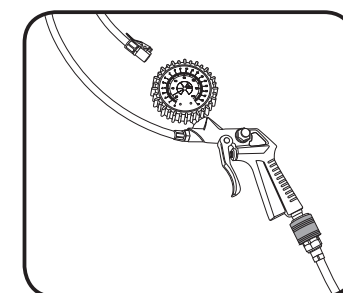

- When inflating tyres with normal "Schrader" valves, no adaptors need to be fitted to the rubber hose.

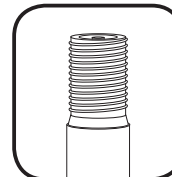

- Connect the rubber hose of the air gun to the tyre by pressing the end of the hose onto the tyre valve while holding down the hose tab.

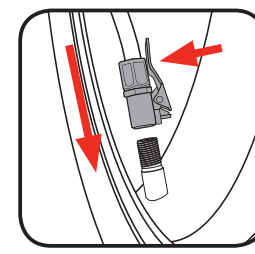

- Release the valve connector. The hose will now be connected to the tyre valve.

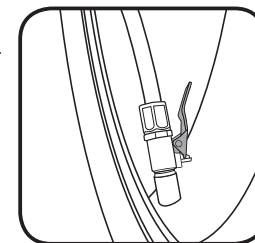

- To inflate the tyre, hold down the trigger of the air gun.

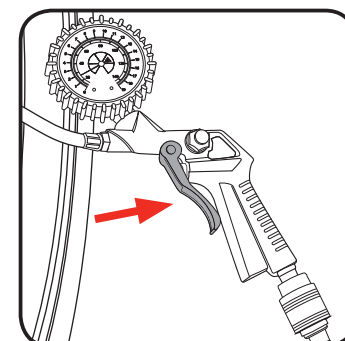

- After a short time, release the trigger and check the tyre pressure by referring to the pressure gauge.

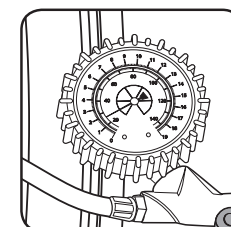

IMPORTANT! AVOID INFLATING THE OBJECTS ABOVE THE RECOMMENDED INFLATION PRESSURE. THIS MAY LEAD TO DAMAGE AND/OR INJURIES.

- If the tyre pressure is too high, it can be reduced with the integrated release valve.

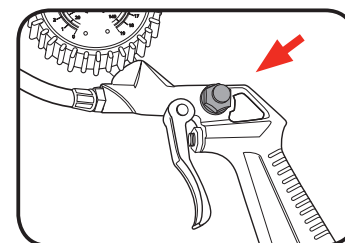

Inflating other items

The compressor kit is supplied with a variety of adaptors that can be fitted to the rubber hose. These adaptors are suitable for different valves that are often used on inflatable items:

Adapter A is used for footballs, basketballs, soccer balls etc.

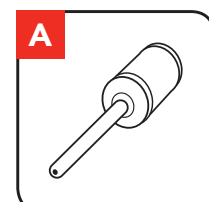

Adapter B is used for rubber dinghies, inflatable small swimming pools and air beds.

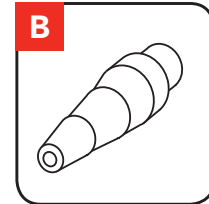

Adapter C is used for bicycle tyres with "French" or "Presta" valves.

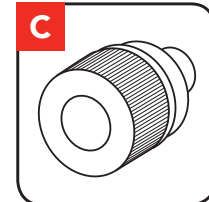

Attaching Inflation Adaptors to the Rubber Hose

- Push the suitable adaptor into the rubber hose while pressing the hose tab.

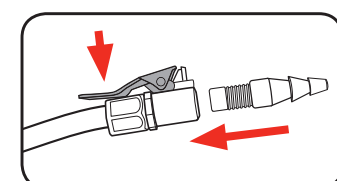

- Once it is inserted, release the hose tab.

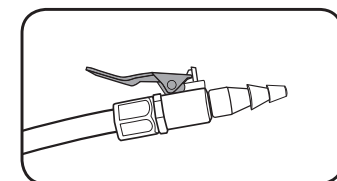

- Turn the adaptor in a clockwise direction to secure it in place.

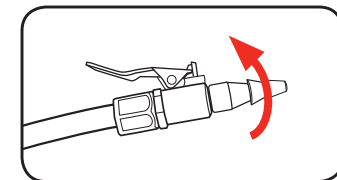

4. BLOWER PISTOL

Using the Equipment as a Blower Pistol

- To use the air gun as a blower pistol you must first unscrew and remove the rubber hose.

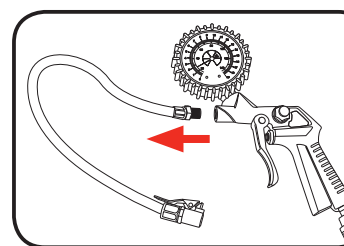

- The blower nozzle can then be screwed into the inflation gun.

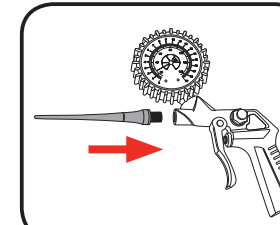

- By varying the pressure on the trigger, you can control the amount of compressed air released through the air nozzle.

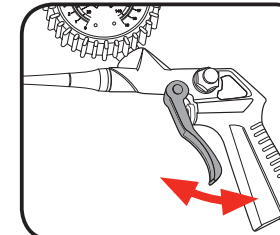

WARNING! OPERATOR IS ADVISED TO WEAR EYE PROTECTION WHEN USING THE AIR GUN. TAKE CARE NOT TO BLOW DIRT OR OTHER LOOSE PARTICLES TOWARDS YOURSELF OR OTHER PERSONS

- The blower nozzle adapter is useful for blowing dust out of hollow spaces or hard to reach areas, such as vents in electrical items or between the keys of a keyboard. It is also useful for cleaning soiled equipment.

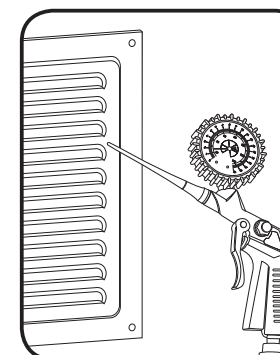

WARNING! DO NOT DIRECT THE JET OF COMPRESSED AIR TOWARDS PEOPLE OR ANIMALS.