

MAINTENANCE

- Keep the ventilation vents of the angle grinder clean at all times, if possible, prevent foreign matter from entering the vents.
- The grease in the gearbox will require replacement / replenishment after extensive use of the grinder. Please see a qualified electrical repairer to provide this service.
- After each use, blow air through the angle grinder housing to ensure it is free from all dust particles which may build up. Build up of dust particles may cause the angle grinder to overheat and fail.
- If the enclosure of the angle grinder requires cleaning, do not use solvents but a moist soft cloth only. Never let any liquid get inside the angle grinder; never immerse any part of the angle grinder into a liquid.

Carbon Brushes



When the carbon brushes wear out, the angle grinder will spark and/or stop. Discontinue use as soon as this happens. They should be replaced prior to recommencing use of the angle grinder. Carbon brushes are a wearing component of the angle grinder therefore not covered under warranty. Continuing to use the angle grinder when carbon brushes need to be replaced may cause permanent damage. Carbon brushes will wear out after many uses but when the carbon brushes need to be replaced, take the angle grinder to an electrician or a power tool repairer for a quick and low cost replacement. Always replace both carbon brushes at the same time.

Note: Ozito Industries will not be responsible for any damage or injuries caused by the repair of the angle grinder by an unauthorised person or by mishandling of the angle grinder.

DESCRIPTION OF SYMBOLS

V	Volts	Hz	Hertz
~	Alternating current	W	Watts
/min	Revolutions or reciprocation per minute	Πo	No load speed
	Double insulated		Regulator compliance mark
	Wear close toed shoes		Read instruction manual
	Always wear ear, eye and safety mask		Always wear gloves
	Warnings against potential safety hazards which may lead to serious injury and/or property damage.		

CARING FOR THE ENVIRONMENT



Power tools that are no longer usable should not be disposed of with household waste but in an environmentally friendly way. Please recycle where facilities exist. Check with your local council authority for recycling advice.



Recycling packaging reduces the need for landfill and raw materials. Reuse of recycled material decreases pollution in the environment. Please recycle packaging where facilities exist. Check with your local council authority for recycling advice.

TROUBLESHOOTING

Sparking visible through the housing air vents

A small amount of sparking may be visible through the housing vents. This is normal and does not indicate a problem.

Excessive sparking visible through the housing air vents and/or the angle grinder failing to operate



May indicate the carbon brushes have worn out and need to be replaced. Carbon brushes should only be replaced by a qualified electrician or power tool repairer.

Guard lever will not close

The guard nut may be over tightened. Loosen guard nut slightly and try to close guard lever again.

Guard lever closes but doesn't securely fasten guard/ the guard rattles or moves during tool use

The guard nut may not be tight enough. Tighten the guard nut and then close the guard lever.

SPARE PARTS

Spare parts can be ordered from the Special Orders Desk at your local Bunnings Warehouse.

For further information, or any parts not listed here, visit

www.ozito.com.au or contact Ozito Customer Service:

Australia 1800 069 486

New Zealand 0508 069 486

E-mail: enquiries@ozito.com.au

ELECTRICAL SAFETY

The electric motor has been designed for 230V and 240V only. Always check that the power supply corresponds to the voltage on the rating plate.

Note: The supply of 230V and 240V on Ozito tools are interchangeable for Australia and New Zealand.



This tool is double insulated therefore no earth wire is required. If the supply cord of this power tool is damaged, it must be replaced by a specially prepared cord available through the service organization.

Note: Double insulation does not take the place of normal safety precautions when operating this tool. The insulation system is for added protection against injury resulting from a possible electrical insulation failure

GENERAL POWER TOOL SAFETY WARNINGS

- WARNING!** Read all safety warnings and all instructions. Failure to follow the warnings and instructions may result in electric shock, fire and/or serious injury.
- Save all warnings and instructions for future reference. The term "power tool" in the warnings refers to your mains-operated (corded) power tool or battery-operated (cordless) power tool.
1. Work area safety
 - a. Keep work area clean and well lit. Cluttered or dark areas invite accidents.
 - b. Do not operate power tools in explosive atmospheres, such as in the presence of flammable liquids, gases or dust. Power tools create sparks which may ignite the dust or fumes.
 - c. Keep children and bystanders away while operating a power tool. Distractions can cause you to lose control.
 2. Electrical safety
 - a. Power tool plugs must match the outlet. Never modify the plug in any way. Do not use any adapter plugs with earthed (grounded) power tools. Unmodified plugs and matching outlets will reduce risk of electric shock.
 - b. Avoid body contact with earthed or grounded surfaces, such as pipes, radiators, ranges and refrigerators. There is an increased risk of electric shock if your body is earthed or grounded.
 - c. Do not expose power tools to rain or wet conditions. Water entering a power tool will increase the risk of electric shock.
 - d. Do not abuse the cord. Never use the cord for carrying, pulling or unplugging the power tool. Keep cord away from heat, oil, sharp edges or moving parts. Damaged or entangled cords increase the risk of electric shock.
 - e. When operating a power tool outdoors, use an extension cord suitable for outdoor use. Use of a cord suitable for outdoor use reduces the risk of electric shock.
 3. Personal safety
 - a. Stay alert, watch what you are doing and use common sense when operating a power tool. Do not use a power tool while you are tired or under the influence of drugs, alcohol or medication. A moment of inattention while operating power tools may result in serious personal injury.
 - b. Use personal protective equipment. Always wear eye protection. Protective equipment such as dust mask, non-skid safety shoes, hard hat, or hearing protection used for appropriate conditions will reduce personal injuries.
 - c. Prevent unintentional starting. Ensure the switch is in the off-position before connecting to power source and/or battery pack, picking up or carrying the tool. Carrying power tools with your finger on the switch or energising power tools that have the switch on invites accidents.

ANGLE GRINDER SAFETY WARNINGS

- WARNING!** a) This power tool is intended to function as a grinder or cut-off tool. Read all safety warnings, instructions, illustrations and specifications provided with this power tool. Failure to follow all instructions listed below may result in electric shock, fire and/or serious injury.
- b) Operations such as sanding, wire brushing, or polishing are not recommended to be performed with this power tool. Operations for which the power tool was not designed may create a hazard and cause personal injury.
- c) Do not use accessories which are not specifically designed and recommended by the tool manufacturer. Just because the accessory can be attached to your power tool, it does not assure safe operation.
- d) The rated speed of the accessory must be at least equal to the maximum speed marked on the power tool. Accessories running faster than their rated speed can break and fly apart.
- e) The outside diameter and the thickness of your accessory must be within the capacity rating of your power tool. Incorrectly sized accessories cannot be adequately guarded or controlled.
- f) Threaded mounting of accessories must match the grinder spindle thread. For accessories mounted by flanges, the arbour hole of the accessory must fit the locating diameter of the flange. Accessories that do not match the mounting hardware of the power tool will run out of balance, vibrate excessively and may cause loss of control.
- g) Do not use a damaged accessory. Before each use inspect the accessory such as abrasive wheels for chips and cracks, backing pad for cracks, tear or excess wear, wire brush for loose or cracked wires. If power tool or accessory is dropped, inspect for damage or install an undamaged accessory. After inspecting and installing an accessory, position yourself and bystanders away from the plane of the rotating accessory and run the power tool at maximum no-load speed for one minute. Damaged accessories will normally break apart during this test time.
- h) Wear personal protective equipment. Depending on application, use face shield, safety goggles or safety glasses. As appropriate, wear dust mask, hearing protectors, gloves and workshop apron capable of stopping small abrasive or work piece fragments. The eye protection must be capable of stopping flying debris generated by various operations. The dust mask or respirator must be capable of filtering particles generated by your operation. Prolonged exposure to high intensity noise may cause hearing loss.
- i) Keep bystanders a safe distance away from work area. Anyone entering the work area must wear personal protective equipment. Fragments of workpiece or of a broken accessory may fly away and cause injury beyond immediate area of operation.
- j) Hold power tool by insulated gripping surfaces only, when performing an operation where the cutting accessory may contact hidden wiring or its own cord. Cutting accessory contacting a "live" wire may make exposed metal parts of the power tool "live" and shock the operator.
- k) Position the cord clear of the spinning accessory. If you lose control, the cord may be cut or snagged and your hand or arm may be pulled into the spinning accessory.
- l) Never lay the power tool down until the accessory has come to a complete stop. The spinning accessory may grab the surface and pull the power tool out of your control.
- m) Do not run the power tool while carrying it at your side. Accidental contact with the spinning accessory could snag your clothing, pulling the accessory into your body.
- n) Regularly clean the power tool's air vents. The motor's fan will draw the dust inside the housing and excessive accumulation of powdered metal may cause electrical hazards.
- o) Do not operate the power tool near flammable materials. Sparks could ignite these materials.
- p) Do not use accessories that require liquid coolants. Using water or other liquid coolants may result in electrocution or shock.
- Kickback and related warnings**
- Kickback is a sudden reaction to a pinched or snagged rotating wheel, backing pad, brush or any other accessory. Pinching or snagging causes rapid stalling of the rotating accessory which in turn causes the uncontrolled power tool to be forced in the direction opposite of the accessory's rotation at the point of the binding.
- For example, if an abrasive wheel is snagged or pinched by the work piece, the edge of the wheel that is entering into the pinch point can dig into the surface of the material causing the wheel to climb out or kick out. The wheel may either jump toward or away from the operator, depending on direction of the wheel's movement at the point of pinching. Abrasive wheels may also break under these conditions. Kickback is the result of power tool misuse and/or incorrect operating procedures or conditions and can be avoided by taking proper precautions as given below.

within the tool.

Using an Extension Lead

Always use an approved extension lead suitable for the power input of this tool. Before use, inspect the extension lead for signs of damage, wear and ageing. Replace the extension lead if damaged or defective. When using an extension lead on a reel, always unwind the lead completely. Use of an extension lead not suitable for the power input of the tool or which is damaged or defective may result in a risk of fire and electric shock.

- a. Remove any adjusting key or wrench before turning the power tool on. A wrench or a key left attached to a rotating part of the power tool may result in personal injury.
- b. Do not overreach. Keep proper footing and balance at all times. This enables better control of the power tool in unexpected situations.
- c. Dress properly. Do not wear loose clothing or jewellery. Keep your hair, clothing and gloves away from moving parts. Loose clothes, jewellery or long hair can be caught in moving parts.
- d. If devices are provided for the connection of dust extraction and collection facilities, ensure these are connected and properly used. Use of dust collection can reduce dust-related hazards.
- e. Do not let familiarity gained from frequent use of tools allow you to become complacent and ignore tool safety principles. A careless action can cause severe injury within a fraction of a second.
- f. Power tool use and care
 - a. Do not force the power tool. Use the correct power tool for your application. The correct power tool will do the job better and safer at the rate for which it was designed.
 - b. Do not use the power tool if the switch does not turn it on and off. Any power tool that cannot be controlled with the switch is dangerous and must be repaired.
 - c. Disconnect the plug from the power source and/or the battery pack from the power tool before making any adjustments, changing accessories, or storing power tools. Such preventive safety measures reduce the risk of starting the power tool accidentally.
 - d. Store idle power tools out of the reach of children and do not allow persons unfamiliar with the power tool or these instructions to operate the power tool. Power tools are dangerous in the hands of untrained users.
 - e. Maintain power tools. Check for misalignment or binding of moving parts, breakage of parts and any other condition that may affect the power tool's operation. If damaged, have the power tool repaired before use. Many accidents are caused by poorly maintained power tools.
 - f. Keep cutting tools sharp and clean. Properly maintained cutting tools with sharp cutting edges are less likely to bind and are easier to control.
 - g. Use the power tool, accessories and tool bits etc. in accordance with these instructions, taking into account the working conditions and the work to be performed. Use of the power tool for operations different from those intended could result in a hazardous situation.
 - h. Keep handles and grasping surfaces dry, clean and free from oil and grease. Slippery handles and grasping surfaces do not allow for safe handling and control of the tool in unexpected situations.
5. Service
 - a. Have your power tool serviced by a qualified repair person using only identical replacement parts. This will ensure that the safety of the power tool is maintained.

- a) Maintain a firm grip on the power tool and position your body and arm to allow you to resist kickback forces. Always use auxiliary handle, if provided, for maximum control over kickback or torque reaction during start-up. The operator can control torque reactions or kickback forces, if proper precautions are taken.
 - b) Never place your hand near the rotating accessory. Accessory may kickback over your hand.
 - c) Do not position your body in the area where power tool will move if kickback occurs. Kickback will propel the tool in direction opposite to the wheel's movement at the point of snagging.
 - d) Use special care when working corners, sharp edges etc. Avoid bouncing and snagging the accessory. Corners, sharp edges or bouncing have a tendency to snag the rotating accessory and cause loss of control or kickback.
 - e) Do not attach a saw chain woodcarving blade or toothed saw blade. Such blades create frequent kickback and loss of control.
- Additional safety instructions for grinding and abrasive cutting-off operations**
- a) Use only wheel types that are recommended for your power tool and the specific guard designed for the selected wheel. Wheels for which the power tool was not designed cannot be adequately guarded and are unsafe.
 - b) The grinding surface of centre depressed wheels must be mounted below the plane of the guard lip. An improperly mounted wheel that projects through the plane of the guard lip cannot be adequately protected.
 - c) The guard must be securely attached to the power tool and positioned for maximum safety, so the least amount of wheel is exposed towards the operator. The guard helps to protect operator from broken wheel fragments and accidental contact with wheel.
 - d) Wheels must be used only for recommended applications. For example: do not grind with the side of cut-off wheel. Abrasive cut-off wheels are intended for peripheral grinding, side forces applied to these wheels may cause them to shatter.
 - e) Always use undamaged wheel flanges that are of correct size and shape for your selected wheel. Proper wheel flanges support the wheel thus reducing the possibility of wheel breakage. Flanges for cut-off wheels may be different from grinding wheel flanges.
 - f) Do not use worn down wheels from larger power tools. Wheel intended for larger power tool is not suitable for the higher speed of a smaller tool and may burst.
- Additional safety instructions for abrasive cutting-off operations:**
- a) Do not "jam" the cut-off wheel or apply excessive pressure. Do not attempt to make an excessive depth of cut. Overstressing the wheel increases the loading and susceptibility to twisting or binding of the wheel in the cut and the possibility of kickback or wheel breakage.
 - b) Do not position your body in line with and behind the rotating wheel. When the wheel, at the point of operation, is moving away from your body, the possible kickback may propel the spinning wheel and the power tool directly at you.
 - c) When wheel is binding or when interrupting a cut for any reason, switch off the power tool and hold the power tool motionless until the wheel comes to a complete stop. Never attempt to remove the cut-off wheel from the cut while the wheel is in motion otherwise kickback may occur. Investigate and take corrective action to eliminate the cause of wheel binding.
 - d) Do not restart the cutting operation in the work piece. Let the wheel reach full speed and carefully reenter the cut. The wheel may bind, walk up or kickback if the power tool is restarted in the work piece.
 - e) Support panels or any oversized work piece to minimize the risk of wheel pinching and kickback. Large work pieces tend to sag under their own weight. Supports must be placed under the work piece near the line of cut and near the edge of the work piece on both sides of the wheel.
 - f) Use extra caution when making a "pocket cut" into existing walls or other blind areas. The protruding wheel may cut gas or water pipes, electrical wiring or objects that can cause kickback.
- The tool is recommended for use with a residual current device with a rated residual current of 30mA or less.

Warnings Specific to Angle Grinder Operations:

- a) Flanges must suit the disc and application and be in good condition.
- b) Discs should be stored and handled carefully to avoid damage.
- c) Grinding discs are for grinding applications only. Cutting discs are for cutting applications only.
- d) Never apply pressure to stop a disc spinning.
- e) The workpiece should be securely held down and supported.

ozito

ANGLE GRINDER

230mm (9") 2350W

INSTRUCTION MANUAL

SPECIFICATIONS

Rated Voltage:	230-240V ~50Hz
Motor:	2350W
Rated Speed:	6,000/min
Disc Diameter:	230mm
Spindle:	M14
Bore:	22mm
Disc Thickness:	6mm (Grinding) 3mm (Cutting)
Weight:	5kg

ozito.com.au

3 YEAR REPLACEMENT WARRANTY

WARRANTY

IN ORDER TO MAKE A CLAIM UNDER THIS WARRANTY YOU MUST RETURN THE PRODUCT TO YOUR NEAREST BUNNINGS WAREHOUSE WITH YOUR BUNNINGS REGISTER RECEIPT. PRIOR TO RETURNING YOUR PRODUCT FOR WARRANTY PLEASE TELEPHONE OUR CUSTOMER SERVICE HELPLINE:

Australia 1800 069 486

New Zealand 0508 069 486

TO ENSURE A SPEEDY RESPONSE PLEASE HAVE THE MODEL NUMBER AND DATE OF PURCHASE AVAILABLE. A CUSTOMER SERVICE REPRESENTATIVE WILL TAKE YOUR CALL AND ANSWER ANY QUESTIONS YOU MAY HAVE RELATING TO THE WARRANTY POLICY OR PROCEDURE.

The benefits provided under this warranty are in addition to other rights and remedies which are available to you at law.

Our goods come with guarantees that cannot be excluded at law. You are entitled to a replacement or refund for a major failure and for compensation for any other reasonably foreseeable loss or damage. You are also entitled to have the goods repaired or replaced if the goods fail to be of acceptable quality and the failure does not amount to a major failure.

Generally you will be responsible for all costs associated with a claim under this warranty, however, where you have suffered any additional direct loss as a result of a defective product you may be able to claim such expenses by contacting our customer service helpline above.

3 YEAR REPLACEMENT WARRANTY

Your product is guaranteed for a period of **36 months from the original date of purchase** and is intended for DIY (Do It Yourself) use only. If a product is defective it will be replaced in accordance with the terms of this warranty. Warranty excludes consumable parts, for example: grinding discs, carbon brushes, disc guard, flanges, paper washers, etc.

WARNING

The following actions will result in the warranty being void.

- If the tool has been operated on a supply voltage other than that specified on the tool.
- If the tool shows signs of damage or defects caused by or resulting from abuse, accidents or alterations.
- Failure to perform maintenance as set out within the instruction manual.
- If the tool is disassembled or tampered with in any way.

STANDARD EQUIPMENT

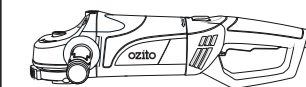

Angle Grinder



Cutting & Grinding Inner & Outer Flanges

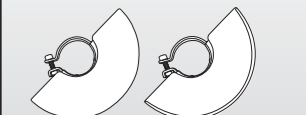

Cutting & Grinding Guard



10 x Paper Washers, Grinding Disc & Cutting Disc

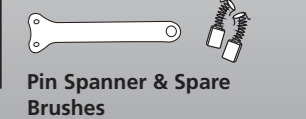

AGB-2200

KNOW YOUR PRODUCT

ANGLE GRINDER

- 1 Spindle Lock
- 2 Side Handle
- 3 Handle Rotation Button
- 4 Rear Handle
- 5 Grinding Disc
- 6 Guard Locking Lever
- 7 Grinding Guard
- 8 Safety Lock Off Trigger

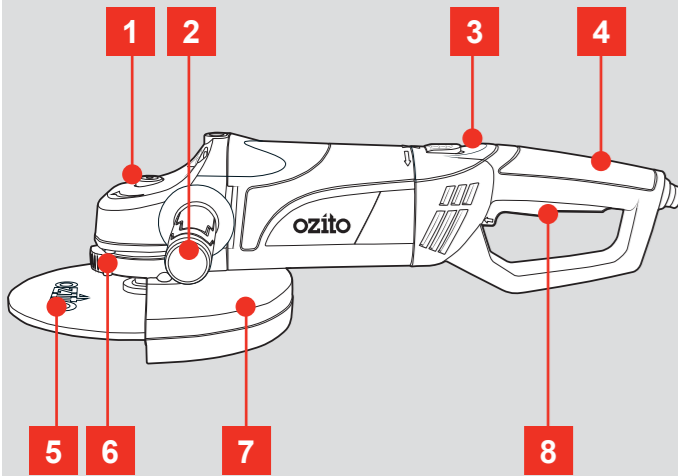

ACCESSORIES

- 9 Pin Spanner
- 10 Spare Carbon Brush Pair
- 11 Cutting Guard
- 12 Cutting Disc
- 13 Cutting Inner Flange (80mm)
- 14 Cutting Outer Flange (80mm)
- 15 Paper Washer x 10
- 16 Grinding Inner Flange
- 17 Grinding Outer Flange

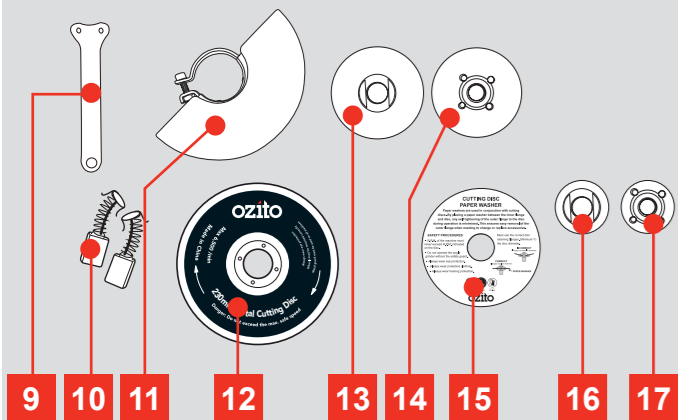

ONLINE MANUAL

Scan this QR Code with your mobile device to take you to the online manual.



SETUP & PREPARATION

1. HANDLES

WARNING! ENSURE THE TOOL IS SWITCHED OFF AND DISCONNECTED FROM THE POWER SUPPLY BEFORE PERFORMING ANY OF THE FOLLOWING TASKS.

Side Handle

The side handle can be fitted on both sides and the top of your grinder. The correct position will be determined by your preferred hand and the task.

Attaching

- 1 Firmly attach the side handle on the desired side of the grinder. Thread in clockwise.

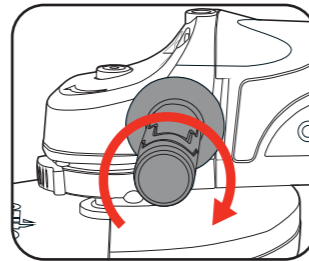

Removing

- 2 Remove side handle by turning anti-clockwise.

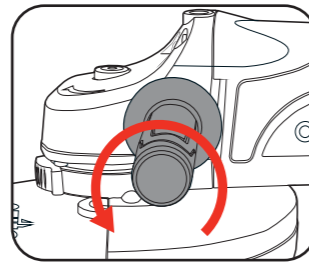

Rear Handle

WARNING! NEVER START THE TOOL WITH THE REAR HANDLE LOOSE. ENSURE IT IS SECURELY LOCKED IN POSITION BEFORE OPERATING.

The rear handle can be rotated to increase user comfort and to gain better access to hard to reach or confined places.

- 1 Pull back the handle rotation button.

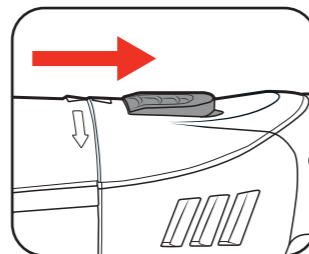

- 2 Rotate the rear handle 90° until it clicks into place.

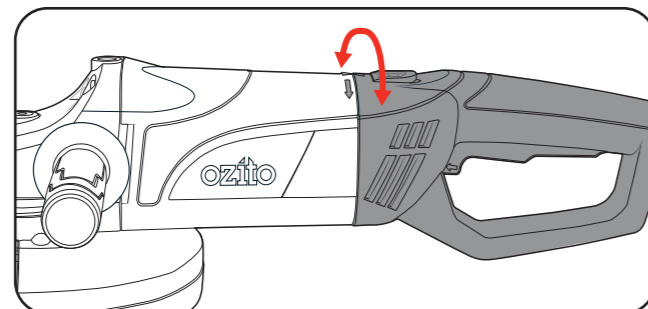

2. SAFETY GUARDS

WARNING! A SAFETY GUARD SHOULD BE USED AT ALL TIMES WHILST OPERATING THE ANGLE GRINDER.

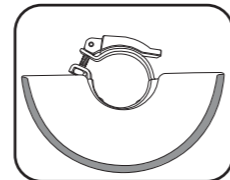

Use ONLY the semi-open Grinding Guard with a grinding disc.

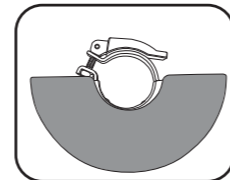

Use ONLY the fully enclosed Cutting Guard with a cutting disc.

Attaching

- 1 Release the guard lever and loosen guard nut.
- 2 Place guard on spindle neck by aligning the notches. Then rotate into the desired position.

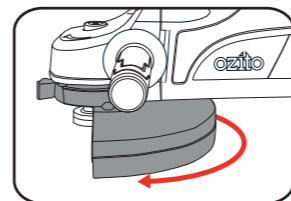
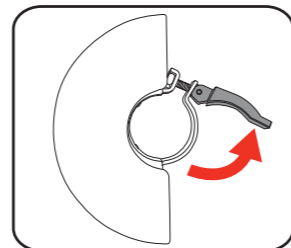

- 3 Tighten guard nut then close the guard lever.

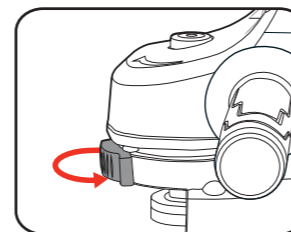

WARNING! IF THE GUARD NUT IS OVERTIGHTENED, THE GUARD LEVER WILL NOT BE ABLE TO CLOSE PROPERLY. IF THE GUARD NUT IS TOO LOOSE, THE GUARD LEVER WILL CLOSE BUT WILL NOT SECURELY FASTEN THE GUARD TO THE SPINDLE NECK.

Removing

- 1 Release the guard lever and loosen guard nut.
- 2 Align tabs on the guard with slots on the guard collar and then remove guard.

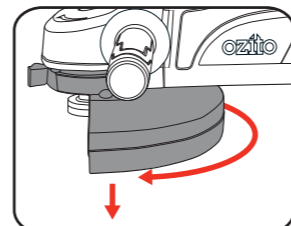
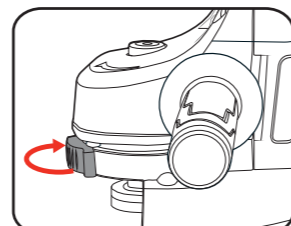

3. CHANGING DISCS

Removing

- 1 Depress and hold spindle lock button. Rotate the spindle to locate the lock position.
- 2 Use pin spanner to loosen the outer flange. Remove the inner and outer flange.

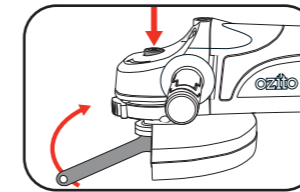
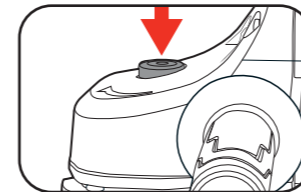

Fitting a Disc

Two sets of flanges are provided with your angle grinder to enable the fitment of a cutting or grinding disc. Ensure you use the correct flanges for the application. Paper washers are for use with cutting discs to prevent the outer flange from self tightening during operation.

WARNING! INSPECT THE DISC BEFORE FITMENT TO ENSURE IT IS NOT CRACKED OR DEFORMED. THE GRINDING DISC IS SUITABLE FOR GRINDING TASKS ONLY. ONLY USE DISCS WITH A DIAMETER OF 230MM.

- 1 Place the inner flange onto the spindle, ensuring the notches align with the grooves.
- 2 For grinding, insert the provided disc with the label facing up, (facing the grinder).

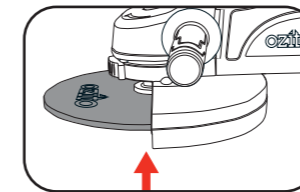
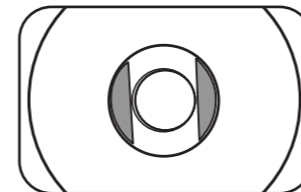

WARNING! FOR CUTTING, ENSURE A PAPER WASHER IS PLACED BETWEEN THE INNER FLANGE AND CUTTING DISC TO PREVENT SELF TIGHTENING DURING OPERATION.

- 3 Screw the outer flange onto the spindle. The direction of the outer flange differs for the cutting and grinding disc as shown below.

Note: Outer flanges are threaded, Inner flanges are not.

Cutting Disc:

The raised ring on the flange must face away from the cutting disc.

Grinding Disc:

The raised ring on the flange must locate within the hole on the grinding disc.

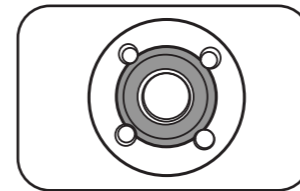
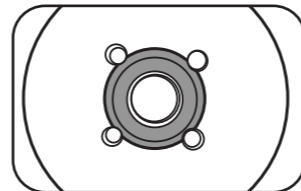

- 4 Depress and hold spindle lock button. Firmly tighten the outer flange with the pin spanner.

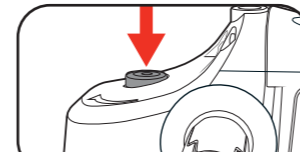

OPERATION

4. ON/OFF SWITCH

WARNING! TO REDUCE THE RISK OF ELECTRICAL SHOCK, THE USE OF A RESIDUAL CURRENT DEVICE (RATED 30mA OR LESS) IS RECOMMENDED.

- 1 To turn the grinder on, first push safety lock off trigger forward, then depress trigger. Hold the trigger switch in this position for continuous use.

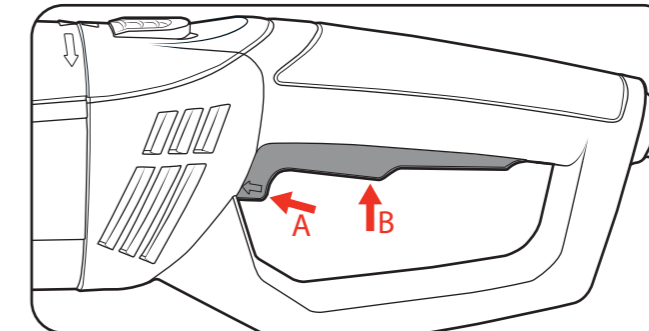

- 2 To turn the grinder off, release the trigger switch.

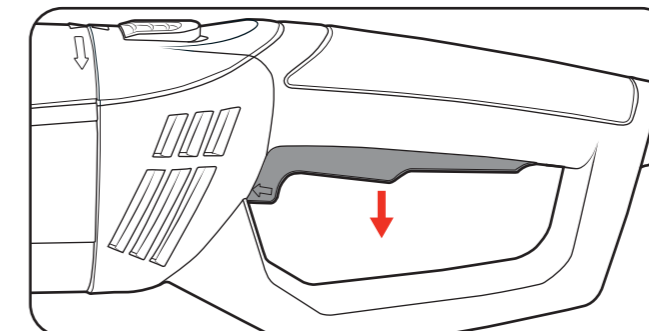

Note: The grinder is fitted with a soft-start switch for added safety.

5. GRINDING & CUTTING

- 1 Ensure the workpiece is securely held down.

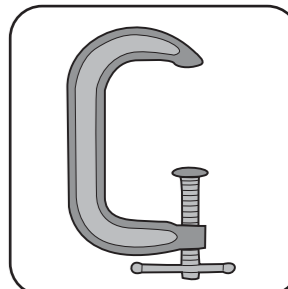

- 2 Turn on the angle grinder.

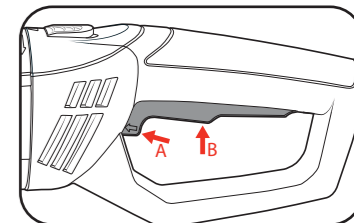

WARNING! REGULARLY CHECK THAT THE OUTER FLANGE HAS NOT BECOME LOOSE DURING OPERATION.

3a For grinding

The optimum angle is 10-15° to the workpiece. Do not apply excessive pressure. Allow the tool to do the work. This will prevent deep gouging.

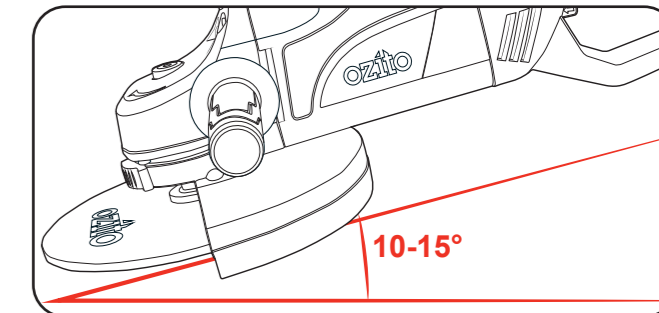

3b For cutting

The optimum angle is 90° to the workpiece. Do not apply excessive pressure. Allow the tool to do the work.

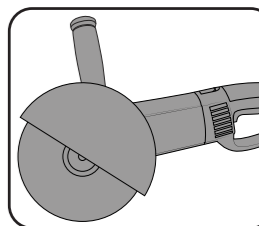

WARNING! GRINDING DISCS ARE FOR GRINDING APPLICATIONS ONLY. CUTTING DISCS ARE FOR CUTTING APPLICATIONS ONLY.