

Einhell®

© Original operating instructions
Petrol Lawn Mower

7

Art.-Nr.: 34.006.91

I.-Nr.: 11011

RG-PM

51 VS B&S



Ⓢ Read and follow the operating instructions and safety information before using for the first time.

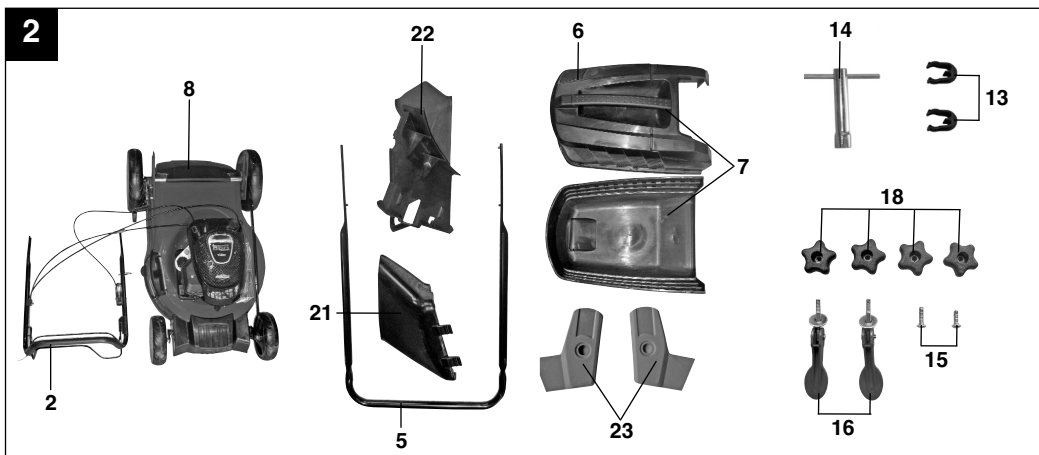
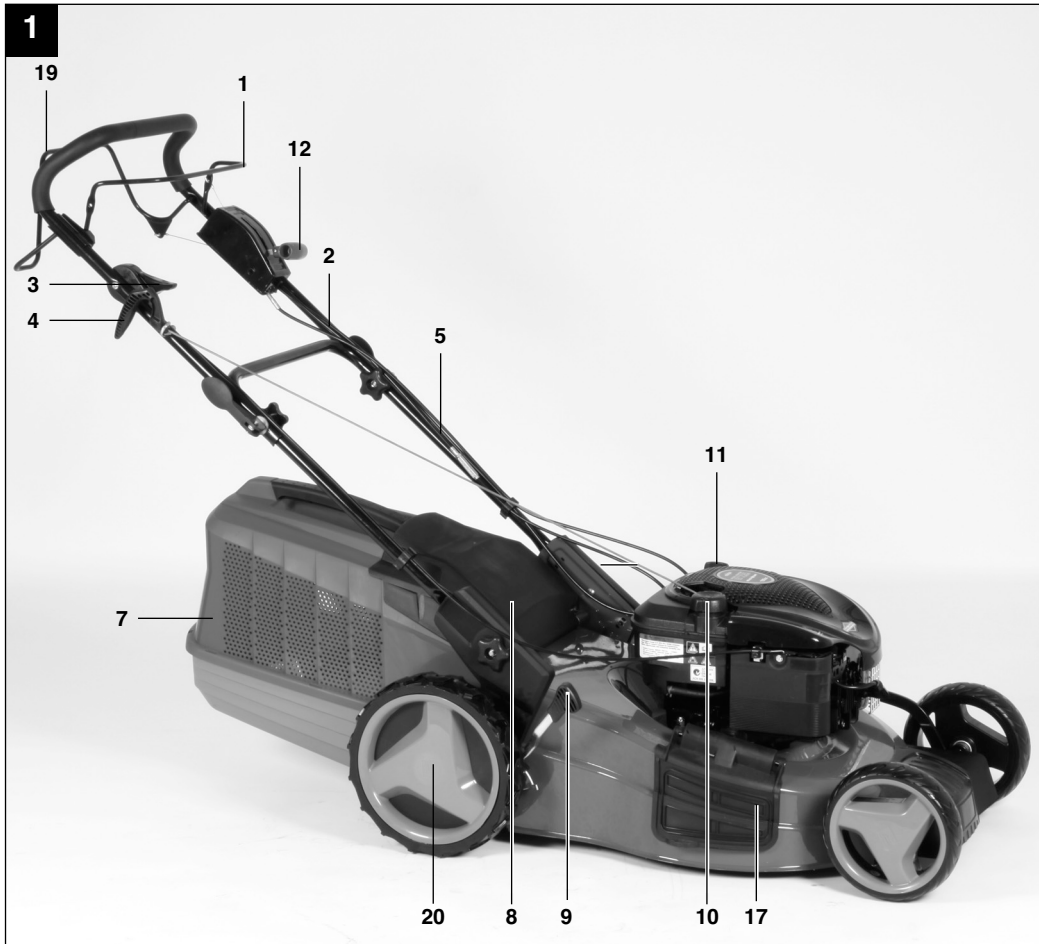

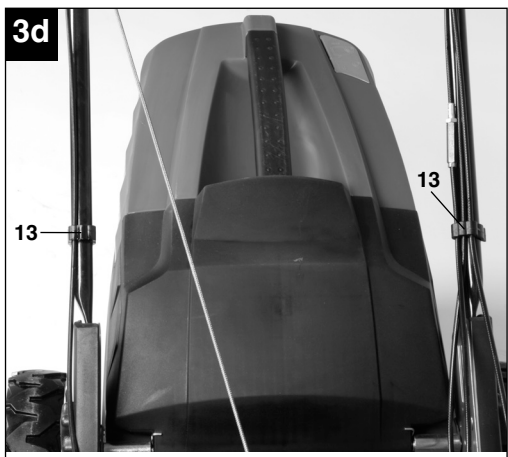
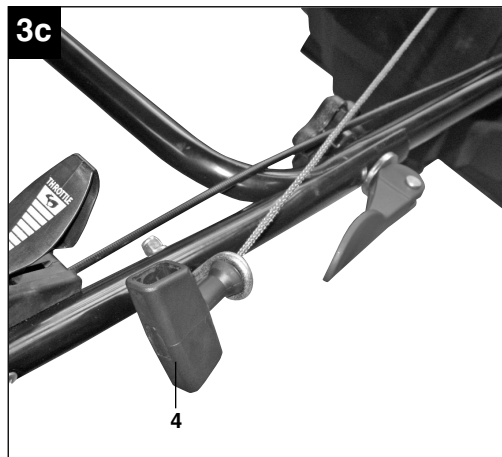
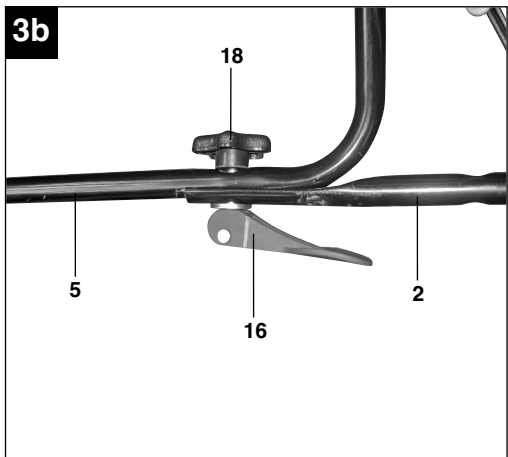
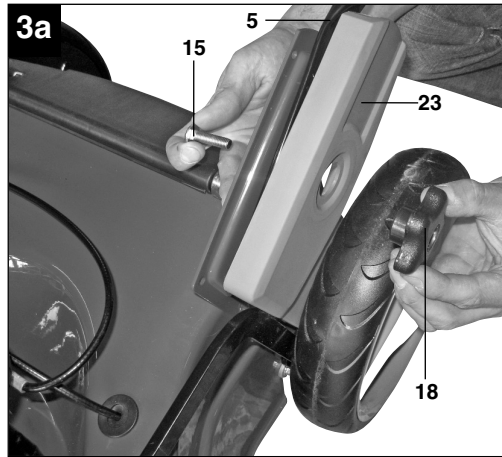
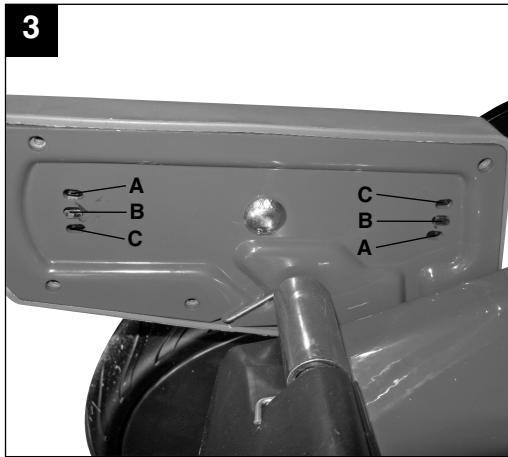

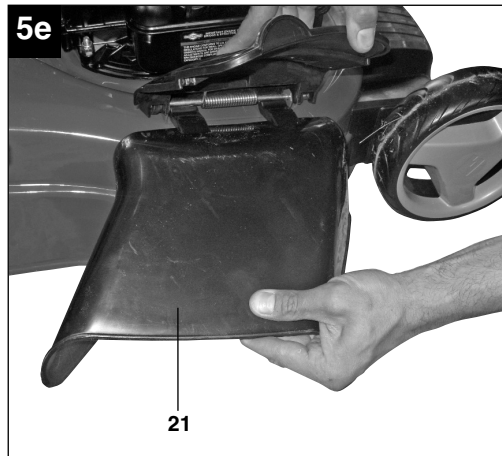
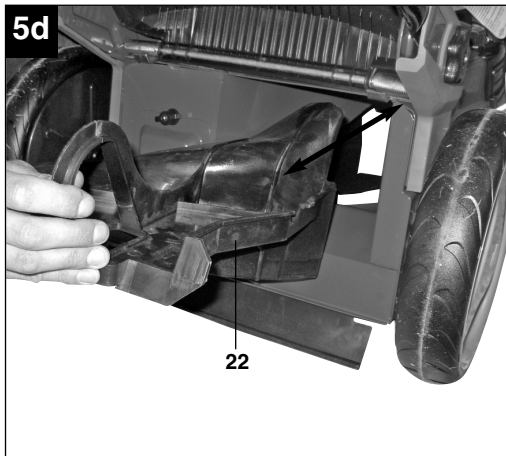
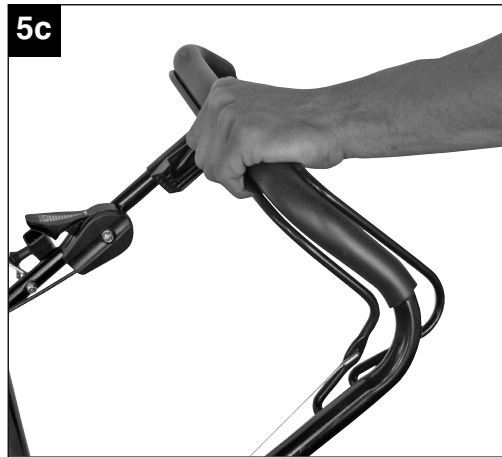
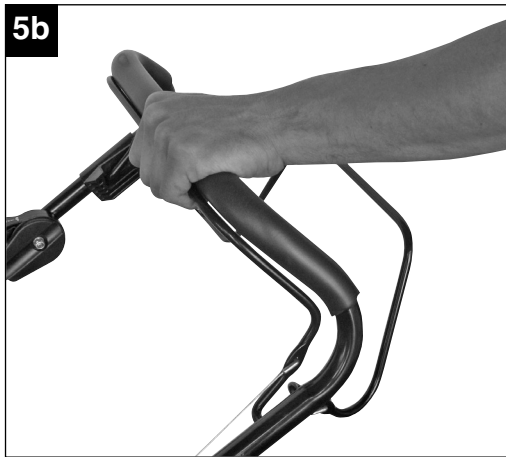
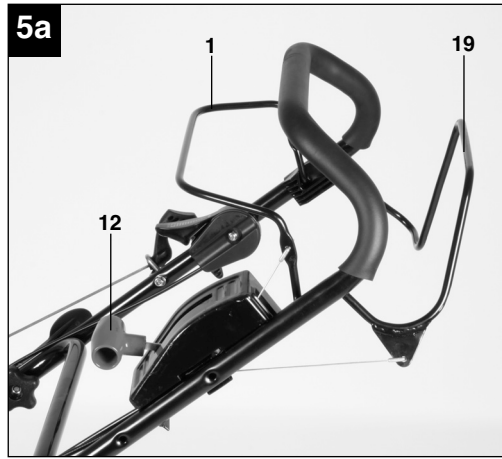
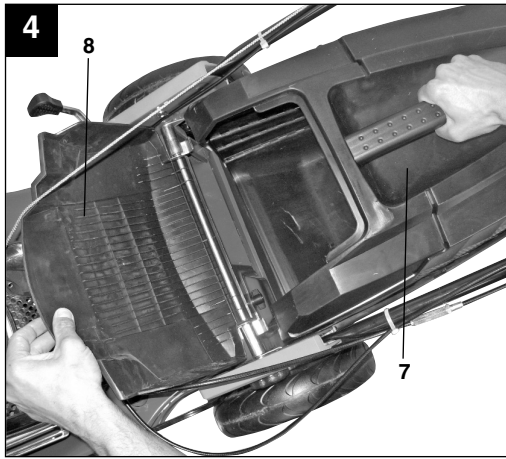

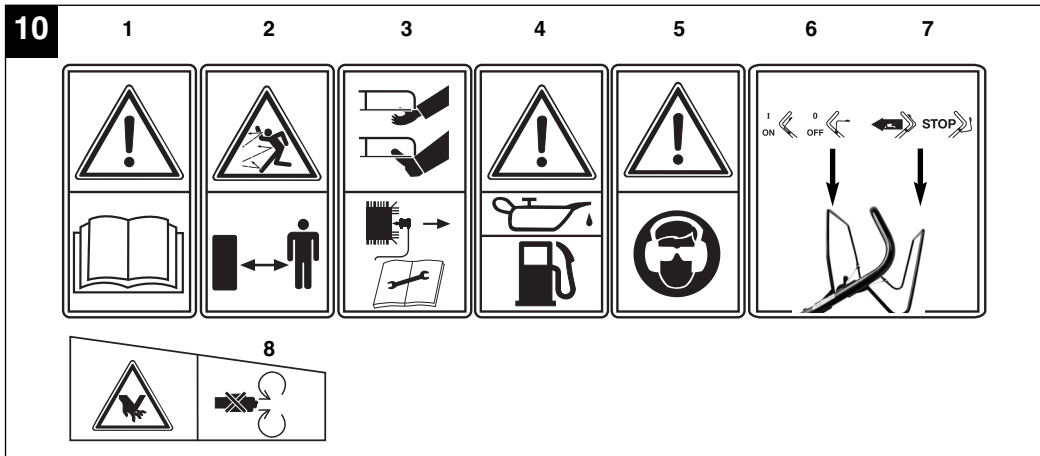
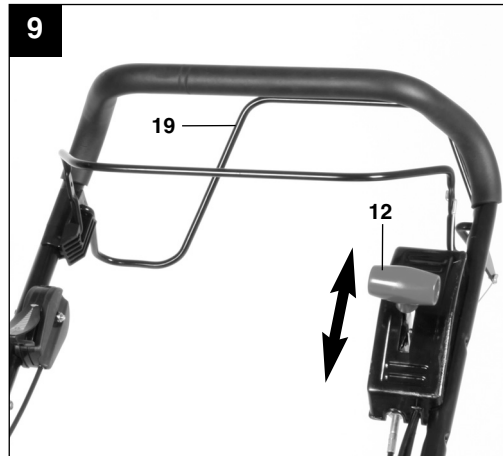
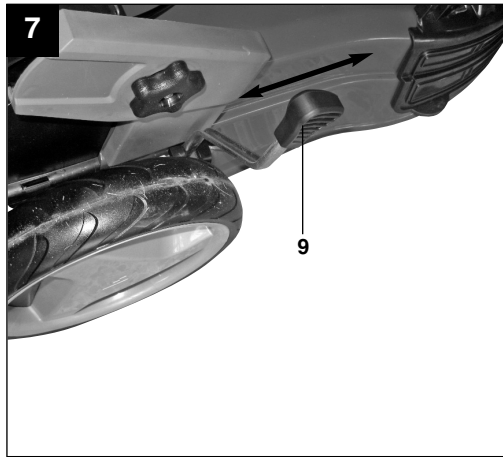

Table of contents:

1. Safety information
2. Layout
3. Items supplied
4. Intended use
5. Technical data
6. Before starting the equipment
7. Operation
8. Cleaning, maintenance, storage, transport and ordering of spare parts
9. Disposal and recycling
10. Troubleshooting guide

GB**⚠ Important!**

When using the equipment, a few safety precautions must be observed to avoid injuries and damage. Please read the complete operating instructions and safety regulations with due care. Keep this manual in a safe place, so that the information is available at all times. If you give the equipment to any other person, hand over these operating instructions and safety regulations as well. We cannot accept any liability for damage or accidents which arise due to a failure to follow these instructions and the safety instructions.

1. Safety instructions for hand-operated lawn mowers**Note**

1. Read the directions with due care. Familiarize yourself with the settings and proper operation of the machine.
2. Never allow children or other persons who are not familiar with the operating instructions to use the mower. Contact your local governmental agency for information regarding minimum age requirements for operating the mower.
3. Never mow in the direct vicinity of persons - especially children - or animals. Always keep in mind that the operator is responsible for accidents involving other persons and/or their property.
4. If you give the equipment to any other person, give them these operating instructions as well.

Preliminary measures

1. Always wear sturdy, non-slip footwear and long trousers when mowing. Never mow barefoot or in sandals.
2. Check the grounds on which the machine will be used and remove all objects that could be caught up and violently flung out of the chute.
3. **Warning:** Petrol is highly flammable! Therefore:
 - Only store petrol in containers designed to hold petroleum-based liquids.
 - Only refuel out in the open and do not smoke during the refueling process.
 - Always refuel the lawn mower *before* starting the engine. Always ensure that the fuel tank cap is closed when the engine is running and when the mower is hot; also do not refuel.
 - If petrol has overflowed, do not under any circumstances attempt to start the engine. Instead, remove the machine from the affected area. Avoid starting the engine until the petrol fumes have completely evaporated.
 - For safety reasons, the petrol tank and other

tank closures must be replaced if they are damaged.

4. Replace defective mufflers.
5. Before using the mower, visually inspect it to ensure that the blade, mounting bolts and the entire cutting apparatus are in good working order (i.e. not worn out or damaged). To prevent any imbalance, replace worn out or damaged blades and mounting bolts as a set only (if applicable).
6. Please note that where a mower has more than one blade, the rotation of one of the blades can cause the others to rotate as well.

Handling

1. Do not let the combustion engine run in enclosed areas, as dangerous carbon monoxide gas can build up.
2. Only mow in broad daylight or in well-lit conditions. Avoid using the machine on wet grass as far as possible.
3. Always maintain good footing on inclines.
4. Only operate the machine at a walking pace.
5. For machines with wheels: Always mow *across* hills i.e. never straight up or straight down.
6. Be particularly careful when you change direction on a slope.
7. Do not mow on overly steep inclines.
8. Always be extra careful when turning the mower around and when pulling it towards you.
9. Switch off the lawn mower and ensure that the blade has stopped rotating whenever the mower has to be tilted for transporting over areas other than lawns and whenever it has to be moved from or to the area you want to mow.
10. Never use the lawn mower if the blade or safety grilles are damaged, or without the attached guards, e.g. deflectors and/or grass catching devices.
11. Do not adjust or overclock the engine speed settings.
12. Release the engine brake before you start the engine.
13. Start the engine with care, in accordance with the manufacturer's instructions. Make sure that your feet are far enough away from the mower blade!
14. Do not tilt the lawn mower when you start the engine unless the mower must be raised off of the ground a little in order to start it. In the latter case, tilt the mower as little as absolutely necessary and only raise the side opposite to that of the user.
15. Never start the engine while standing in front of the chute.
16. Never move your hands or feet toward or under

any rotating parts. Keep clear of the chute opening at all times.

17. Never lift or carry a lawn mower with the engine running.
18. Switch off the engine and pull the spark plug boot:
 - before you dislodge any blockages or clogs in the chute.
 - before carrying out any checks, cleaning, maintenance or other work on the lawn mower
 - if the lawn mower strikes a foreign body, examine it for signs of damage and carry out any necessary repairs before restarting and continuing to work with the mower. If the lawn mower begins to experience exceptionally strong vibrations, immediately switch it off and check it.
19. Switch off the engine:
 - when you leave the lawn mower.
 - before you refuel.
20. When you switch off the engine, move the speed lever to the Off position. Close the petrol stopcock.
21. Operation of the machine at higher than normal speed can lead to an increased risk of accidents.
22. Take care when carrying out installation work on the machine, and avoid trapping fingers between the moving cutting tool and the fixed parts of the machine.

Maintenance and storage

1. Make sure that all nuts, bolts and screws are tightened securely and that the machine is in safe working condition.
2. Never store the mower (with petrol in the tank) inside a building in which petrol fumes could come into contact with open flames or sparks.
3. Allow the motor to cool before you put the lawn mower in an enclosed area.
4. In order to avoid fire hazards, keep the engine, exhaust and the area around the fuel tank free from grass, leaves and leaking grease (oil).
5. Routinely check the grass basket for signs of wear and impaired functionality.
6. For your own safety, replace worn or damaged parts without delay.
7. If the fuel tank should require emptying this should only be done in the open air using a petrol suction pump (available from DIY shops).

⚠ CAUTION!

Read all safety regulations and instructions.

Any errors made in following the safety regulations and instructions may result in an electric shock, fire and/or serious injury.

Keep all safety regulations and instructions in a safe place for future use.

Explanation of the symbols on the machine (fig. 10):

- 1) Read the operating instructions
- 2) Important! Danger from catapulted parts. Keep a safe distance.
- 3) Important! Switch off the engine and pull the spark plug boot before doing any maintenance, repair, cleaning or adjustment work.
- 4) Fill with oil and fuel before starting the mower.
- 5) Caution! Wear ear protection and safety goggles.
- 6) Engine start/stop lever (I=Engine on; 0=Engine off)
- 7) Drive lever (clutch lever)
- 8) Risk of cut injuries. Caution: rotating cutters.

2. Layout (Fig. 1-9)

1. Engine start/stop lever – engine brake
2. Top push bar
3. Throttle lever
4. Starter cable
5. Lower push bar
6. Filling level indicator debris bag
7. Debris bag
8. Ejector flap
9. Cutting height adjustment
10. Tank filler cap
11. Oil-filler neck
12. Speed adjuster lever
13. 2 x cable ties
14. Spark plug wrench
15. 2 x square head screws for top push bar
16. 2 screws for upper push bar with high speed clamping function
17. Side ejector cover
18. 4 x star nuts for push bar
19. Drive lever (clutch lever)
20. Drive wheel (left and right)
21. Side ejector adaptor
22. Mulching adaptor
23. Cover for lower push bar

3. Items supplied

Please check that the article is complete as specified in the scope of delivery. If parts are missing, please contact our service center at the latest within 5 work days after purchasing the article and upon presentation of a valid bill of purchase. Also, refer to the warranty table in the warranty provisions at the

GB

end of the operating instructions.

- Open the packaging and take out the equipment with care.
- Remove the packaging material and any packaging and/or transportation braces (if available).
- Check to see if all items are supplied.
- Inspect the equipment and accessories for transport damage.
- If possible, please keep the packaging until the end of the guarantee period.

IMPORTANT

The equipment and packaging material are not toys. Do not let children play with plastic bags, foils or small parts.

There is a danger of swallowing or suffocating!

- Petrol lawn mower
- Upper push bar and lower push bar
- Side ejector adaptor
- Mulching adaptor
- Grass basket (two-piece)
- Cover for the lower push bar (2x)
- Spark plug wrench
- Star nut (4x)
- Quick-tightening screw (2x)
- Square head screw (2x)
- Cable clip (2x)
- Petrol service manual
- Original operating instructions

4. Intended use

The equipment may only be used for the tasks it is designed to handle. Any other use is deemed to be a case of misuse. The user/operator and not the manufacturer will be liable for any damage or injuries of any kind caused as a result of this.

The petrol lawn mower is intended for private use i.e. for use in home and gardening environments.

Private use of the lawn mower refers an annual operating time generally not exceeding that of 50 hours, during which time the machine is primarily used to maintain small-scale, residential lawns and home/hobby gardens. Public facilities, sporting halls, and agricultural/forestry applications are excluded.

Please note that our equipment has not been designed for use in commercial, trade or industrial applications. Our warranty will be voided if the machine is used in commercial, trade or industrial

businesses or for equivalent purposes.

The operating instructions as supplied by the manufacturer must be kept and referred to in order to ensure that the lawn mower is properly used and maintained. The instructions contain valuable information on operating, maintenance and servicing conditions.

Important! Due to the high risk of bodily injury to the user, the lawn mower may not be used to trim bushes, hedges or shrubs, to cut scaling vegetation, planted roofs, or balcony-grown grass, to clean (suck up) dirt and debris off walkways, or to chop up tree or hedge clippings. Moreover, the lawn mower may not be used as a power cultivator to level out high areas such as molehills.

For safety reasons, the lawn mower may not be used as a drive unit for other work tools or toolkits of any kind.

5. Technical data

Note:

The enclosed manual from Briggs & Stratton provides detailed technical data on the engine!

Engine type:

Single cylinder four-stroke engine, 190 ccm

Working speed: 2800 min⁻¹

Fuel: standard petrol

Cutting height adjustment: central, (30-75 mm)

Cutting width: 510 mm

Speed

Setting 1 approx. 2.3 km/h

Setting 2 approx. 3.0 km/h

Setting 3 approx. 3.6 km/h

Setting 4 approx. 4.1 km/h

Weight: 41.8 kg

Sound and vibration

L_{pA} sound pressure level 87.8 dB(A)

K_{pA} uncertainty 2 dB

L_{WA} sound power level 98 dB(A)

K_{WA} uncertainty 2 dB

Wear ear-muffs.

The impact of noise can cause damage to hearing.
Vibration emission value $a_h = 6.36 \text{ m/s}^2$

K uncertainty = 1.5 m/s^2

6. Before starting the equipment**6.1 Assembling the components**

Some parts of the mower come disassembled. For quick and easy assembly, read and follow the instructions below.

Important! You will need the following additional tools (not supplied) for assembly, and also for maintenance work:

- A flat oil drip tray (for changing the oil)
- A 1 liter measuring jug (oil/petrol resistant)
- A petrol can
- A funnel (suitable for the tank's petrol filler neck)
- Household wipes (to wipe up oil/petrol residue; dispose of these at a filling station)
- A petrol suction pump (plastic, available from DIY stores)
- An oil can with hand pump (available from DIY stores)

Assembly

1. Affix the lower push bar (Fig. 3a/Item 5) to the mower housing and set the desired working height. 3 different working heights are available. Each peg on the lower push bar can be inserted into a hole situated directly opposite to it, on the mower housing, for example A-A (Fig. 3). The lower push bar must be equally adjusted on both sides. Now affix the cover (Fig. 3a/Item 23) and attach the push bar (5) using the square head screws (15) and the star screws (18) as shown in Figure 3a.
2. Fasten the top push bar to the bottom push bar using a screw (Fig. 3b/Item 16) and a star screw (Fig. 3b/Item 18) on each side. Make sure that the lobes of the screws are folded towards the inside so that the high speed clamping function remains operational.
3. Insert the grip of the starter cord (Fig. 3c/Item 4) into the hook provided for that purpose as shown in Figure 3c.
4. Fasten the cords to the push bar with the supplied cable ties (Fig. 3d/Item. 13).
5. The debris bag should be assembled as shown in Figure 3e. For this, insert the upper lugs of the debris bag carefully into the openings on the lower debris bag.
6. Lift the ejector flap (Fig. 4 / Item 8) with one hand

and hook in the grass bag (Fig. 4/Item 7) as shown in Figure 4

6.2 Setting the cutting height

Important! Adjust the cutting height only when the engine is switched off and the plug boot has been pulled.

- Before you begin to mow, check to ensure that the blade is not blunt and that none of the fasteners are damaged. To prevent any imbalance, replace blunt and/or damaged blades as a set only (if applicable). To carry out this check, first switch off the engine and pull the spark plug boot.
- The cutting height is centrally adjusted with the cutting height adjuster lever (Fig. 7/Item 9). Up to 5 different cutting heights can be selected.
- Pull the adjuster lever out and select the desired cutting height. The lever snaps into the desired position.

7. Operation**Note:**

For detailed information on starting the engine, refer to the enclosed manual from Briggs & Stratton.

Important.

The engine does not come with oil in it.

Therefore, be sure to add oil before starting the engine. You will also need to fill in petrol, as this is also not supplied upon delivery.

In order to avoid any unintentional start-ups of the lawn mower, it comes equipped with an engine brake (Fig. 5a/Item 1) which must be pulled back before the engine can be started. When the engine control lever is released it must return to its initial position, at which point the engine automatically switches off.

You can control the rotation speed of the blade using the speed lever (Fig. 6).

Before you start mowing, you should run through this operation several times in order to ensure that the machine is working properly.

Whenever you need to perform any kind of adjustment and/or repair work on your lawn mower, wait until the blade has come to a complete stop.

GB

Always switch off the engine before carrying out any adjustments, maintenance or repairs.

Note:

1. Engine brake (Fig. 5a/Item 1): Use the lever to stop the engine. When you release the lever the engine and the blade stop automatically (Fig. 5b). To mow, hold the lever in the working position. Before you start to mow, check the start/stop lever several times to be sure that it is working properly. Ensure that the tension cable can be smoothly operated (i.e. is not catching or kinking in any way).
2. Speed lever (Fig. 6): Move this lever in order to increase or decrease the engine speed. (Tortoise = Slow / Hare = Fast)
3. Drive lever (clutch lever) (Fig. 5a/Item 19): If you press this (Fig. 5c) the clutch for the drive will be closed and the lawnmower will start to move with the motor running.
Release the drive lever in good time to stop the moving lawnmower. Practice starting and stopping before you use the mower for the first time until you are familiar with controlling the mower.
4. **Caution:** The blade begins to rotate as soon as the engine is started.
Important:
Before you start the engine, move the motor brake several times to be sure that the stop cable is properly working. **Note:** The engine is factory set to a speed that is optimal for cutting and blowing grass into the basket and is designed to provide many years of use.
5. Check the oil level.
6. Fill the tank with petrol when it is empty, using a funnel and measuring vessel. Make sure that the petrol is clean.

Note: Use only unleaded petrol as fuel.

Warning: Never use more than one safety petrol can. Do not smoke when refueling. Switch off the engine before refueling and allow the engine to cool down for a few minutes.

Mulching

In the mulching mode the cuttings are shredded in the enclosed mower housing and then spread back onto the lawn. It is not necessary to gather and dispose of the grass.

Important: Mulching is only possible if the lawn is relatively short. Optimum results can be achieved only with a mulching blade (available as an accessory).

To use the mulching function, disconnect the debris bag, slide the mulching adaptor into the ejector opening (Fig. 5d/Item 22) and close the ejector opening.

Side ejector

You should fit the mulching adaptor (Item 22) in order to use the side ejector. Connect the side ejector adaptor (Fig. 5e/Item 21) as shown in Figure 5e.

Filling level indicator debris bag

The debris bag is equipped with a filling level indicator (Fig. 2/Item 6). This will be opened by the air current produced by the mower. If the flap falls during mowing, the debris bag is full and should be emptied. To ensure that the filling level indicator works properly, the holes under the flap must be kept clean and permeable.

Setting the speed (Vario Speed)

Up to 4 different speed settings can be selected. The slowest speed setting is setting 1, the fastest setting 4. To set the speed, move the lever (Fig. 9/Item 12) to the required position.

Important. The speed must only be set while the engine is running and the drive lever is actuated (Item 19).

7.1 Before mowing**Important information**

1. Make sure that you are properly dressed when mowing. Wear sturdy, non-slip footwear; do not wear sandals or tennis shoes.
2. Inspect the blade. A blade that is bent or damaged in any other way must be immediately exchanged for a genuine Einhell replacement blade.
3. Do not fill the fuel tank indoors, but rather out in the open. Use a filling funnel and a measuring jug. Wipe off any spilled petrol.
4. Read and follow in the instructions in the operating manual as well as the information regarding the engine and accessory equipment. Store the manual in a place where it can be readily accessed by other users of the machine.
5. Exhaust gas is dangerous. Only start the engine out in the open.
6. Make sure that all the guards are fitted and that they are in good working order.
7. The machine should only be operated by persons who are well informed with the way it works, and who are in reasonably good physical condition.
8. It can be dangerous to mow the grass when it is

wet. Try to ensure that you only mow the grass when it is dry.

9. Advise children and others to keep well away from the lawn mower.
10. Never mow the grass in poor visibility.
11. Remove all loose objects from the lawn before you start mowing the grass.

7.2 Tips for proper mowing

Important! Never open the chute flap when the catch bag has been detached (to be emptied) and the engine is still running. The rotating blade can cause serious injuries!

Always carefully fasten the chute flap and grass basket. Switch off the engine before emptying the grass basket.

Always ensure that a safe distance (provided by the length of the long handles) is maintained between the user and the mower housing. Be especially careful when mowing and changing direction on slopes and inclines. Maintain a solid footing and wear sturdy, non-slip footwear and long trousers. Always mow along the incline (not up and down).

For safety reasons, the lawn mower may not be used to mow inclines whose gradient exceeds 15 degrees. Use special caution when backing up and pulling the lawn mower. Tripping hazard!

7.3 Mowing

Only use a sharp blade that is in good condition. This will prevent the grass blades from fraying and the lawn from turning yellow.

Try to mow in straight lines for a nice, clean look. Insodoing, the mowing swaths should always overlap each other by a few centimeters in order to avoid bare strips.

Keep the underside of the mower housing clean and remove grass build-up. Deposits not only make it more difficult to start the mower; they decrease the quality of the cut and make it harder for the machine to bag the grass. Always mow along inclines (not up and down). Slightly turning the front wheels up the hill while mowing will prevent the mower from sliding out of the straight line. Select the cutting height according to the length of the grass. If the lawn has grown quite a bit, mow over it several times so that no more than 4 cm of grass are cut at one time.

Switch off the engine before doing any checks on the blade. Keep in mind that the blade continues to rotate for a few seconds after the engine has been switched off. Never attempt to manually stop the blade.

Regularly check to see if the blade is securely attached, is in good condition and is sharp. If the contrary is the case, sharpen the blade or replace it. In the event that the blade strikes an object, immediately switch off the lawn mower and wait for the blade to come to a complete stop. Then inspect the condition of the blade and the blade mount. Replace any parts that are damaged.

Tips for proper mowing:

1. Pay attention to ensure that you do not run into or over anything that could damage the mower. The lawn mower could be damaged and/or the machine could inflict bodily injury.
2. A hot engine, exhaust or drive unit can burn the skin if touched. Thus, do not touch these parts unless the mower has been switched off for a while and you know that they have cooled down!
3. Use extra caution when mowing on inclines and steep grades.
4. Insufficient daylight or even a sufficient level of artificial light is one reason not to mow.
5. Check the mower, the blade and other parts if they have struck a foreign object or if the machine vibrates more than usual.
6. Do not make any adjustments or repairs until the engine has been switched off. Pull the plug boot.
7. Pay special attention if you are mowing directly next to a street or are close by one (traffic). Always keep the grass chute pointed away from the street.
8. Avoid mowing in places where the wheels have trouble gripping or mowing is unsafe in any other way. Before you back up, ensure that nobody is standing behind you (especially little children, who are more difficult to see).
9. When mowing over thick, high grass, select the highest cutting level and mow at a slower speed. Before you remove any grass or blockages of any kind, switch off the engine and pull the plug boot.
10. Never remove any safety-related parts.
11. Never fill the engine with petrol when it is hot or is running.

GB**7.4 Emptying the grass basket**

As soon as grass clippings start to trail the lawn mower, it is time to empty the grass basket.

Important! Before taking off the grass basket, switch off the engine and wait until the blade has come to a stop.

To take off the grass basket, use one hand to lift up the chute flap and the other to grab onto the basket handle (Fig. 4). Remove the basket.

For safety reasons, the chute flap automatically falls down after removing the grass basket and closes off the rear chute opening. If any grass remains in the opening, it will be easier to restart the engine if you pull the mower back approx. 1 meter.

Do not use your hands or feet to remove clippings in or on the mower housing, but instead use suitable tools such as a brush or a hand broom.

In order to ensure that the majority of grass clippings are picked up, the inside of both the catch bag and especially the air grill must be cleaned after each use.

Reattach the catch bag only when the engine is switched off and the blade is stopped.

Using one hand, lift up the chute flap, while grabbing onto the basket handle with the other. Hang in the basket from the top.

7.5 After mowing

1. Allow the engine to cool before you put the lawn mower in an enclosed area.
2. Remove grass, foliage, grease and oil before storing the mower. Do not place any objects on top of the mower.
3. Check all the screws and nuts once more before you start to use the lawn mower again. Tighten any loose screws.
4. Also be sure to empty the grass basket.
5. Pull the spark plug boot to prevent unauthorized use.
6. Ensure that you do not park the mower next to any source of danger. Petrol fumes can lead to explosions.
7. Only original parts or parts approved by the manufacturer may be used for repairs (see address on the warranty certificate).
8. If the lawn mower is not going to be used for an extended period, empty the petrol tank using a petrol suction pump.
9. Tell your children not to use the mower. It is not a toy.
10. Never place petrol near an ignition source. Always use a can that is approved to store

petrol. Keep petrol away from children.

11. Oil and maintain the machine.

8. Cleaning, maintenance, storage, transport and ordering of spare parts

Important: The enclosed engine manual from Briggs & Stratton provides maintenance information and maintenance interval information on the engine.

Important:

Never work on or touch conducting parts on the ignition unit with the engine running. Always pull the spark plug boot from the spark plug before starting any work of care or maintenance. Never perform any work on the machine while it is running. Any work not described in these Operating Instructions must be performed by an authorized service workshop only.

8.1 Cleaning

After each use, the mower should be thoroughly cleaned (especially the underside and blade receptacle).

Note: Before you tilt the lawnmower onto its side, empty the fuel tank completely with a petrol pump. The lawnmower must not be tilted more than 90 degrees. The simplest time to remove dirt and grass is directly after mowing. Dried residual grass and dirt could cause damage to the mowing operation. Make sure the grass ejector canal is free from residual pieces of grass and remove these if necessary. Never clean the mower with a direct jet of water or a high pressure cleaner. The motor must stay dry. Aggressive cleaning agents such as cold cleaning solvent or petroleum ether must not be used.

8.2 Maintenance

Important: The enclosed engine manual from Briggs & Stratton provides maintenance information and maintenance interval information on the engine.

Dispose of soiled maintenance material and media at the appropriate collection point

8.2.1 Wheel axles and wheel hubs

These should be lightly greased once a season. To do so, remove the wheel caps with a screwdriver and slacken the fastening screws on the wheels.

8.2.2 Blade

For safety reasons you should only ever have your blade sharpened, balanced and mounted by an authorized service workshop. For optimum results it is recommended that the blade should be inspected once a year.

Changing the blade (Fig. 8)

Only ever use original spare parts when having the blade replaced. The marking on the blade must be matched with the number given in the list of spare parts. Never have any other model of blade fitted.

Damaged blades

Should the blade, in spite of all precautions, come into contact with an obstruction, shut down the engine immediately and pull the spark plug boot. Tip the lawn mower onto its side and check the blade for damage. Damaged or bent blades must be replaced. Never attempt to bend a bent blade back to straight again. Never mow the lawn with a bent or heavily worn blade as this will cause vibrations and can lead to further damage to the lawn mower.

Important: There is a risk of injury if you work with a damaged blade.

Resharpener the blade

The blades can be resharpened with a metal file. In order to avoid imbalance, the blade should be resharpened by an authorized service workshop.

8.2.3 Care and adjustment of the cables

Oil the cables at regular intervals and check that they move easily.

8.2.4 Inspecting the V-belt

To inspect the V-belt you must remove the V-belt cover (Fig. 8/Item D).

8.2.5 Repairs

After any repair or maintenance work, check that all safety-related parts are in place and in proper working order.

All parts which may cause injury must be kept where they are inaccessible to children or others.

Important: In accordance with product liability legislation we are not liable for any damages caused by improper repairs or the use of spare parts that are not original spare parts or parts approved by us. In addition, we are also not liable for any damages arising from improper repairs. Such work should be performed by a customer services workshop or authorized specialist. The same applies to accessory parts.

8.2.6 Times of use

Lawn mowers are only permitted to be used on workdays between the hours of 7.00 a.m. and 7.00 p.m. Please comply with statutory regulations, which may vary from location to location.

8.3 Preparing the mower for long-term storage

Caution: Do not empty the petrol tank in enclosed areas, near fire or when smoking. Petrol fumes can cause explosions and fire.

1. Empty the petrol tank with a petrol suction pump.
2. Start the engine and let it run until any remaining petrol has been used up.
3. Be sure to clean the entire machine to protect the paint.
4. Store the machine in a well-ventilated place.

8.4 Preparing the mower for transportation

1. Empty the petrol tank (see item 6.3.1).
2. Always let the engine run until it has used up the remainder of petrol in the tank.
3. Empty the engine oil from the warm engine.
4. Remove the spark plug boot from the spark plug.
5. Cleaning the equipment.
6. Remove the start tension cable from the hook (Fig. 3c). Slacken the wing nuts and fold down the upper push bar.
7. Wedge a few layers of corrugated cardboard between the upper and lower push bars and the engine in order to prevent any chafing.

8.5 Ordering replacement parts

Please quote the following data when ordering replacement parts:

- Type of machine
- Article number of the machine
- Identification number of the machine
- Replacement part number of the part required

For our latest prices and information please go to www.einhell.com.au

9. Disposal and recycling

The unit is supplied in packaging to prevent its being damaged in transit. This packaging is raw material and can therefore be reused or can be returned to the raw material system.

The unit and its accessories are made of various types of material, such as metal and plastic. Defective components must be disposed of as special waste. Ask your dealer or your local council.

GB**10. Faults and remedies for faults**

Caution: Always switch off the engine and pull the ignition cable before starting any inspection or adjustment work.

Caution: If, after making an adjustment or repair to the engine, you let it run for a few minutes, remember that the exhaust and other parts will get hot. Thus, do not touch parts that emanate heat, as these may burn you.

Important. If problems arise in connection with the engine, please refer to the enclosed manual from Briggs & Stratton.

Fault	Possible cause	Remedy
Loud while running, machine vibrates heavily	<ul style="list-style-type: none"> - Screws are loose - Blade fasteners are loose - Blade is unbalanced 	<ul style="list-style-type: none"> - Check screws - Check blade fasteners - Replace blade
Engine does not start	<ul style="list-style-type: none"> - Brake lever not pressed - Fuel tank is empty 	<ul style="list-style-type: none"> - Press brake lever - Refill with fuel
Uneven mowing results	<ul style="list-style-type: none"> - Blade is blunt - Cutting height is too low - Engine speed is too low 	<ul style="list-style-type: none"> - Sharpen the blade - Set correct height - Set lever to max.
Unsatisfactory bagging of the grass	<ul style="list-style-type: none"> - Engine speed is too low - Cutting height is too low - Blade is worn - Basket is clogged 	<ul style="list-style-type: none"> - Set speed lever to max. - Set correct height - Replace the blade - Empty the basket

Warranty conditions:

iSC GmbH guarantees the repair of defects or replacement of the equipment in accordance with the overview below, whereby statutory guarantee claims are not affected.

Category	Example	Warranty
Defect with regard to material or construction		24 months
Wear parts	Air filter, Bowden cables, grass basket, tires, drive clutch	6 months
Consumables	Blades	Warranty only in case of an immediate defect (24 hours after purchase / date on the bill)
Missing parts		5 work days

With regard to consumables, wear parts and missing parts iSC GmbH guarantees a correction of defects or a new delivery only if the defect is reported within 24 hours (consumables), 5 work days (missing parts) or 6 months (wear parts) after purchase and the purchase date is verified with the bill.

In case of defects concerning the material or construction, we kindly request you to submit the equipment together with the fully completed warranty card supplied with the equipment. It is important that you fill in an exact description of the defect.

To do so, answer the following questions:

- Did the equipment work at all or was it defective from the beginning?
- Did you notice anything (symptom or defect) prior to the failure?
- What malfunction does the equipment have in your opinion (main symptom)? Describe the malfunction.



GB GUARANTEE CERTIFICATE

Dear Customer,

All of our products undergo strict quality checks to ensure that they reach you in perfect condition. In the unlikely event that your device develops a fault, please contact our service department at the address shown on this guarantee card. Of course, if you would prefer to call us then we are also happy to offer our assistance under the service number printed below. Please note the following terms under which guarantee claims can be made:

1. These guarantee terms cover additional guarantee rights and do not affect your statutory warranty rights. We do not charge you for this guarantee.
2. Our guarantee only covers problems caused by material or manufacturing defects, and it is restricted to the rectification of these defects or replacement of the device. Please note that our devices have not been designed for use in commercial, trade or industrial applications. Consequently, the guarantee is invalidated if the equipment is used in commercial, trade or industrial applications or for other equivalent activities. The following are also excluded from our guarantee: compensation for transport damage, damage caused by failure to comply with the installation/assembly instructions or damage caused by unprofessional installation, failure to comply with the operating instructions (e.g. connection to the wrong mains voltage or current type), misuse or inappropriate use (such as overloading of the device or use of non-approved tools or accessories), failure to comply with the maintenance and safety regulations, ingress of foreign bodies into the device (e.g. sand, stones or dust), effects of force or external influences (e.g. damage caused by the device being dropped) and normal wear resulting from proper operation of the device.

The guarantee is rendered null and void if any attempt is made to tamper with the device.

3. The guarantee is valid for a period of 2 years starting from the purchase date of the device. Guarantee claims should be submitted before the end of the guarantee period within two weeks of the defect being noticed. No guarantee claims will be accepted after the end of the guarantee period. The original guarantee period remains applicable to the device even if repairs are carried out or parts are replaced. In such cases, the work performed or parts fitted will not result in an extension of the guarantee period, and no new guarantee will become active for the work performed or parts fitted. This also applies when an on-site service is used.
4. In order to assert your guarantee claim, please send your defective device postage-free to the address shown below. Please enclose either the original or a copy of your sales receipt or another dated proof of purchase. Please keep your sales receipt in a safe place, as it is your proof of purchase. It would help us if you could describe the nature of the problem in as much detail as possible. If the defect is covered by our guarantee then your device will either be repaired immediately and returned to you, or we will send you a new device.

Of course, we are also happy offer a chargeable repair service for any defects which are not covered by the scope of this guarantee or for units which are no longer covered. To take advantage of this service, please send the device to our service address.

EINHELL AUSTRALIA PTY LTD
6/166 Wellington Street
Collingwood VIC 3066
Australia
Phone: 1300 922 271

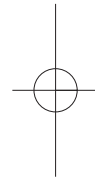
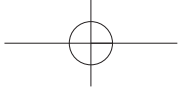

EH 06/2010 (01)

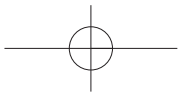

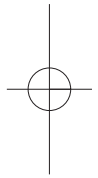
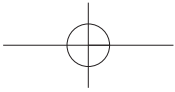

EH 06/2010 (01)

