

APPLICATIONS

8. CUTTING APPLICATIONS

Felling a tree

WARNING! FELLING A TREE SHOULD ONLY BE DONE BY TRAINED OPERATORS.

Decide the direction in which you wish the tree to fall, taking into account the direction of the wind, the position of branches, lean of the tree, ease of subsequent limbing and bucking and other factors prevalent at the time.

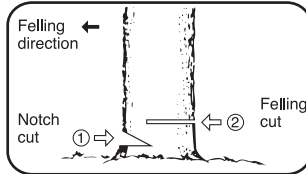

Limbing

WARNING! ALWAYS KEEP A BALANCED STANCE. DO NOT STAND ON THE LOG. BE ALERT TO THE FACT THAT THE LOG MAY ROLL OVER. WHEN WORKING ON A SLOPE, ALWAYS STAND ON THE UP HILL SIDE OF THE LOG.

Limbing is the process of removing the branches from a fallen tree. Check the direction in which a branch will bend before cutting it. Always cut on the opposite side to the bending direction so that the guide bar is not pinched in the cut. For large limbs that cannot be removed in one cut, make an initial cut from the bent side and finish by sawing from the opposite direction. Do not remove limbs that are supporting the fallen tree on the ground until the tree has been cut into lengths.

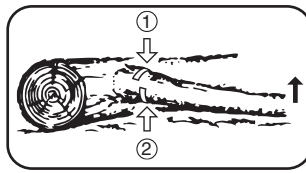

Bucking

Bucking is cutting a log into lengths for easier handling. To saw a log lying on the ground, first saw halfway, then roll the log over and cut from the opposite side.

To saw the end of a log supported off the ground, first saw up from the bottom one-third through the log then finish by sawing down from the top. To saw a log in the middle of two supports holding it off the ground, first saw down from the top one-third through the log then finish by sawing up from the bottom.

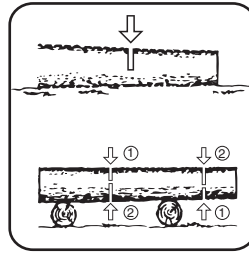

CAUTION! AVOID CUTTING INTO THE GROUND AS THIS WILL VERY QUICKLY DULL THE CHAIN.

Pruning

WARNING! DO NOT USE AN UNSTABLE FOOT. HOLD OR LADDER. DO NOT OVERREACH. DO NOT SAW ABOVE SHOULDER HEIGHT. ALWAYS USE BOTH HANDS TO HOLD THE SAW. FIRST CUT UP FROM THE BOTTOM AND FINISH DOWN FROM THE TOP.

Pruning is the removal of a limb or branch from a standing tree.

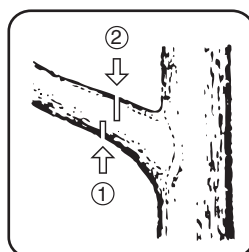

MAINTENANCE

WARNING! ENSURE THE CHAINSAW IS TURNED OFF & DISCONNECTED FROM THE POWER SUPPLY BEFORE PERFORMING ANY OF THE FOLLOWING OPERATIONS.

Chain tension

Check the chain tension frequently and adjust as often as necessary. (see **Tensioning the chain**)

Maintaining the guide bar

- Remove any sawdust from the guide bar, including the groove. Oil and sawdust combine and emit a burning smell during operation if the blade is not regularly cleaned.
- Make sure that the oil port is not clogged. Grease the nose sprocket at the tip of the guide bar.
- Check for oil leakage and loose fastenings, especially those securing the handles and the guide bar.
- Clean any dust away from the cooling vents as clogged vents can cause overheating. By maintaining a clean unit you will extend the useful life of the chain and the tool in general.

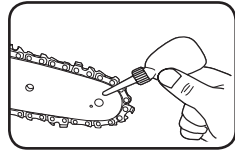

Chain Sharpening

Chain File: 3.96mm (5/32")

Chain Pitch: 9.53mm (3/8")

Chain Gauge: 1.3mm (0.050")

Sharpen the chain regularly to maintain optimum performance of the saw. Signs of a dull chain are:

- The sawdust becomes powder-like
- Extra force is required to execute a cut
- The cut does not track in a straight line
- Increased vibration

Sharpen each cutter using a chain file. Always use outward strokes and maintain a 30° angle between the chain and file. After sharpening, the cutters must all have the same width and length.

After every 3 – 4 uses get an authorised repair centre to professionally sharpen your chain. They have the special tools necessary to ensure the correct cutting angles and depths.

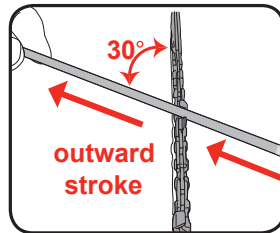

WARNING! WEAR HEAVY GLOVES WHEN HANDLING THE CHAIN. HOLD THE GUIDE BAR SECURELY IN A VICE.

Cleaning and storing

- Keep the handles free of grease so that you can maintain a firm grip.
- Clean the device as required with a damp cloth and, if necessary, mild washing up liquid.
- If the chainsaw is not to be used for an extended period of time then you should remove the chain oil from the tank. Briefly immerse the chain and the cutter rail in an oil bath and then wrap them in oil paper.

CAUTION! ALWAYS DISCONNECT THE MAINS PLUG BEFORE CLEANING THE CHAINSAW.

CAUTION! NEVER IMMERSE THE UNIT IN WATER OR OTHER LIQUIDS IN ORDER TO CLEAN IT.

CAUTION! STORE THE CHAINSAW IN A SAFE AND DRY PLACE OUT OF THE REACH OF CHILDREN.

SPARE PARTS

Spare parts can be ordered from the Special Orders Desk at your local Bunnings Warehouse or Homebase store. For further information, or any parts visit www.ozito-diy.co.uk or contact Ozito Customer Service: Great Britain: 0151 294 4488 Ireland: 1850 882711 E-mail: info@ozito-diy.co.uk

DESCRIPTION OF SYMBOLS

V	Volts	Hz	Hertz
~	Alternating current	W	Watts
/min	Revolutions or reciprocation per minute	no	No load speed
⚠	Warning	□	Safety class II
👁	Wear safety goggles.	👂	Wear ear protection
🚫	Never expose the device to rain	📖	Read the operating instructions.
⚡	If the cable is damaged or cut, disconnect the power plug from the mains immediately.		
→	Maximum cutting length / chain speed v_c : 13.5 m/s		

ADDITIONAL INFORMATION

Danger!

Sound and vibration

Sound and vibration values were measured in accordance with EN 60745.

L_{PA} sound pressure level85dB(A)

K_{PA} uncertainty3dB

L_{WA} sound power level105dB(A)

K_{WA} uncertainty2.55dB

Wear ear-muffs

The impact of noise can cause damage to hearing. Total vibration values (vector sum of three directions) determined in accordance with EN 60745.

Handle under load

Vibration emission value a_h = 5.781 m/s²

K uncertainty = 1.5 m/s²

The specified vibration value was established in accordance with a standardized testing method. It may change according to how the electric equipment is used and may exceed the specified value in exceptional circumstances.

The specified vibration value can be used to compare the equipment with other electric power tools.

The specified vibration value can be used for initial assessment of a harmful effect.

Keep the noise emissions and vibrations to a minimum.

- Only use appliances which are in perfect working order.
- Service and clean the appliance regularly.
- Adapt your working style to suit the appliance.
- Do not overload the appliance.
- Have the appliance serviced whenever necessary.
- Switch the appliance off when it is not in use.
- Wear protective gloves.

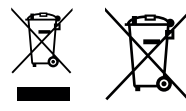

For EU countries only

Never place any electric power tools in your household refuse.

To comply with European Directive 2012/19/EC concerning old electric and electronic equipment and its implementation in national laws, old electric power tools have to be separated from other waste and disposed of in an environment-friendly fashion, e.g. by taking to a recycling depot.

Recycling alternative to the return request:

As an alternative to returning the equipment to the manufacturer, the owner of the electrical equipment must make sure that the equipment is properly disposed of if he no longer wants to keep the equipment. The old equipment can be returned to a suitable collection point that will dispose of the equipment in accordance with the national recycling and waste disposal regulations. This does not apply to any accessories or aids without electrical components supplied with the old equipment.

- The product meets the requirements of EN 61000-3-11 and is subject to special connection conditions. This means that use of the product at any freely selectable connection point is not allowed.
- Given unfavourable conditions in the power supply the product can cause the voltage to fluctuate temporarily.
- The product is intended solely for use at connection points that a) do not exceed a maximum permitted mains system impedance of $Z_{sys} = 0.3 \Omega$, or b) have a continuous current-carrying capacity of the mains of at least 100 A per phase.
- As the user, you are required to ensure, in consultation with your electric power company if necessary, that the connection point at which you wish to operate the product meets one of the two requirements, a) or b), named above.

SERVICE INFORMATION

We have competent service partners in all countries named on the guarantee certificate whose contact details can also be found on the guarantee certificate. These partners will help you with all service requests such as repairs, spare and wearing part orders or the purchase of consumables.

Please note that the following parts of this product are subject to normal or natural wear and that the following parts are therefore also required for use as consumables.

Category	Example
Wear parts*	Cutter bar, carbon brushes
Consumables	Saw chain
Missing parts	

* Not necessarily included in the scope of delivery!

In the event of defects or faults, please register the problem on the internet at www.isc-gmbh.info. Please ensure that you provide a precise description of the problem and answer the following questions in all cases:

- Did the equipment work at all or was it defective from the beginning?
- Did you notice anything (symptom or defect) prior to the failure?
- What malfunction does the equipment have in your opinion (main symptom)? Describe this malfunction.

ELECTRICAL SAFETY

WARNING! When using mains-powered tools, basic safety precautions, including the following, should always be followed to reduce risk of fire, electric shock, personal injury and material damage. Read the whole manual carefully and make sure you know how to switch the tool off in an emergency, before operating the tool. Save these instructions and other documents supplied with this tool for future reference. The manufacturer cannot accept any liability for damage or accidents which arise due to a failure to follow these instructions and the safety information. Before you connect the equipment to the mains supply make sure that the data on the rating plate are identical to the mains data.

This tool is double insulated therefore no earth wire is required.

GENERAL POWER TOOL SAFETY WARNINGS

WARNING! Read all safety warnings, instructions, illustrations and specifications provided with this power tool. Failure to follow the warnings and instructions may result in electric shock, fire and/or serious injury. Save all warnings and instructions for future reference. The term "power tool" in the warnings refers to your mains-operated (corded) power tool or battery-operated (cordless) power tool.

- Work area safety**
 - Keep work area clean and well lit. Cluttered or dark areas invite accidents.
 - Do not operate power tools in explosive atmospheres, such as in the presence of flammable liquids, gases or dust. Power tools create sparks which may ignite the dust or fumes.
 - Keep children and bystanders away while operating a power tool. Distractions can cause you to lose control.
- Electrical safety**
 - Power tool plugs must match the outlet. Never modify the plug in any way. Do not use any adapter plugs with earthed (grounded) power tools. Unmodified plugs and matching outlets will reduce risk of electric shock.
 - Avoid body contact with earthed or grounded surfaces, such as pipes, radiators, ranges and refrigerators. There is an increased risk of electric shock if your body is earthed or grounded.
 - Do not expose power tools to rain or wet conditions. Water entering a power tool will increase the risk of electric shock.
 - Do not abuse the cord. Never use the cord for carrying, pulling or unplugging the power tool. Keep cord away from heat, oil, sharp edges or moving parts. Damaged or entangled cords increase the risk of electric shock.
 - When operating a power tool outdoors, use an extension cord suitable for outdoor use. Use of a cord suitable for outdoor use reduces the risk of electric shock.
 - If operating a power tool in a damp location is unavoidable, use a residual current device (RCD) protected supply. Use of an RCD reduces the risk of electric shock.
- Personal safety**
 - Stay alert, watch what you are doing and use common sense when operating a power tool. Do not use a power tool while you are tired or under the influence of drugs, alcohol or medication. A moment of inattention while operating power tools may result in serious personal injury.
 - Use personal protective equipment. Always wear eye protection. Protective equipment such as dust mask, non-skid safety shoes, hard hat, or hearing protection used for appropriate conditions will reduce personal injuries.
 - Prevent unintentional starting. Ensure the switch is in the off-position before connecting to power source and/or battery pack, picking up or carrying the tool. Carrying power tools with your finger on the switch or energising power tools that have the switch on invites accidents.

The power supply for this product should be protected by a residual current device (rated at 30mA or less). A residual current device reduces the risk of electric shock.

If the supply cord is damaged, it must be replaced by an electrician or a power tool repairer in order to avoid a hazard.

Note: Double insulation does not take the place of normal safety precautions when operating this tool. The insulation system is for added protection against injury resulting from a possible electrical insulation failure within the tool.

Using an Extension Lead
Always use an approved extension lead suitable for the power input of this tool. Before use, inspect the extension lead for signs of damage, wear and ageing. Replace the extension lead if damaged or defective. When using an extension lead on a reel, always unwind the lead completely. Use of an extension lead not suitable for the power input of the tool or which is damaged or defective may result in a risk of fire and electric shock.

- Remove any adjusting key or wrench before turning the power tool on. A wrench or a key left attached to a rotating part of the power tool may result in personal injury.
 - Do not overreach. Keep proper footing and balance at all times. This enables better control of the power tool in unexpected situations.
 - Dress properly. Do not wear loose clothing or jewellery. Keep your hair, clothing and gloves away from moving parts. Loose clothes, jewellery or long hair can be caught in moving parts.
 - If devices are provided for the connection of dust extraction and collection facilities, ensure these are connected and properly used. Use of dust collection can reduce dust-related hazards.
 - Do not let familiarity gained from frequent use of tools allow you to become complacent and ignore tool safety principles. A careless action can cause severe injury within a fraction of a second.
- Power tool use and care**
 - Do not force the power tool. Use the correct power tool for your application. The correct power tool will do the job better and safer at the rate for which it was designed.
 - Do not use the power tool if the switch does not turn it on and off. Any power tool that cannot be controlled with the switch is dangerous and must be repaired.
 - Disconnect the plug from the power source and/or remove the battery pack, if detachable, from the power tool before making any adjustments, changing accessories, or storing power tools. Such preventive safety measures reduce the risk of starting the power tool accidentally.
 - Store idle power tools out of the reach of children and do not allow persons unfamiliar with the power tool or these instructions to operate the power tool. Power tools are dangerous in the hands of untrained users.
 - Maintain power tools and accessories. Check for misalignment or binding of moving parts, breakage of parts and any other condition that may affect the power tool's operation. If damaged, have the power tool repaired before use. Many accidents are caused by poorly maintained power tools.
 - Keep cutting tools sharp and clean. Properly maintained cutting tools with sharp cutting edges are less likely to bind and are easier to control.
 - Use the power tool, accessories and tool bits etc. in accordance with these instructions, taking into account the working conditions and the work to be performed. Use of the power tool for operations different from those intended could result in a hazardous situation.
 - Keep handles and grasping surfaces dry, clean and free from oil and grease. Slippery handles and grasping surfaces do not allow for safe handling and control of the tool in unexpected situations.
 - Service**
 - Have your power tool serviced by a qualified repair person using only identical replacement parts. This will ensure that the safety of the power tool is maintained.

SPECIAL SAFETY INSTRUCTIONS FOR CHAINSAWS

When the chainsaw is running make sure that you keep all parts of your body away from the chainsaw. Before starting up the chainsaw make sure that it is not touching anything. When you are working with a chainsaw, a single moment of carelessness is all it takes for clothing or parts of your body to get caught by the chainsaw.

Always hold the chainsaw securely with your right hand on the rear handle and your left hand on the front handle. Holding the chainsaw with your hands in other positions increases the risk of injury and is therefore not allowed.

Hold the appliance only by the insulated handles when carrying out work during which the cutting tool could strike concealed power cables or its own cable. Contact with a live cable will also make the metal parts of the appliance live and will cause an electric shock.

Wear safety goggles and ear protection. Other safety equipment for the head, hands, legs and feet is recommended. Correct protective clothing reduces the risk of injury caused by cuttable chips or in the event of accidental contact with the chainsaw.

Never use the chainsaw up a tree. You risk injuring yourself if you use the chainsaw up a tree.

Always maintain a steady standing position and only use the chainsaw when you are standing on a solid, safe and flat surface. Slippery or unsafe surfaces in combination with a ladder can cause you to lose your balance and control over the chainsaw.

When cutting through a branch which is under tension, take into account how it will spring back once the cut has been made. Once the tension in the wood fibres is released, the tensioned branch could hit the operator and/or seize control of the chainsaw.

Take special care when cutting undergrowth and young trees. The thin material can become caught in the saw chain and whip back towards you or make you lose your balance.

Carry the chainsaw by the front handle with the chainsaw switched off and the chain facing away from the body. Always fit the protective cover when transporting the chainsaw or putting it into storage.

Careful handling of the chainsaw reduces the likelihood of accidental contact with the saw chain while it is running.

Follow the instructions for lubrication, chain tension and replacement of accessories. A chain which is not properly tensioned or lubricated can either break or increase the risk of kickback.

Keep the handles dry, clean and free from oil and grease. Greasy or oily handles are slippery and will result in loss of control.

Only use the chainsaw to cut wood. The chain must only be used to perform the work for which it is intended. For example: Never use the chainsaw to cut plastic or brickwork or building materials which are not made of wood. Use of the chainsaw for non-intended or non-approved work can create dangerous situations.

Causes of ways to avoid recoil

Recoil can occur if the tip of the chain bar touches an item or if the wood bends and jams the saw chain in the cut.

In many cases contact with the bar tip can result in an unexpected reaction aimed backwards in which the chain bar is catapulted upwards towards the operator. Jamming the saw chain on the top of the chain bar can catapult the bar towards the operator at high speed.

ozito

ELECTRIC CHAINSAW

2000W 406mm

ORIGINAL INSTRUCTIONS

SPECIFICATIONS

Power rating:	2000W
Mains voltage:	230V-240V-50Hz
Idling speed:	7800 rpm
Cutting rail length:	406mm
Cutting length max.:	375mm
Cutting speed at rated rpm:	13.5m/s
Oil tank capacity:	160ml
Protection class:	II
Weight:	6.52kg

ozito-diy.co.uk



3 YEAR REPLACEMENT WARRANTY

WARRANTY

All of our products undergo strict quality checks to ensure that they reach you in perfect condition. In the unlikely event that your device develops a fault, please contact our service department at the address shown on this guarantee card. You can also contact us by telephone using the customer service number shown. Please note the following terms under which guarantee claims can be made:

1. These warranty terms regulate additional warranty services, which the manufacturer mentioned below promises to buyers of its new products in addition to their statutory guarantee claims are not affected by this guarantee. Our guarantee is free of charge to you.

2. The warranty services only covers defects due to material or manufacturing faults on a product which you have bought from the manufacturer mentioned below are limited to either the rectification of said defects on the product or the replacement of the product, whichever we prefer.

Please note that our devices are not designed for use in commercial, trade or professional applications. A guarantee contract will not be created if the device has been used by commercial, trade or industrial business or has been exposed to similar stresses during the guarantee period.

3. The following are not covered by our guarantee:

- Damage to the device caused by a failure to follow the assembly instructions or due to incorrect installation, a failure to follow the operating instructions (for example connecting it to an incorrect mains voltage or current type) or a failure to follow the maintenance and safety instructions or by exposing the device to abnormal environmental conditions or by lack of care and maintenance.
- Damage to the device caused by abuse or incorrect use (for example overloading the device or the use of unapproved tools or accessories), ingress of foreign bodies into the device (such as sand, stones or dust, transport damage), the use of force or damage caused by external forces (for example by dropping it).
- Damage to the device or parts of the device caused by normal or natural wear or tear or by normal use of the device.

4. Your Product is guaranteed for a period of 36 months from the original date of purchase and is intended for DIY (Do It Yourself) use only. Warranty excludes consumable parts. Guarantee claims should be submitted before the end of the guarantee period within two weeks of the defect being noticed. No guarantee claims will be accepted after the end of the guarantee period. The original guarantee period remains applicable to the device even if repairs are carried out or parts are replaced. In such cases, the work performed or parts fitted will not result in an extension of the guarantee period, and no new guarantee will become active for the work performed or parts fitted. This also applies if an on-site service is used.

IN ORDER TO MAKE A CLAIM UNDER THIS WARRANTY YOU MUST RETURN THE PRODUCT TO THE PLACE OF PURCHASE WITH YOUR REGISTER RECEIPT.

Please refer to the restrictions of this warranty concerning wearing parts, consumables and missing parts as set out in the service information in these operating instructions.

CUSTOMER SERVICE HELPLINE

GB: 0151 294 4488

IRL: 1850 882711

Ozito-diy.co.uk

WHAT'S IN THE BOX

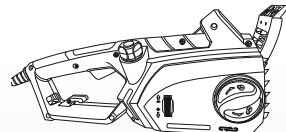

Electric Chainsaw

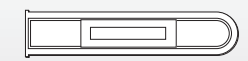

Guide Bar Cover



Chain



Guide Bar

ECS-2040U

KNOW YOUR PRODUCT

ELECTRIC CHAINSAW

1. Power cord
2. Cord retainer
3. Oil level window
4. Oil tank cap
5. Side cover
6. Chain tensioning dial
7. Side cover lock
8. Guide bar
9. Chain
10. Bucking spikes
11. Chain brake
12. Front handle
13. Lock-off switch
14. On/Off trigger
15. Rear handle

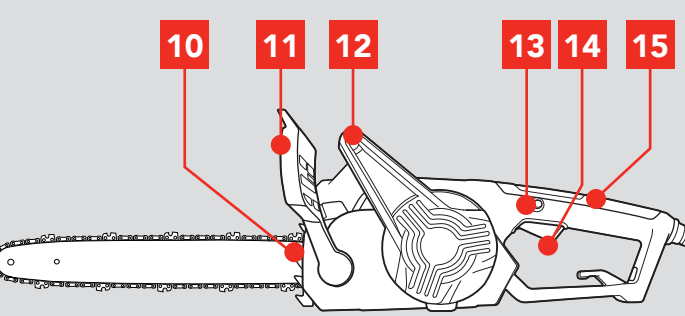
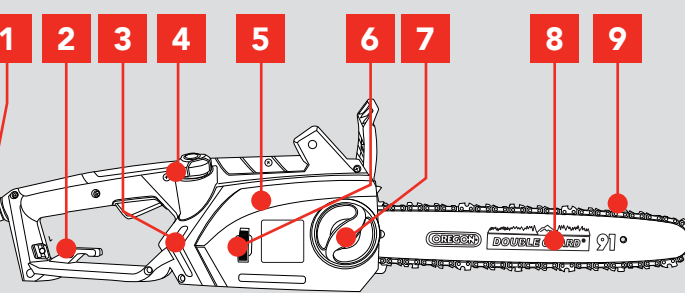

ACCESSORIES

16. Chain bar cover

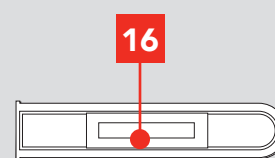

ONLINE MANUAL

Scan this QR Code with your mobile device to take you to the online manual.



ASSEMBLY

1. BEFORE USE

Items Supplied

Please check that the article is complete as specified in the scope of delivery. If parts are missing, please contact our service centre or the sales outlet where you made your purchase at the latest within 5 working days after purchasing the product and upon presentation of a valid bill of purchase. Also, refer to the warranty table in the service information at the end of the operating instructions.

- Open the packaging and take out the equipment with care.
- Remove the packaging material and any packaging and/or transportation braces (if available).
- Check to see if all items are supplied.
- Inspect the equipment and accessories for transport damage.
- If possible, please keep the packaging until the end of the guarantee period.

⚠ DANGER! THE EQUIPMENT AND PACKAGING MATERIAL ARE NOT TOYS. DO NOT LET CHILDREN PLAY WITH PLASTIC BAGS, FOILS OR SMALL PARTS. THERE IS A DANGER OF SWALLOWING OR SUFFOCATION!

Proper Use

The chainsaw is intended for felling trees and for cutting trunks, branches, wooden beams, boards etc. and can be used for cross cuts and longitudinal cuts. It is not suitable for cutting any materials other than wood.

The equipment is to be used only for its prescribed purpose. Any other use is deemed to be a case of misuse. The user / operator and not the manufacturer will be liable for any damage or injuries of any kind caused as a result of this.

Please note that our equipment has not been designed for use in commercial, trade or industrial applications. Our warranty will be voided if the machine is used in commercial, trade or industrial businesses or for equivalent purposes.

Declaration of Conformity

ISC GmbH · Eschenstraße 6 · D-94405 Landau/Isar		EU
explains the following conformity according to EU directives and norms for the following product		
Electric Chainsaw ECS-2040 (Ozito)		
<input type="checkbox"/> 2014/28/EU	<input checked="" type="checkbox"/> 2006/42/EC	TÜV SÜD Product Service GmbH Redentstraße 65 · D-85339 München · Germany Notified Body No.: 0123 Reg. No.: M84-17 10 24192 01395
<input type="checkbox"/> 2005/32/EC, 2009/125/EC	<input checked="" type="checkbox"/> Annex IV	
<input type="checkbox"/> 2014/35/EU		
<input type="checkbox"/> 2006/28/EC		
<input checked="" type="checkbox"/> 2014/30/EU	<input checked="" type="checkbox"/> 2000/14/EC, 2005/88/EC	
<input type="checkbox"/> 2014/32/EU	<input checked="" type="checkbox"/> Annex V	
<input type="checkbox"/> 2014/53/EC	<input type="checkbox"/> Annex VI	
<input type="checkbox"/> 2011/65/EU	Noise measured $L_{WA} = 104.6$ dB (A); guaranteed $L_{WA} = 108$ dB (A) P = 2 kW, L _Q = cm	
<input type="checkbox"/> 2013/86/EC, 2009/142/EC		
<input type="checkbox"/> 89/886/EC, 96/58/EC	<input type="checkbox"/> 2012/46/EU	
<input checked="" type="checkbox"/> 2011/65/EU	Emission No.:	
Standard references: EN 60745-1; EN 60745-2-13; EN 62321; EN 55014-1; EN 55014-2; EN 61000-3-2; EN 61000-3-11		
Landau/Isar, den 11.09.2017		
First CE 17	Art. No.: 30.002.05	1. No.: 11017
Subject to change without notice		
Archive-File/Record: NAPP017164 Documents register: S. Gieshard Wiesenberg 22, D-94405 Landau/Isar		

2. GUIDE BAR & CHAIN

⚠ WARNING! ENSURE THE CHAINSAW IS TURNED OFF & DISCONNECTED FROM THE POWER SUPPLY BEFORE PERFORMING ANY OF THE FOLLOWING OPERATIONS.

Fitting a chain and bar

1. Fully unscrew the side cover lock by turning it in an anti-clockwise direction.
2. Remove the side cover.
3. Fit the chain over the guide bar, making sure that the cutters are facing in the direction of rotation.

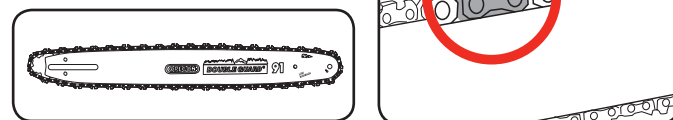
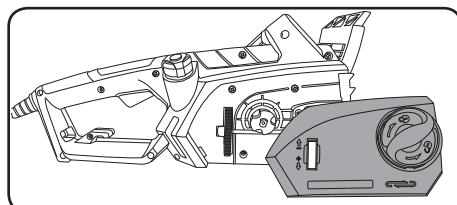
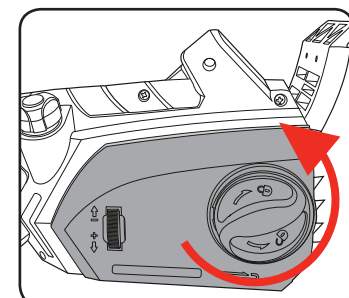

⚠ CAUTION! ALWAYS WEAR GLOVES WHEN HANDLING THE CHAIN AS IT IS VERY SHARP AND CAN CUT YOU WHEN IT IS NOT MOVING.

4. Place the guide bar and chain in position, ensuring that the chain is around sprocket wheel (A). Also ensure that the chain tensioning pin (B) fits into the guide bar. If it does not fit, it can be adjusted slightly with the chain tensioning dial. The chain must not slip off the bar when you do this.

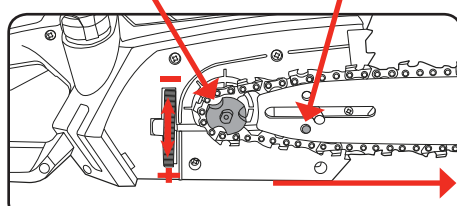
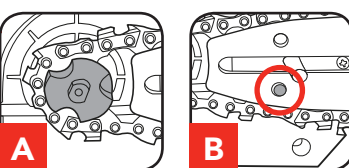

5. Pull the guide bar forward until the chain is closely seated. Make sure that all the drive links are in the groove of the bar.

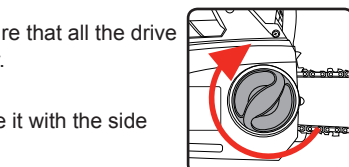

6. Attach the side cover and secure it with the side cover lock.

Note: Do not fully tighten the side cover lock until after adjusting the chain tension.

SETUP & PREPARATION

3. CHAIN TENSION

⚠ WARNING! TO PREVENT ACCIDENTAL STARTING, ENSURE THAT THE CHAINSAW IS DISCONNECTED FROM THE POWER SUPPLY BEFORE MAKING ANY ADJUSTMENTS.

Tensioning the chain

1. Unscrew the side cover lock a few turns to ensure it is loose.
2. Adjust the chain tension with the chain tensioning dial. Rotating the dial downwards increases the tension and rotating the dial up decreases the chain tension.

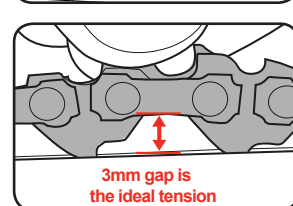
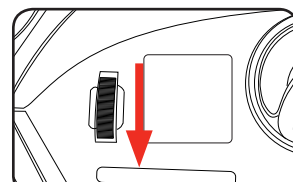
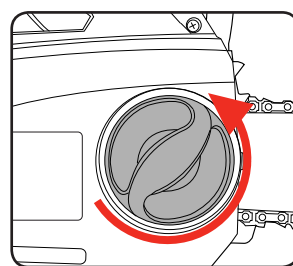

The tension is correct when the chain can be pulled 3mm away from the guide bar when using your finger and thumb. Do not over-tighten as this will reduce the life of the chain and guide bar.



⚠ WARNING! ALL OF THE CHAIN LINKS MUST LIE PROPERLY IN THE GROOVE OF THE GUIDE BAR.

3. Tighten the side cover lock.

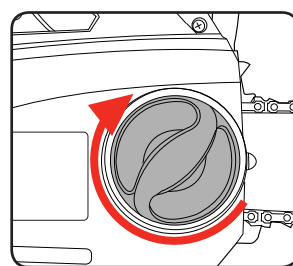

IMPORTANT! THE CHAIN SHOULD BE ADJUSTED BEFORE FIRST USE, AGAIN AFTER 2 - 3 MINUTES OF OPERATION AND RECHECKED AND ADJUSTED IF NECESSARY AFTER EACH 30 MINUTES OF USE. TAKE CARE NOT TO OVER TENSION THE CHAIN.

OPERATION

4. LUBRICATION

NOTE: ONLY USE OIL THAT IS EXPRESSLY LABELLED "CHAIN BAR OIL".

Filling with oil

1. Place the chainsaw on a flat surface and remove the oil tank cap.
2. Fill the tank with chain bar oil, ensuring that no dirt enters the tank. The capacity of the chain oil tank is 160ml.
3. Refit cap and clean any oil spillage.
4. Always fill the oil tank when the oil level falls below the minimum mark on the oil level window.

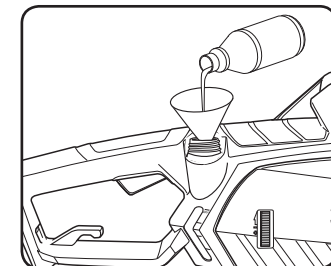

⚠ WARNING! NEVER START WORK UNLESS THE CHAIN AND BAR ARE LUBRICATED.

5. To check the lubricating system, switch on the chainsaw and hold it with the guide bar and chain above some light coloured paper such as newspaper. A steadily increasing stain caused by oil spray shows the lubricating system is working. Chain bar oil may leak if the tool is left for long periods. This is normal. If the tool is to be left unused for an extended time, drain the oil from the tool. Refill before use.

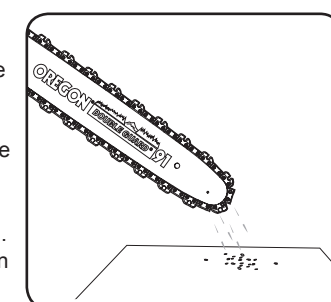

5. CHAIN BRAKE

Chain brake

The chain brake operates automatically in the event of kick back.

The chainsaw is fitted with a hand guard/chain brake which, when operated brings the chain to a stop within a tenth of a second.

The chain brake can be operated manually by pushing it forward or automatically as a result of kickback.

Kick back occurs if the chain catches on the wood being cut and the chainsaw pushes back suddenly.

In the event of kick back, your hand (which is on the front handle during operation) jerks forward causing the back on your hand to push the guard forward, engaging the chain brake and quickly stopping the chain.

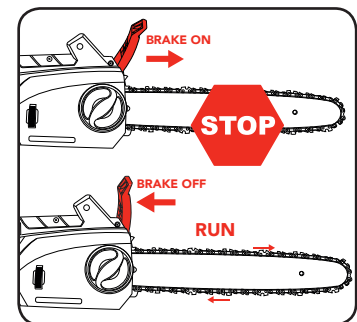

⚠ CAUTION! CHECK THE OPERATION OF THE CHAIN BRAKE ON A REGULAR BASIS. NEVER USE THE SAW IF THE CHAIN BRAKE IS NOT WORKING PROPERLY.

6. SWITCHING ON/OFF

⚠ CAUTION! TO REDUCE THE RISK OF ELECTRIC SHOCK, WE RECOMMEND THE USE OF A RESIDUAL CURRENT DEVICE (RATED AT 30mA OR LESS).

Switching on

1. Pull the hand guard/chain brake towards you. The brake may be stiff and may require to be moved with some force. If the brake is engaged the chain will not operate.

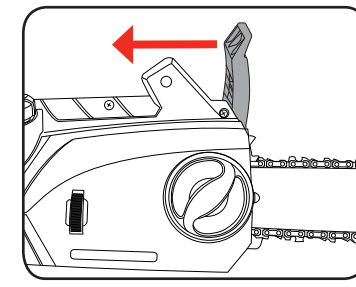

2. Hold the front handle with your left hand and the rear handle with your right hand.

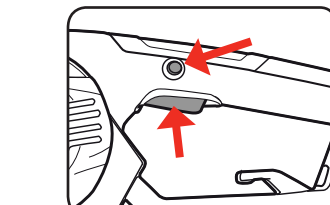
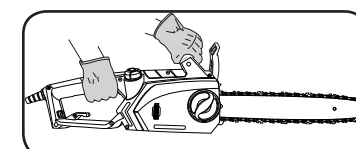

3. Use the thumb of your right hand to push the lock-off switch in and squeeze the on/off trigger to start the motor.

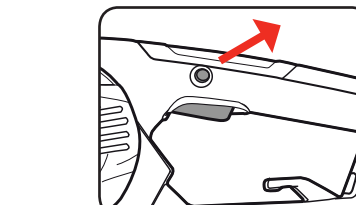

4. The chain will now be running, ready to make a cut. Release the lock-off switch.

Switching off

1. Release the ON/OFF trigger. The integrated brake will bring the running chainsaw to a standstill within a very short space of time.

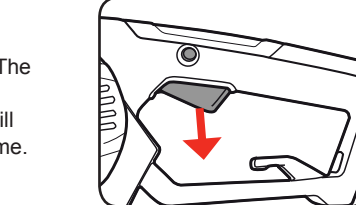

⚠ CAUTION! ALWAYS CARRY THE SAW BY THE FRONT HANDLE. IF THE SAW IS PLUGGED IN AND YOU CARRY IT BY THE REAR HANDLE, THERE IS A RISK THAT YOU COULD ACCIDENTALLY PRESS THE LOCK-OFF SWITCH AND THE ON/OFF TRIGGER AT THE SAME TIME, INADVERTENTLY STARTING THE CHAINSAW.

7. CUTTING

⚠ CAUTION! FIRST TIME USERS SHOULD, AS A MINIMUM PRACTISE, CUT LOGS ON A SAW-HORSE OR CRADLE

⚠ CAUTION! POSITION THE CORD SO THAT IT WILL NOT BE CAUGHT IN BRANCHES DURING CUTTING

1. Press the bucking spikes against the timber ensuring the chain is not making contact with the material being cut.

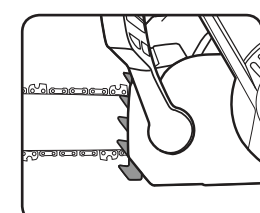

2. Start cutting by holding the chainsaw by the front handle and raising the rear handle.

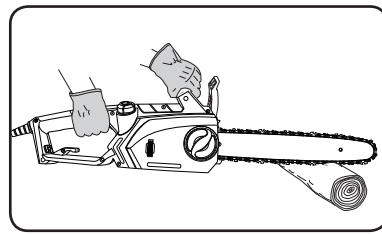

3. If you cannot cut the timber in a single stroke, apply light pressure to the front handle and continue sawing, draw the chainsaw back a little then apply the bucking spikes a little lower and finish the cut by raising the rear handle.

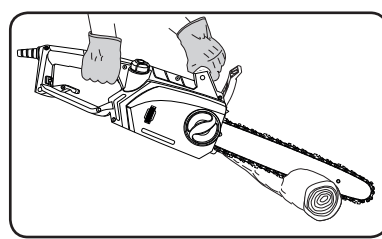

4. Withdraw the chainsaw from the cut while the chain is still running.

