

# GARANTIEURKUNDE

Auf das in der Anleitung bezeichnete Gerät geben wir 2 Jahre Garantie, für den Fall, dass unser Produkt mangelhaft sein sollte. Die 2-Jahres-Frist beginnt mit dem Gefahrenübergang oder der Übernahme des Gerätes durch den Kunden. Voraussetzung für die Geltendmachung der Garantie ist eine ordnungsgemäße Wartung entsprechend der Bedienungsanleitung sowie die bestimmungsgemäße Benutzung unseres Gerätes.

Selbstverständlich bleiben Ihnen die gesetzlichen Gewährleistungsrechte innerhalb dieser 2 Jahre erhalten. Die Garantie gilt für den Bereich der Bundesrepublik Deutschland oder der jeweiligen Länder des regionalen Hauptvertriebspartners als Ergänzung der lokal gültigen gesetzlichen Vorschriften. Bitte beachten Sie Ihren Ansprechpartner des regional zuständigen Kundendienstes oder die unten aufgeführte Serviceadresse.

ISC GmbH · International Service Center  
Eschenstraße 6 · D-944 05 Landau/Isar (Germany)  
Info-Tel. 0180-5 120 509 • Telefax 0180-5 835 830  
Service- und Infoserver: <http://www.isc-gmbh.info>

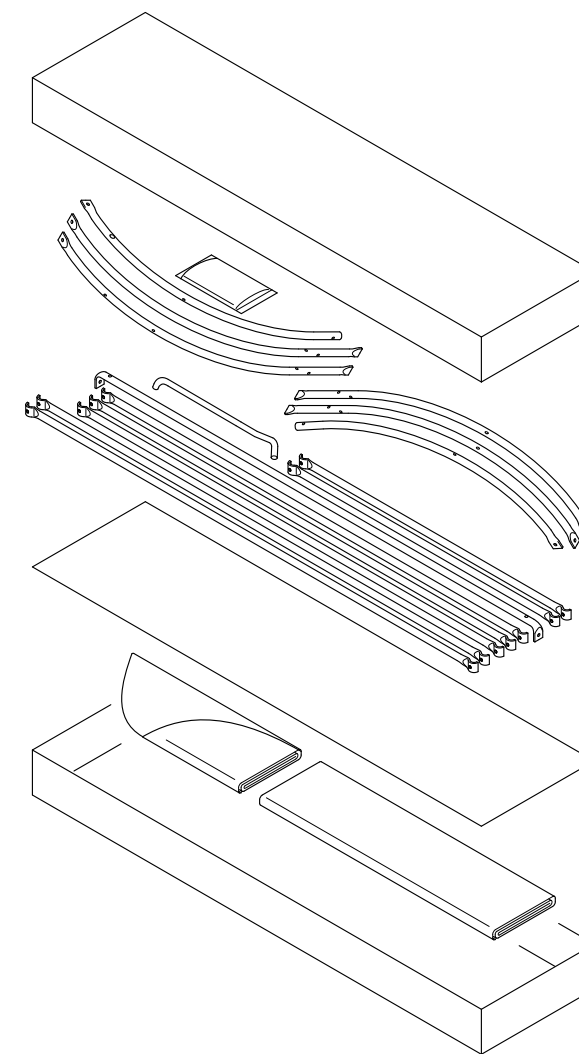







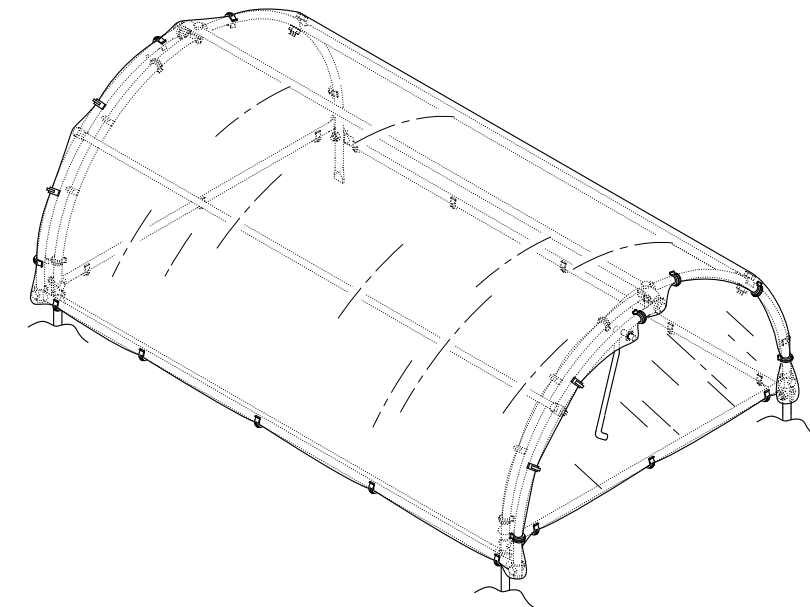

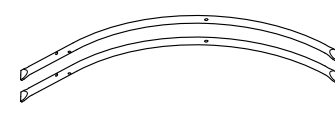

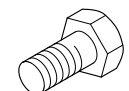

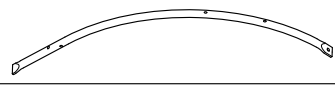

# Einhell®

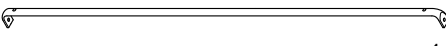
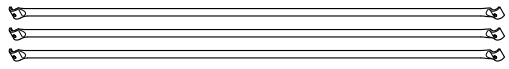
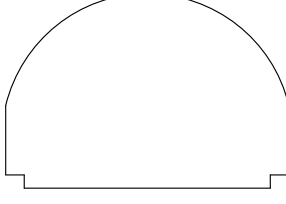
1/4

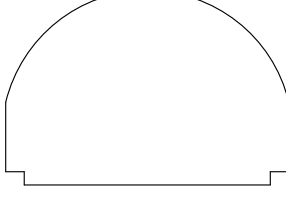
Art.-Nr.: 36.020.20  
I-Nr.: 01015  
FFB 100-150A

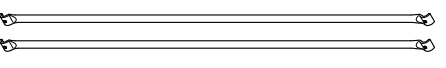
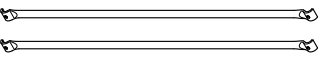

<b>A</b>		1000 mm	<b>K</b>		<b>L</b>		<b>M</b>			
<b>B</b>		1000 mm			1x	M6x30	18x	M6	16x	
<b>C</b>		1000 mm	<b>N</b>				<b>O</b>		<b>P</b>	
<b>D</b>		1450 mm	M6	2x	ø25	6x			40x	
<b>E</b>		1400 mm	<b>Q</b>			<b>R</b>				
<b>F</b>		320 mm								
<b>G</b>		1500 mm								
<b>H</b>		1000 mm								
<b>I</b>		875 mm								
<b>J</b>		875 mm								

- Ⓢ Technische Änderungen vorbehalten
- Ⓢ Technical changes subject to change
- Ⓢ Sous réserve de modifications
- Ⓢ Technische wijzigingen voorbehouden
- Ⓢ Der tages forbehold for tekniske ændringer
- Ⓢ Con riserva di apportare modifiche tecniche
- Ⓢ Zastrzega się wprowadzanie zmian technicznych
- Ⓢ Zadržavamo pravo na tehnične izmjene.

