

ozito

PLUNGE SAW KIT

1200W

INSTRUCTION MANUAL

SPECIFICATIONS

Motor:	1200W
Input:	230-240V ~ 50Hz
No Load Speed:	5,200/min
Blade Diameter:	165mm (6½")
Blade Bore:	20mm
Depth of Cut:	55mm @ 90° 42mm @ 45°
Guide Rail Length:	700mm
Weight:	4.65kg

ozito.com.au

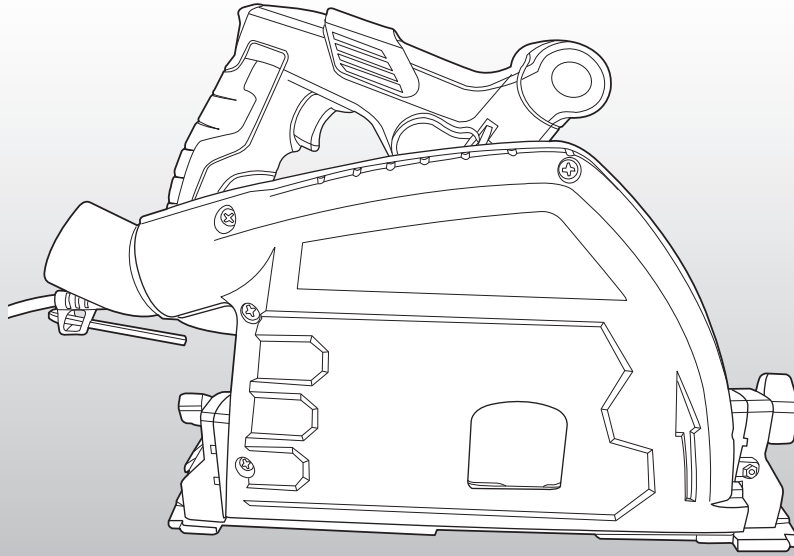

WHAT'S IN THE BOX

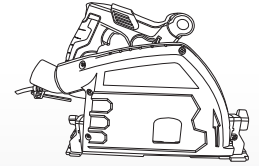

Plunge Saw

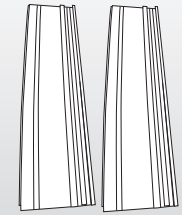

Guide Rails x 2

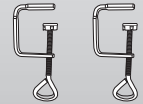

Clamps x 2



Hex Keys (3 & 5mm) & Joiner

3 YEAR REPLACEMENT WARRANTY

PLS-1214

WARRANTY

IN ORDER TO MAKE A CLAIM UNDER THIS WARRANTY YOU MUST RETURN THE PRODUCT TO YOUR NEAREST BUNNINGS WAREHOUSE WITH YOUR BUNNINGS REGISTER RECEIPT. PRIOR TO RETURNING YOUR PRODUCT FOR WARRANTY PLEASE TELEPHONE OUR CUSTOMER SERVICE HELPLINE:

Australia 1800 069 486

New Zealand 0508 069 486

TO ENSURE A SPEEDY RESPONSE PLEASE HAVE THE MODEL NUMBER AND DATE OF PURCHASE AVAILABLE. A CUSTOMER SERVICE REPRESENTATIVE WILL TAKE YOUR CALL AND ANSWER ANY QUESTIONS YOU MAY HAVE RELATING TO THE WARRANTY POLICY OR PROCEDURE.

The benefits provided under this warranty are in addition to other rights and remedies which are available to you at law.

Our goods come with guarantees that cannot be excluded at law. You are entitled to a replacement or refund for a major failure and for compensation for any other reasonably foreseeable loss or damage. You are also entitled to have the goods repaired or replaced if the goods fail to be of acceptable quality and the failure does not amount to a major failure.

Generally you will be responsible for all costs associated with a claim under this warranty, however, where you have suffered any additional direct loss as a result of a defective product you may be able to claim such expenses by contacting our customer service helpline above.

3 YEAR REPLACEMENT WARRANTY

Your product is guaranteed for a period of **36 months from the original date of purchase**. If a product is defective it will be replaced in accordance with the terms of this warranty. Warranty excludes consumable parts, for example: O-rings, bearing, seals gaskets.

WARNING

The following actions will result in the warranty being void.

- If the tool has been operated on a supply voltage other than that specified on the tool.
- If the tool shows signs of damage or defects caused by or resulting from abuse, accidents or alterations.
- Failure to perform maintenance as set out within the instruction manual.
- If the tool is disassembled or tampered with in any way.
- Professional, industrial or high frequency use.

KNOW YOUR PRODUCT

PLUNGE SAW

- | | |
|-----------------------|-----------------------------|
| 1. Hex Key Holder | 6. Front Handle |
| 2. Dust Port | 7. Rear Bevel Locking Knob |
| 3. Safety Switch | 8. Saw Blade |
| 4. On/Off Trigger | 9. Front Bevel Locking Knob |
| 5. Blade Change Lever | 10. Cutting Line Guide |

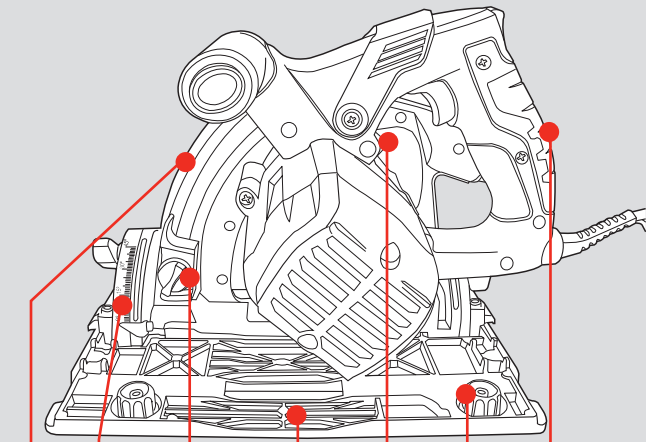
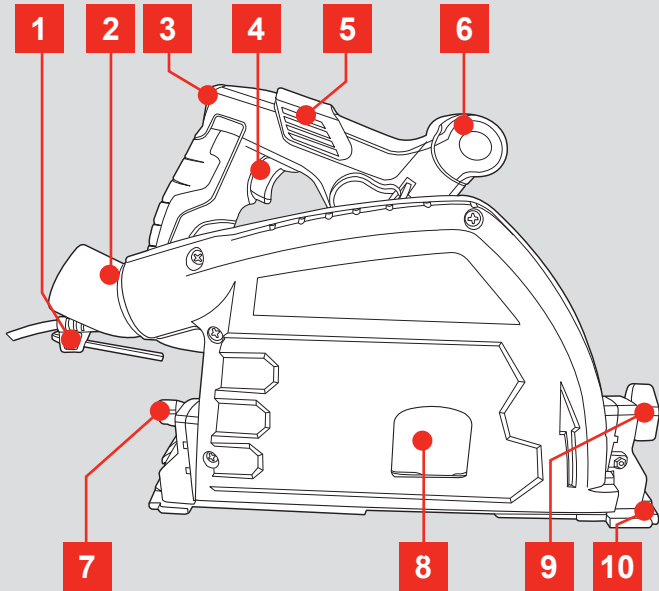

- | | |
|-------------------------|-------------------------------|
| 11. Cutting Depth Scale | 15. Blade Locking Lever |
| 12. Bevel Angle Scale | 16. Guide Rail Adjusting Knob |
| 13. Cutting Depth Knob | 17. Rear Handle |
| 14. Base Plate | |

ONLINE MANUAL

Scan this QR Code with your mobile device to take you to the online manual.



SETUP & PREPARATION

1. DEPTH & BEVEL ADJUSTMENT



WARNING! ENSURE THE TOOL IS SWITCHED OFF AND DISCONNECTED FROM THE POWER SUPPLY BEFORE PERFORMING ANY OF THE FOLLOWING TASKS.

Cutting Depth Adjustment

Depth should be adjusted so that no more than one tooth is protruding through the timber. This helps to minimise splintering.

1. Loosen the Cutting Depth Knob.

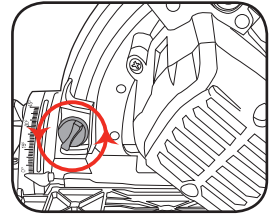

2. Press the Knob inwards and slide to set the desired depth using the Cutting Depth Scale.

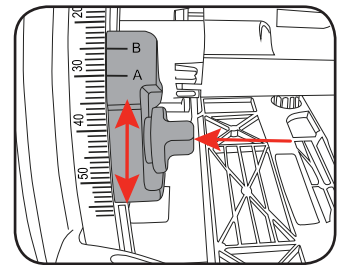
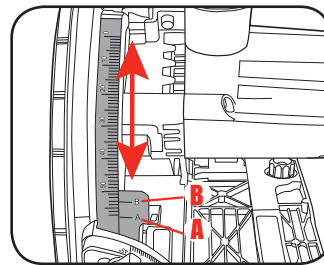

- Cutting depth **A** shows the cutting depth **WITHOUT** Guide rail fitted.
- Cutting depth **B** shows the cutting depth **WITH** guide rail fitted.

3. Tighten Cutting Depth Knob.

Bevel Adjustment

1. Loosen both Bevel Locking Knobs.
2. Align Base Plate to desired angle on Bevel Angle Scale.

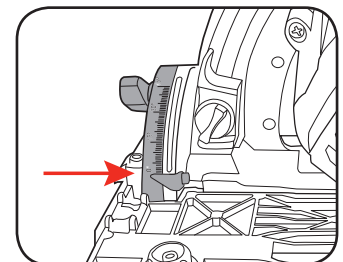
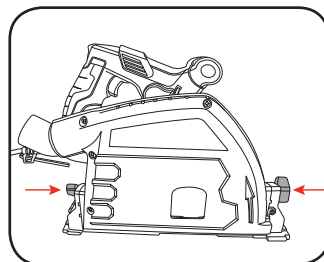

3. Tighten Bevel Locking Knobs.

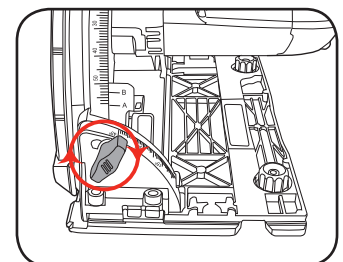

3 YEAR REPLACEMENT WARRANTY

OPERATION

2. CONTROLS



WARNING! THE TOOL IS RECOMMENDED FOR USE WITH A RESIDUAL CURRENT DEVICE WITH A RATED RESIDUAL CURRENT OF 30mA OR LESS.

Turning On and Off

1. Slide and hold the Safety Switch then squeeze the On/Off Trigger to start the saw.

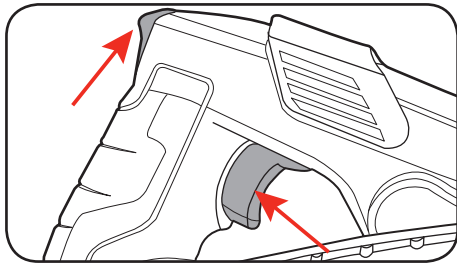

Note: Allow the saw to reach full speed before beginning a cut.

2. To stop the saw, release the On/Off Trigger.

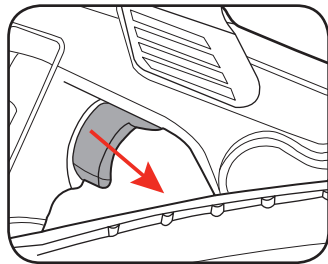

WARNING! AFTER USE, HOLD THE SAW AWAY FROM YOUR BODY UNTIL THE BLADE STOPS COMPLETELY.

Guide Rail Adjustment

Tighten or loosen the Adjusting knobs to minimise or increase the clearance between the plunge saw and the guide rail.

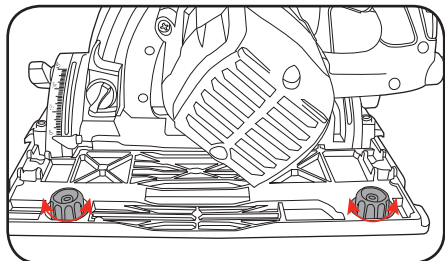

3. CUTTING GUIDES

Cutting Line Guide

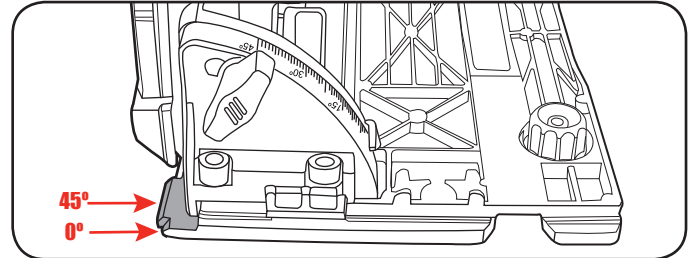

The cutting guide will give an approximate line of cut. For a straight cut, use the 0° notch. For a 45° cut, use the 45° notch.

Using the Guide Rail

1. To connect two rails, slide the Joiner into the notch on the underside of one Guide Rail then tighten the screws with the small (3mm) Hex Key provided.

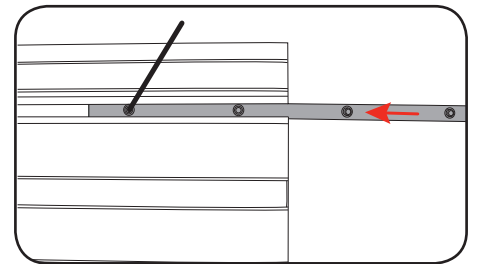

2. Slide on the second Guide Rail fully into position and tighten in place.

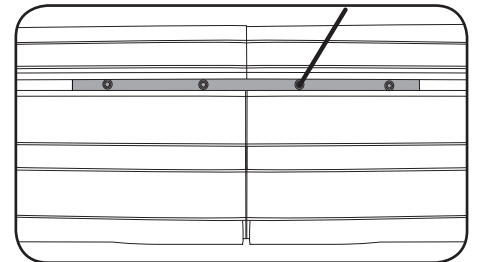

Note: Additional Guide Rails may be assembled if required by following the above steps.

3. Place the Plunge Saw in the Guide Rail.

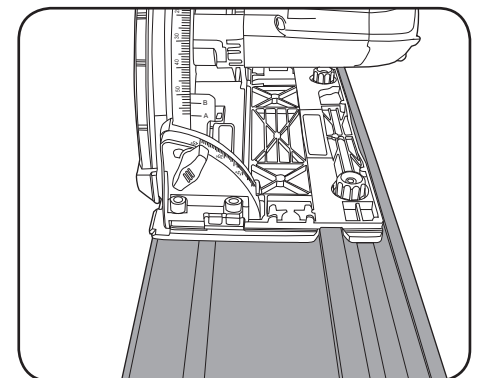

Note: In confined spaces using one 700mm guide rail is ideal.

4. SAWING WITH THE GUIDE RAIL

The Guide Rail is used to carry out straight cuts.

The rubber lip (black rubber lip) on the guide rail acts as a splinter guard; it prevents fraying of the surface while sawing wooden materials. For this, the teeth of the saw blade must face directly against the rubber lip.

Note: On the very first cut, the rubber lip will be adapted with the guide rail to the plunge saw.

1. Place the Guide Rail onto the material to be cut.
2. Place a Clamp at either end of the Guide Rail and clamp the material to be cut.

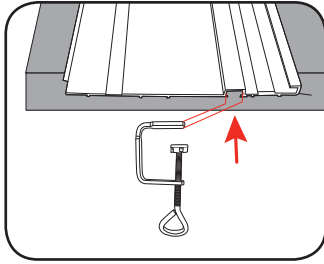
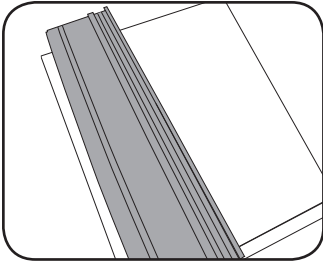

3. Ensure the cutting depth is set and locked to the desired depth.
4. Place the Plunge Saw in the guide Rail.

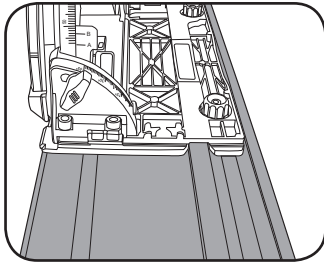
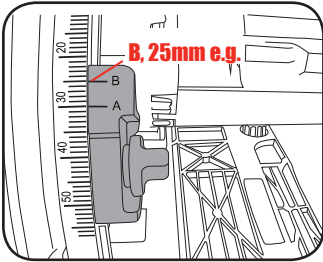

5. Hold the saw securely with both hands and start the tool.
6. Press the saw downwards to reach the sawing depth set at step 3.

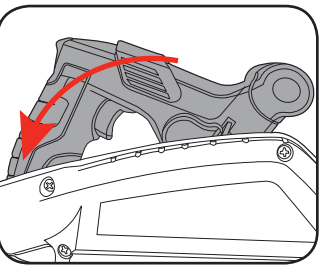
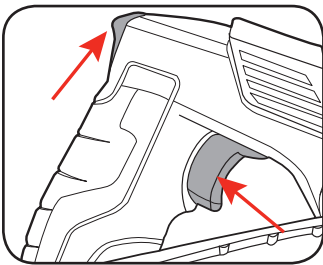

7. Move the saw through the material to perform the cut.

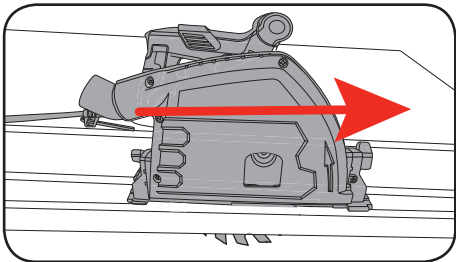

8. Once complete, release the on/off trigger and move the saw blade upwards.

5. BLADE FITMENT



WARNING! ENSURE THE TOOL IS SWITCHED OFF AND DISCONNECTED FROM THE POWER SUPPLY BEFORE PERFORMING ANY OF THE FOLLOWING TASKS.

The tool is recommended for wood cutting only and is not recommended for use with abrasive wheels or masonry/diamond cutting wheels. Only use 165mm wood cutting blades.

1. Lift the Blade Change Lever.

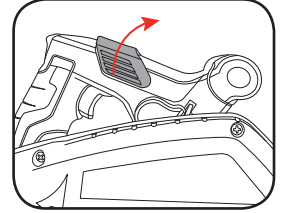

2. Press and hold the Safety Switch and push the saw downwards until the Blade Bolt is visible. The motor will lock into place.

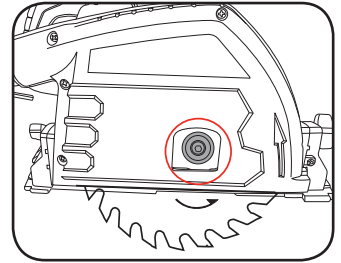

3. Press and hold the Blade Locking Lever.

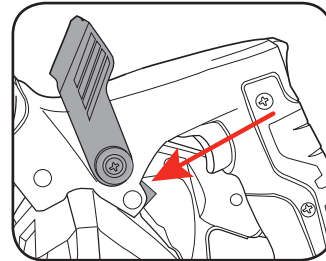

4. Use the large (5mm) Hex Key to undo the Blade Bolt, turning anti-clockwise.

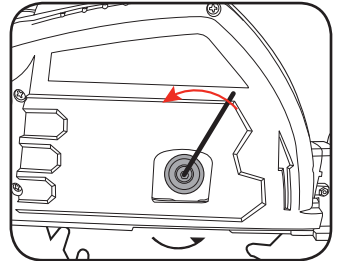

IMPORTANT! ALWAYS WEAR GLOVES WHEN HANDLING SAW BLADES, RISK OF INJURY.

5. Remove and replace blade. Ensure arrows on the blade point in the same direction as the arrow on the blade guard.

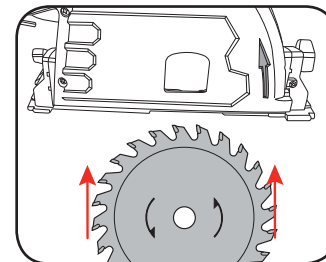

6. Fit outer Blade Flange and Blade Bolt. Depress Blade Locking Lever and tighten blade bolt.

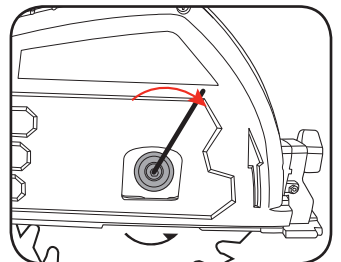

7. Set the plunge saw to its original position.

TROUBLESHOOTING

Circular Saw Tips

Always hold the soft grip handle with one hand and the front handle with the other. Maintain a firm grip and operate the on/off switch with a positive action.

Never force the saw. Use light and continuous pressure.

Allow the saw to reach full speed before beginning a cut.

When cutting is interrupted, to resume cutting, depress the lock-off button and squeeze the on/off switch and allow the blade to reach full speed, re-enter the cut slowly and resume cutting.

When cutting across the grain, the fibres of the wood have a tendency to tear and lift. Advancing the saw slowly minimizes this effect. For a finished cut, a cross cut blade or mitre blade is recommended.

Sparking visible through the housing air vents

A small amount of sparking may be visible through the housing vents. This is normal and does not indicate a problem.

Excessive sparking visible through the housing air vents and/or the saw failing to operate

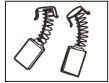

May indicate the carbon brushes have worn out and need to be replaced. Carbon brushes should only be replaced by a qualified electrician or power tool repairer.

MAINTENANCE

- Keep the vents of the saw clean at all times. If possible, prevent foreign matter from entering the vents.
- After each use, blow air through the saw housing and guard, to ensure it is free from all dust particles which may build up. Build up of dust particles may cause the saw to overheat and fail.
- If the enclosure of the saw requires cleaning, do not use solvents but a moist soft cloth only. Never let any liquid get inside the saw; never immerse any part of the saw into a liquid.
- The grease in the gearbox will require replenishment after extensive use of the saw. Please see a power tool repairer to provide this service.

Carbon Brushes

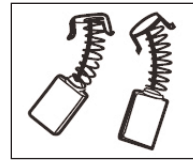

When the carbon brushes wear out, the saw will spark and/or stop. Discontinue use as soon as this happens. They should be replaced prior to recommencing use of the saw. Carbon brushes are a wearing component of the saw therefore not covered under warranty. Continuing to use the saw when carbon brushes need to be replaced may cause permanent damage to the saw. Carbon brushes will wear out after many uses. When the carbon brushes need to be replaced, take the saw to an electrician or a power tool repairer for a quick and low cost replacement. Always replace both carbon brushes at the same time.

Note: Ozito Industries will not be responsible for any damage or injuries caused by the repair of the saw by an unauthorised person or by mishandling of the saw.

DESCRIPTION OF SYMBOLS

V	Volts	Hz	Hertz
~	Alternating current	W	Watts
/min	Revolutions or reciprocation per minute	No	No load speed
	Regulator compliance mark		Read instruction manual
	Warning		Wear hearing protection
	Wear a breathing mask		Wear eye protection
	Important. Risk of injury! Do not reach into the running saw blade		

SPARE PARTS

BLADES: You will find a selection of blades available from the Tool Shop at Bunnings Warehouse.

Spare parts can be ordered from the Special Orders Desk at your local Bunnings Warehouse.

For further information, or any parts not listed here, visit www.ozito.com.au or contact Ozito Customer Service:

Australia 1800 069 486

New Zealand 0508 069 486

E-mail: enquires@ozito.com.au

CARING FOR THE ENVIRONMENT



Power tools that are no longer usable should not be disposed of with household waste but in an environmentally friendly way. Please recycle where facilities exist. Check with your local council authority for recycling advice.



Recycling packaging reduces the need for landfill and raw materials. Reuse of recycled material decreases pollution in the environment. Please recycle packaging where facilities exist. Check with your local council authority for recycling advice.

ELECTRICAL SAFETY



WARNING! When using mains-powered tools, basic safety precautions, including the following, should always be followed to reduce risk of fire, electric shock, personal injury and material damage.

Read the whole manual carefully and make sure you know how to switch the tool off in an emergency, before operating the tool.

Save these instructions and other documents supplied with this tool for future reference.

The electric motor has been designed for 230V and 240V only. Always check that the power supply corresponds to the voltage on the rating plate.

Note: The supply of 230V and 240V on Ozito tools are interchangeable for Australia and New Zealand.



This tool is double insulated; therefore no earth wire is required.

If the supply cord is damaged, it must be replaced by an electrician or a power tool repairer in order to avoid a hazard.

Note: Double insulation does not take the place of normal safety precautions when operating this tool. The insulation system is for added protection against injury resulting from a possible electrical insulation failure within the tool.

Using an Extension Lead

Always use an approved extension lead suitable for the power input of this tool. Before use, inspect the extension lead for signs of damage, wear and ageing. Replace the extension lead if damaged or defective.

When using an extension lead on a reel, always unwind the lead completely. Use of an extension lead not suitable for the power input of the tool or which is damaged or defective may result in a risk of fire and electric shock.

GENERAL POWER TOOL SAFETY WARNINGS



WARNING! Read all safety warnings and all instructions. Failure to follow the warnings and instructions may result in electric shock, fire and/or serious injury.

Save all warnings and instructions for future reference. The term “power tool” in the warnings refers to your mains-operated (corded) power tool or battery-operated (cordless) power tool.

1. Work area safety

- Keep work area clean and well lit.** Cluttered or dark areas invite accidents.
 - Do not operate power tools in explosive atmospheres, such as in the presence of flammable liquids, gases or dust.** Power tools create sparks which may ignite the dust or fumes.
 - Keep children and bystanders away while operating a power tool.** Distractions can cause you to lose control.
- ## 2. Electrical safety
- Power tool plugs must match the outlet. Never modify the plug in any way.** Do not use any adapter plugs with earthed (grounded) power tools. Unmodified plugs and matching outlets will reduce risk of electric shock.
 - Avoid body contact with earthed or grounded surfaces, such as pipes, radiators, ranges and refrigerators.** There is an increased risk of electric shock if your body is earthed or grounded.
 - Do not expose power tools to rain or wet conditions.** Water entering a power tool will increase the risk of electric shock.
 - Do not abuse the cord. Never use the cord for carrying, pulling or unplugging the power tool.** Keep cord away from heat, oil, sharp edges or moving parts. Damaged or entangled cords increase the risk of electric shock.
 - When operating a power tool outdoors, use an extension cord suitable for outdoor use.** Use of a cord suitable for outdoor use reduces the risk of electric shock.
 - If operating a power tool in a damp location is unavoidable, use a residual current device (RCD) protected supply.** Use of an RCD reduces the risk of electric shock.

3. Personal safety

- Stay alert, watch what you are doing and use common sense when operating a power tool. Do not use a power tool while you are tired or under the influence of drugs, alcohol or medication.** A moment of inattention while operating power tools may result in serious personal injury.
- Use personal protective equipment. Always wear eye protection.** Protective equipment such as dust mask, non-skid safety shoes, hard hat, or hearing protection used for appropriate conditions will reduce personal injuries.
- Prevent unintentional starting. Ensure the switch is in the off-position before connecting to power source and/or battery pack, picking up or carrying the tool.** Carrying power tools with your finger on the switch or energising power tools that have the switch on invites accidents.

- Remove any adjusting key or wrench before turning the power tool on.** A wrench or a key left attached to a rotating part of the power tool may result in personal injury.
 - Do not overreach. Keep proper footing and balance at all times.** This enables better control of the power tool in unexpected situations.
 - Dress properly. Do not wear loose clothing or jewellery. Keep your hair, clothing and gloves away from moving parts.** Loose clothes, jewellery or long hair can be caught in moving parts.
 - If devices are provided for the connection of dust extraction and collection facilities, ensure these are connected and properly used.** Use of dust collection can reduce dust-related hazards.
- ## 4. Power tool use and care
- Do not force the power tool. Use the correct power tool for your application.** The correct power tool will do the job better and safer at the rate for which it was designed.
 - Do not use the power tool if the switch does not turn it on and off.** Any power tool that cannot be controlled with the switch is dangerous and must be repaired.
 - Disconnect the plug from the power source and/or the battery pack from the power tool before making any adjustments, changing accessories, or storing power tools.** Such preventive safety measures reduce the risk of starting the power tool accidentally.
 - Store idle power tools out of the reach of children and do not allow persons unfamiliar with the power tool or these instructions to operate the power tool.** Power tools are dangerous in the hands of untrained users.
 - Maintain power tools. Check for misalignment or binding of moving parts, breakage of parts and any other condition that may affect the power tool's operation. If damaged, have the power tool repaired before use.** Many accidents are caused by poorly maintained power tools.
 - Keep cutting tools sharp and clean.** Properly maintained cutting tools with sharp cutting edges are less likely to bind and are easier to control.
 - Use the power tool, accessories and tool bits etc. in accordance with these instructions, taking into account the working conditions and the work to be performed.** Use of the power tool for operations different from those intended could result in a hazardous situation.
- ## 5. Service
- Have your power tool serviced by a qualified repair person using only identical replacement parts.** This will ensure that the safety of the power tool is maintained.

PLUNGE SAW SAFETY WARNINGS



WARNING!

a) Keep hands away from cutting area and the blade. Keep your second hand on auxiliary handle, or motor housing. If both hands are holding the saw, they cannot be cut by the blade.

b) Do not reach underneath the workpiece. The guard cannot protect you from the blade below the workpiece.

c) Adjust the cutting depth to the thickness of the workpiece. Less than a full tooth of the blade teeth should be visible below the workpiece.

d) Never hold piece being cut in your hands or across your leg. Secure the workpiece to a stable platform. It is important to support the work properly to minimize body exposure, blade binding, or loss of control.

e) Hold power tool by insulated gripping surfaces when performing an operation where the cutting tool may contact hidden wiring or its own cord. Contact with a “live” wire will also make exposed metal parts of the power tool “live” and shock the operator.

f) When ripping always use a rip fence or straight edge guide. This improves the accuracy of cut and reduces the chance of blade binding.

g) Always use blades with correct size and shape (diamond versus round) of arbour holes. Blades that do not match the mounting hardware of the saw will run eccentrically, causing loss of control.

h) Never use damaged or incorrect blade washers or bolt. The blade washers and bolt were specially designed for your saw, for optimum performance and safety of operation.

Further safety instructions for all saws

Causes and operator prevention of kickback:

- Kickback is a sudden reaction to a pinched, bound or misaligned saw blade, causing an uncontrolled saw to lift up and out of the workpiece toward the operator;
- When the blade is pinched or bound tightly by the kerf closing down, the blade stalls and the motor reaction drives the unit rapidly back toward the operator;
- If the blade becomes twisted or misaligned in the cut, the teeth at the back edge of the blade can dig into the top surface of the wood causing the blade to climb out of the kerf and jump back toward the operator.

Kickback is the result of saw misuse and/or incorrect operating procedures or conditions and can be avoided by taking proper precautions as given below.

a) Maintain a firm grip with both hands on the saw and position your arms to resist kickback forces. Position your body to either side of the blade, but not in line with the blade. Kickback could cause the saw to jump backwards, but kickback forces can be controlled by the operator, if proper precautions are taken.

b) When blade is binding, or when interrupting a cut for any reason, release the trigger and hold the saw motionless in the material until the blade comes to a complete stop. Never attempt to remove the saw from the work or pull the saw backward while the blade is in motion or kickback may occur. Investigate and take corrective actions to eliminate the cause of blade binding.

c) When restarting a saw in the workpiece, centre the saw blade in the kerf and check that saw teeth are not engaged into the material. If saw blade is binding, it may walk up or kickback from the workpiece as the saw is restarted.

d) Support large panels to minimise the risk of blade pinching and kickback. Large panels tend to sag under their own weight. Supports must be placed under the panel on both sides, near the line of cut and near the edge of the panel.

e) Do not use dull or damaged blades. Blunt or improperly set blades produce narrow kerf causing excessive friction, blade binding and kickback.

f) Blade depth and bevel adjusting locking levers must be tight and secure before making cut. If blade adjustment shifts while cutting, it may cause binding and kickback.

g) Use extra caution when making a “plunge cut” into existing walls or other blind areas. The protruding blade may cut objects that can cause kickback.

h) Check guard for proper closing before each use. Do not operate the saw if guard does not move freely and close instantly. Never clamp or tie the guard so that the blade is exposed. If saw is accidentally dropped, guard may be bent. Check to make sure that guard moves freely and does not touch the blade or any other part, in all angles and depths of cut.

i) Check the operation and condition of the guard return spring. If the guard and the spring are not operating properly, they must be serviced before use. Guard may operate sluggishly due to damaged parts, gummy deposits, or a build-up of debris.

j) Assume that the base plate of the saw will not shift while performing the “plunge cut” when the blade bevel setting is not at 90 degree. Blade shifting sideways will cause binding and likely kickback.

k) Always observe that the guard is covering the blade before placing saw down on bench or floor. An unprotected, coasting blade will cause the saw to walk backwards, cutting whatever is in its path. Be aware of the time it takes for the blade to stop after switch is released.

This appliance is not intended for use by persons (including children) with reduced physical, sensory or mental capabilities, or lack of experience and knowledge, unless they have been given supervision or instruction concerning use of the appliance by a person responsible for their safety.

Recommendations for the use of a residual current device with a rated residual current of 30mA or less.

Never hold piece being cut in your hands or across your leg. Secure the workpiece to a stable platform. It is important to support the work properly to minimize body exposure, blade binding, or loss of control.

Do not use the tool with abrasive or masonry/wet diamond wheels.

Only use blade diameter(s) in accordance with the markings on the tool.