

Quick start guide

25cc Petrol Grass Trimmer



! Read the safety instructions in the user guide before you start.

1. Pack contents/parts

NOTICE!

This quick start guide is intended for experienced users who have already assembled the tool, please refer to the main Instruction Manual for further details.

NOTICE!

Diagram numbers refer to those in the main Instruction Manual. Please refer to the main Instruction Manual if you are unsure.

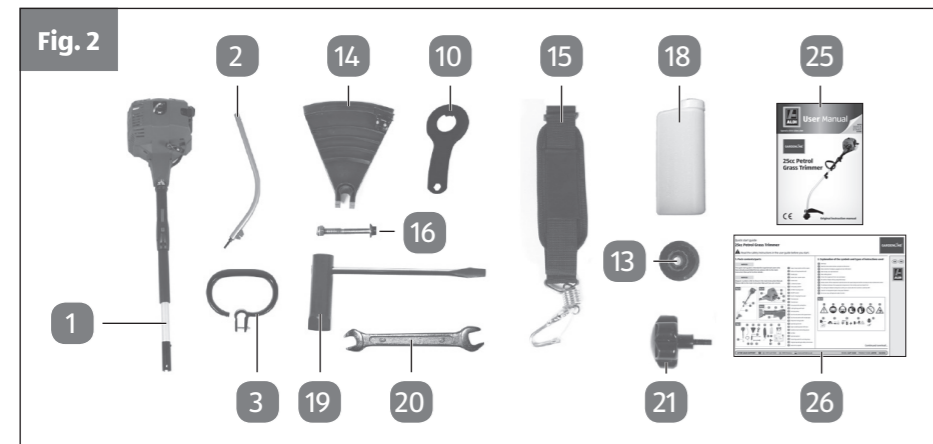
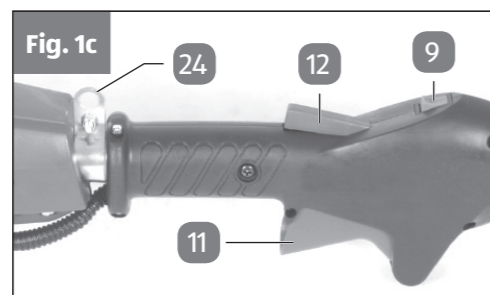
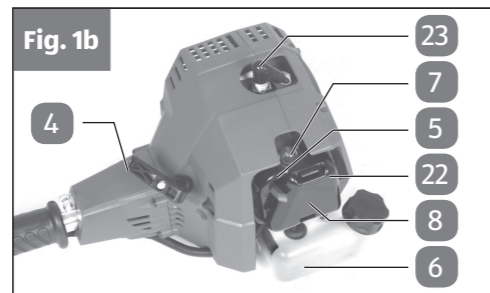
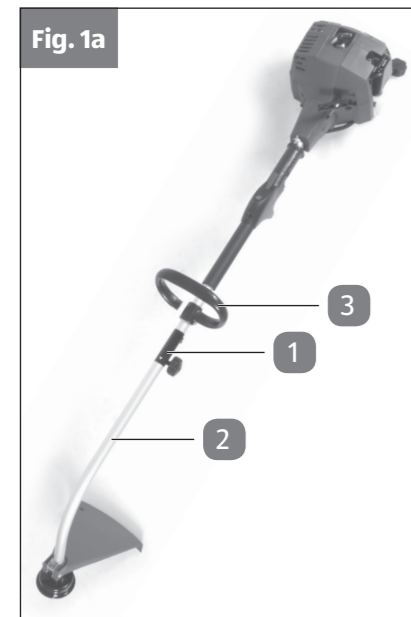

- 1 Upper long handle shaft & engine
- 2 Bottom of long handle shaft
- 3 Steady grip
- 4 Starter line / starter cable
- 5 Choke lever
- 6 2-Stroke fuel tank
- 7 Fuel pump 'primer'
- 8 Air filter housing cover
- 9 ON/OFF switch
- 10 Key for changing the spool
- 11 Throttle lever
- 12 Throttle lock
- 13 Line spool with cutting line
- 14 Cutting line guard hood
- 15 Carrying strap
- 16 Set of screw and nut for guard hood
- 17 Set of screw and nut for steady grip
- 18 Oil/petrol mixing bottle
- 19 Spark plug wrench
- 20 Open-ended spanner 8/10 mm
- 21 Handle screw (Connecting piece)
- 22 Air filter
- 23 Spark plug boot
- 24 Fastening eyelet for carrying strap
- 25 Original operating & safety instructions
- 26 Quick set-up guide

2. Explanation of the symbols and types of instructions used

- 1 Warning!
- 2 Read the instructions before using for the first time!
- 3 Wear protective headgear, goggles and ear Defenders!
- 4 Wear sturdy, non-slip footwear!
- 5 Wear safety gloves!
- 6 Protect the equipment from rain and damp!
- 7 Be careful of objects being catapulted away!
- 8 Always switch off the equipment and disconnect the spark plug boot before carrying out any maintenance work!
- 9 The distance between the equipment and persons in the vicinity must be at least 15 m!
- 10 The cutting tool (blade/cutting line) continues to rotate after the machine is switched off!
- 11 Caution: Hot equipment parts. Keep your distance!
- 12 Do not use any cutting tools made of metal.

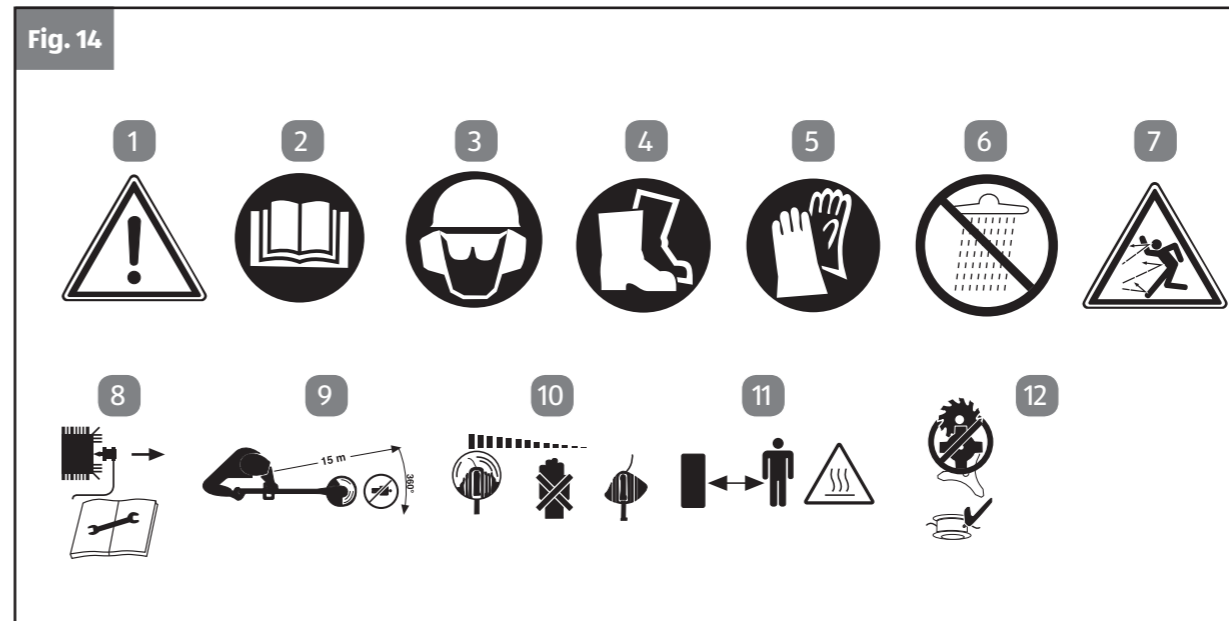

Continued overleaf...

GB IRE



3. Preparing and Assembling the Petrol Grass Trimmer

Fit the steady grip (Fig. 3a-3c) without fully tightening the screw. Re-adjust and fully tighten the screw, only when the carry strap (Fig.2/Item 15) has been fitted.

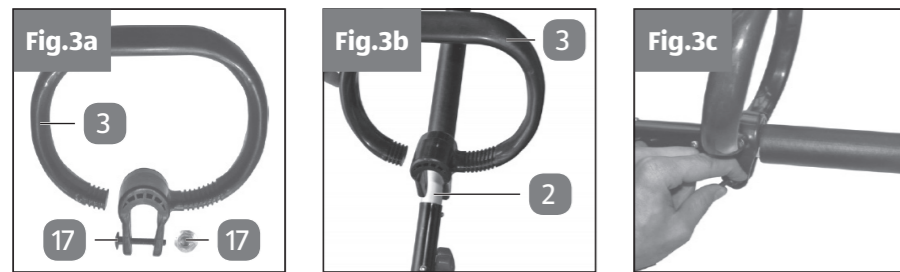

Connect the bottom shaft (2) to Upper shaft & engine (1) (See Figures 4a-4b) making sure the square drive shaft on lower shaft (2) is inserted into square drive on upper shaft (1) correctly and ensure the spring loaded locking clip is aligned with the hole provided and in place and the securing knob (Fig.2/Items 21) is fitted and tightened. If the drive is not correctly inserted then the shaft & spool will not turn.

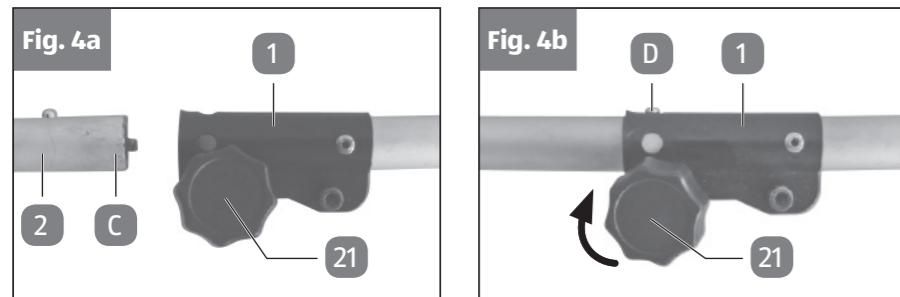

Attach the guard hood (14) to the lower long handle (Fig. 5a). Screw the guard hood tightly in position with the screw set (16) (Fig. 5b).

Fit the spool assembly (13) to the bottom of the drive shaft, aligning the hexagonal hole in the spool to the shaft (Fig. 5c), and then add the retaining screw (Fig. 6a/Item G) and tighten clockwise. Use the key (10) to fully tighten the retaining screw (Fig. 5d).

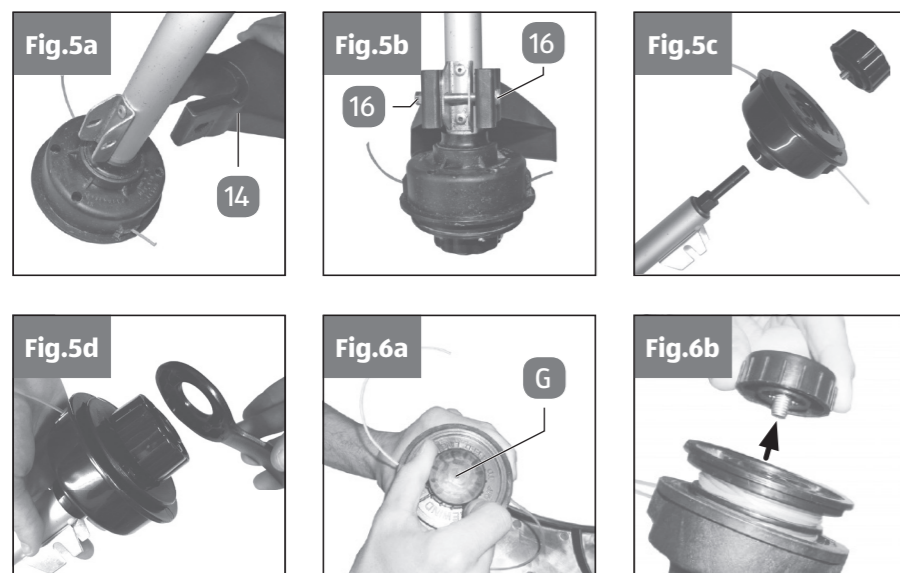

Fit the carry strap to the unit with the clip to the hook on the upper shaft (Fig 8b/Item 24), and adjust the steady grip/ carry strap to suit the working height. Ensure the steady grip screw (Fig 1/Item 3) is fully tightened before use.

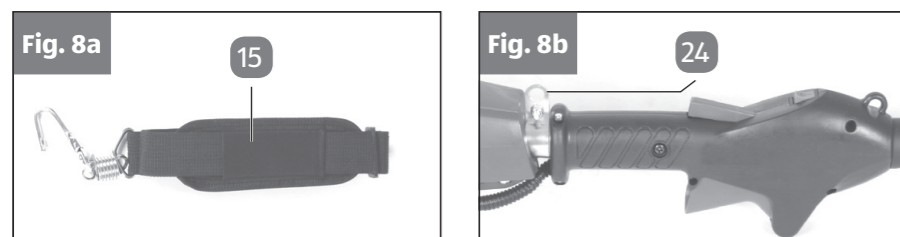

⚠ WARNING!

Always use the strap when working with the equipment. Attach the strap as soon as you have started the engine and it is running in idle mode. Switch off the engine before you take off the carrying strap.

Slip the shoulder strap (Fig. 8a) from the RHS, over the left shoulder. Set the length of the shoulder strap in such a way that the cutting head runs parallel to the ground. Establish the optimum length of the shoulder strap, by making a few swinging movements without starting the engine (Fig. 9a).

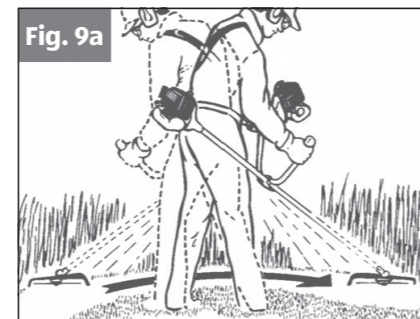

4. Fuel and oil – Recommended fuels

Use only a mixture of unleaded petrol and special 2-stroke engine oil. Mix the fuel mixture as indicated in the fuel mixing table.

⚠ CAUTION!

Do not use a fuel mixture which has been stored for longer than 90 days.

⚠ CAUTION!

Never use 2-stroke oil with a recommended mixing ratio of 100:1. The manufacturer's warranty will be voided in case of engine damage due to inadequate lubrication.

⚠ CAUTION!

Only use containers designed and approved for the purpose to transport and store fuel. Pour the correct quantities of petrol and 2-stroke oil into the mixing bottle provided (see scale printed on the bottle). Then shake the bottle well.

6. Fuel mixing table

Mixing Procedure: 40 parts petrol to 1 part oil.

Petrol	2-stroke oil
1 litre	25 ml
5 litres	125 ml

5. Starting the 25cc Petrol Grass Trimmer

1. Set the machine down on a hard, level surface (See also Fig. 1b - Fig. 1c).
2. Press the fuel pump (primer) (Fig. 1b/Item 7) 10 times.
3. Move the On/Off switch (Fig. 1c/Item 9) to '1'.
4. Set the choke lever (Fig. 1b/Item 5) to 'F'.
5. Hold the equipment firmly and pull out the starter cable (Fig. 1b/Item 4) until you feel it begin to resist. Then tug sharply on the starter cable 4 times. The engine should start.
6. Once the engine has started, allow the equipment to warm up for 10 seconds.

⚠ CAUTION!

Never allow the starter line to snap back when it has been pulled out. This may result in damage.

⚠ CAUTION!

Since the choke (5) is closed, the cutting tool starts to operate immediately the engine is started.

7. Then release the choke (5) by actuating it once. Actuating the throttle lever will also release the choke lever. (The engine returns to its idle state). If the engine does not start up, repeat steps 5-6 above.



If the engine does not start up even after several attempts, read the section 'Malfunction and remedy (FAQ)' on page 39 of the user manual.

