

BISCUIT & JOINT GUIDE

8. BISCUIT SELECTION

Below is a table outlining the dimensions of the 3 common biscuits sizes which your biscuit joiner has preset depths for on the depth adjustment knob.

Biscuit	Width	Length
#0	16mm	44mm
#10	19mm	54mm
#20	25mm	60mm

Always try to use the largest biscuit that will fit. In most cases this will be #20. Occasionally, when using thin workpieces you will need to scale down to a #0 or #10 biscuit. Biscuits are typically 3.75mm thick and made from compressed beech wood shavings stamped out in an oval pattern.

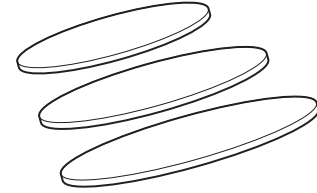

Glue is applied to the biscuit and the joint. The glue soaks into the biscuit causing it to swell and tighten up in the joint. The expansion of the biscuit adds strength to the joint.

Note: Always refer to the glue manufacturer's instructions regarding setting times.

Storage

Store your biscuits in a clean dry container. They can absorb moisture from the air and swell, rendering them useless.

9. TYPES OF JOINTS

Edge to Edge Joint

Edge-to-edge joinery is one of the easiest joints to construct. It is commonly used when making larger panels from smaller boards. One such application is a table top.

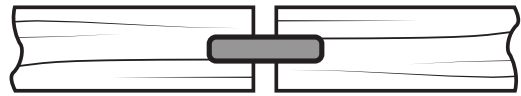

Butt Joint

A butt joint is one of the weakest joints in woodworking. This type of joint is mating the end grain of one board with the edge grain of another. The bonding of glue on this type of surface is poor. However, by using biscuits you can create a very strong joint that gives a mortise-and-tenon effect.

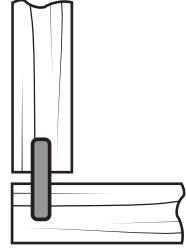

T-joint

A T-joint is used when the end of a board is joined to the face of another board. Typical applications for T-joints are attaching shelves to bookcases, or inner support braces to frames. Actual cutting of a T-joint is as simple as any other cut. However, it is critical that you mark the centrelines, mark the intersection points for each slot and cut each slot correctly.

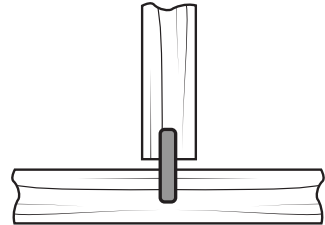

Mitre Joint

Mitre joints provide a neat finish to a corner joint as they do not show the end grain of the workpiece. Reinforcing the joint with the addition of a biscuit is a great way to add strength. Mitre joints are used when making boxes or drawers.

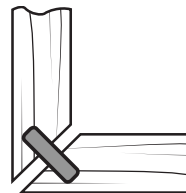

Corner Joint

Corner joints are used when making picture frames. Using biscuits for corner joints makes assembly much simpler. Clamping of corner joints can be difficult. The biscuit helps to hold the workpieces in place while the glue cures to secure the join.

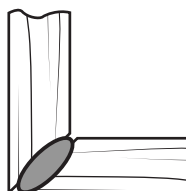

MAINTENANCE

WARNING! ENSURE THE BISCUIT JOINER IS SWITCHED OFF AND DISCONNECTED FROM THE POWER SUPPLY BEFORE PERFORMING ANY OF THE FOLLOWING TASKS.

Replacing the Blade

After extended use, the blade on your biscuit joiner may become dull and need replacing. If you accidentally hit a nail or other blunt object, it will break the carbide tips on the blade. These situations also require replacement of the blade.

Replacement Blade ACBJ-0001 can be ordered through the Special Orders Desk at any Bunnings store.

- Turn the joiner upside down and remove the 4 screws on the base with a screw driver.
- Depress the spindle lock with one hand and loosen the flange with the other using the pin spanner.

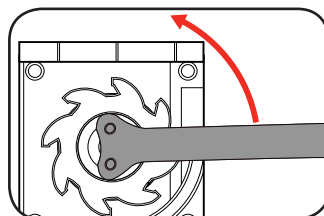
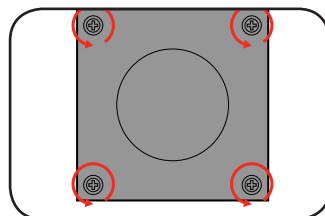

- Replace the blade, making sure the blade is in the same direction as the arrow on the gear case.
- Depress the spindle lock and tighten the flange with the pin spanner.

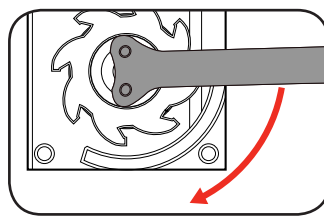
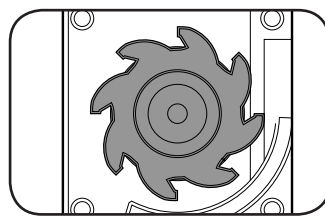

Emptying the Dust Bag

- To remove the dust and debris, simply unzip the zip at the back of the dust bag.

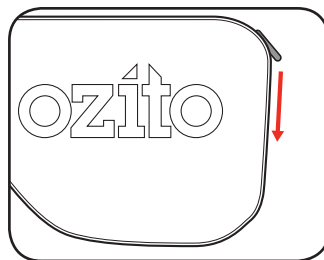

Cleaning

- Keep the ventilation vents of the joiner clean at all times, if possible, prevent foreign matter from entering the vents.
- After each use, blow air through the joiner housing to ensure it is free from all dust particles which may build up. Build up of dust particles may cause the joiner to overheat and fail.
- If the enclosure of the joiner requires cleaning, do not use solvents but a moist soft cloth only. Never let any liquid get inside the joiner; never immerse any part of the joiner into a liquid.
- The rails which the plunge run along must be kept free of dust and debris to ensure proper operation of your biscuit joiner.
- The grease in the gearbox will require replacement/replenishment after extensive use of the biscuit joiner. Please see your authorised service agent to provide this service.

Carbon Brushes

When the carbon brushes wear out, the joiner will spark and/or stop. Discontinue use as soon as this happens. They should be replaced prior to recommencing use of the joiner. Carbon brushes are a wearing component of the joiner therefore not covered under warranty. Continuing to use the joiner when carbon brushes need to be replaced may cause permanent damage to the joiner. Carbon brushes will wear out after many uses but when the carbon brushes need to be replaced, take the joiner to an electrician or a power tool repairer for a quick and low cost replacement. Always replace both carbon brushes at the same time.



Note: Ozito Industries will not be responsible for any damage or injuries caused by the repair of the joiner by an unauthorised person or by mishandling of the joiner.

TROUBLESHOOTING

Problem	Cause	Remedy
Plunge will not move forward to cut	Excessive build-up of sawdust in plunge rails	Clean plunge rails with compressed air to remove any sawdust and debris
Incorrect depth of cut	Misalignment of depth stop	Calibrate depth stop using the instructions in the setup section of this manual
Incorrect height of cut	Misalignment of height adjustment scale	Calibrate height adjustment scale
Workpiece smoking during cutting operation	Blade is blunt	Replace blade.
Sparking visible through housing air vents	Normal operation	It is normal for some sparking to be visible through the housing air vents during operation
Excessive sparking visible through housing air vents	Carbon brushes are worn	Replace brushes. This operation should be completed by an authorised service agent only.
Does not start	No supply voltage	Check the mains power, power cord, extension cord, plug and house fuse.
	On/Off switch broken	Contact Ozito customer service
	Carbon brushes are worn	Contact Ozito customer service
	Motor Defective	Contact Ozito customer service
Biscuit joiner works intermittently	Damaged electricity power cord	Check power cable. If damaged, contact Ozito customer service
	On/Off switch may be damaged	Contact Ozito customer service

SPARE PARTS

Spare parts can be ordered from the Special Orders Desk at your local Bunnings Warehouse or Homebase store.

For further information, or any parts visit

www.ozito-diy.co.uk or contact Ozito Customer Service:

Great Britain: 0151 294 4488

Ireland: 1850 882711

E-mail: enquires@ozito-diy.co.uk

DESCRIPTION OF SYMBOLS

V	Volts	Hz	Hertz
~	Alternating current	W	Watts
/min	Revolutions or reciprocation per minute	No	No load speed
	Read instruction manual		Warning
	Double insulated		Wear eye, breathing, ear protection

ELECTRICAL SAFETY

WARNING! When using mains-powered tools, basic safety precautions, including the following, should always be followed to reduce risk of fire, electric shock, personal injury and material damage. Read the whole manual carefully and make sure you know how to switch the tool off in an emergency, before operating the tool. Save these instructions and other documents supplied with this tool for future reference.

Before you connect the equipment to the mains supply make sure that the data on the rating plate are identical to the mains data.

This tool is double insulated therefore no earth wire is required.

If the supply cord is damaged, it must be replaced by an electrician or a power tool repairer in order to avoid a hazard.

Note: Double insulation does not take the place of normal safety precautions when operating this tool. The insulation system is for added protection against injury resulting from a possible electrical insulation failure within the tool.

Using an Extension Lead

Always use an approved extension lead suitable for the power input of this tool. Before use, inspect the extension lead for signs of damage, wear and ageing. Replace the extension lead if damaged or defective. When using an extension lead on a reel, always unwind the lead completely. Use of an extension lead not suitable for the power input of the tool or which is damaged or defective may result in a risk of fire and electric shock. To reduce the risk of electrical shock, we recommend the use of a residual current device (rated 30mA or less).

GENERAL POWER TOOL SAFETY WARNINGS

WARNING! Read all safety warnings and all instructions. Failure to follow the warnings and instructions may result in electric shock, fire and/or serious injury. Save all warnings and instructions for future reference. The term "power tool" in the warnings refers to your mains-operated (corded) power tool or battery-operated (cordless) power tool.

- Work area safety
 - Keep work area clean and well lit. Cluttered or dark areas invite accidents.
 - Do not operate power tools in explosive atmospheres, such as in the presence of flammable liquids, gases or dust. Power tools create sparks which may ignite the dust or fumes.
 - Keep children and bystanders away while operating a power tool. Distractions can cause you to lose control.
- Electrical safety
 - Power tool plugs must match the outlet. Never modify the plug in any way. Do not use any adapter plugs with earthed (grounded) power tools. Unmodified plugs and matching outlets will reduce risk of electric shock.
 - Avoid body contact with earthed or grounded surfaces, such as pipes, radiators, ranges and refrigerators. There is an increased risk of electric shock if your body is earthed or grounded.
 - Do not expose power tools to rain or wet conditions. Water entering a power tool will increase the risk of electric shock.
 - Do not abuse the cord. Never use the cord for carrying, pulling or unplugging the power tool. Keep cord away from heat, oil, sharp edges or moving parts. Damaged or entangled cords increase the risk of electric shock.
 - When operating a power tool outdoors, use an extension cord suitable for outdoor use. Use of a cord suitable for outdoor use reduces the risk of electric shock.
 - If operating a power tool in a damp location is unavoidable, use a residual current device (RCD) protected supply. Use of an RCD reduces the risk of electric shock.
- Personal safety
 - Stay alert, watch what you are doing and use common sense when operating a power tool. Do not use a power tool while you are tired or under the influence of drugs, alcohol or medication. A moment of inattention while operating power tools may result in serious personal injury.
 - Use personal protective equipment. Always wear eye protection. Protective equipment such as dust mask, non-skid safety shoes, hard hat, or hearing protection used for appropriate conditions will reduce personal injuries.
 - Prevent unintentional starting. Ensure the switch is in the off-position before connecting to power source and/or battery pack, picking up or carrying the tool. Carrying power tools with your finger on the switch or energising power tools that have the switch on invites accidents.
 - Remove any adjusting key or wrench before turning the power tool on. A wrench or a key left attached to a rotating part of the power tool may result in personal injury.

- Do not overreach. Keep proper footing and balance at all times. This enables better control of the power tool in unexpected situations.
- Dress properly. Do not wear loose clothing or jewellery. Keep your hair, clothing and gloves away from moving parts. Loose clothes, jewellery or long hair can be caught in moving parts.
- If devices are provided for the connection of dust extraction and collection facilities, ensure these are connected and properly used. Use of dust collection can reduce dust-related hazards.
- Power tool use and care
 - Do not force the power tool. Use the correct power tool for your application. The correct power tool will do the job better and safer at the rate for which it was designed.
 - Do not use the power tool if the switch does not turn it on and off. Any power tool that cannot be controlled with the switch is dangerous and must be repaired.
 - Disconnect the plug from the power source and/or the battery pack from the power tool before making any adjustments, changing accessories, or storing power tools. Such preventive safety measures reduce the risk of starting the power tool accidentally.
 - Store idle power tools out of the reach of children and do not allow persons unfamiliar with the power tool or these instructions to operate the power tool. Power tools are dangerous in the hands of untrained users.
 - Maintain power tools. Check for misalignment or binding of moving parts, breakage of parts and any other condition that may affect the power tool's operation. If damaged, have the power tool repaired before use. Many accidents are caused by poorly maintained power tools.
 - Keep cutting tools sharp and clean. Properly maintained cutting tools with sharp cutting edges are less likely to bind and are easier to control.
 - Use the power tool, accessories and tool bits etc. in accordance with these instructions, taking into account the working conditions and the work to be performed. Use of the power tool for operations different from those intended could result in a hazardous situation.
 - Service
 - Have your power tool serviced by a qualified repair person using only identical replacement parts. This will ensure that the safety of the power tool is maintained.

BISCUIT JOINER SAFETY WARNINGS

WARNING! This appliance is not intended for use by young of infirm persons unless supervised by a responsible person to ensure that they can use the appliance safely. Young children should be supervised to ensure that they do not play with the appliance.

Hold power tool by insulated gripping surface, because the cutter may contact its own cord. Cutting a "live" wire may make exposed metal parts of the power tool "live" and shock the operator. Use clamps or another practical way to secure and support the workpiece to a stable platform. Holding the work by hand or against the body leaves it unstable and may lead to loss of control.

Disc cutters must be rated for at least the speed marked on the tool. Disc cutters running over rated speed can fly apart and cause injury.

Always use the guard. The guard protects the operator from broken disc cutter fragments and unintentional contact with the disc cutter.

Using an Extension Lead

Always use an approved extension lead suitable for the power input of this tool. Before use, inspect the extension lead for signs of damage, wear and ageing. Replace the extension lead if damaged or defective.

When using an extension lead on a reel, always unwind the lead completely. Use of an extension lead not suitable for the power input of the tool or which is damaged or defective may result in a risk of fire and electric shock.

It is recommended that the extension lead is a maximum of 25m in length. Do not use multiple extension leads.

- Wear safety glasses or goggles when operating this tool.
- Do not use the tool in an inverted position.
- Do not attempt to use the tool in a stationary mode.
- Take special care when cutting MDF or surfaces coated with lead-based paint.
- Wear a dust mask specifically designed for protection against lead paint dust and fumes and ensure that persons within or entering the work area are also protected.
- Do not let children or pregnant women enter the work area.
- Do not eat, drink or smoke in the work area.
- Dispose of dust particles and any other debris safely.

ozito BISCUIT JOINER

1010W INSTRUCTION MANUAL

SPECIFICATIONS

Voltage:	230-240V - 50Hz
Power:	1010W
No Load Speed:	12,000/min
Blade Bore Diameter:	22mm
Max. Cutting Depth:	14mm
Fence Adjustment:	0 - 90°
Spindle Dimension:	M10
Weight:	3.25kg

ozito-diy.co.uk

3 YEAR REPLACEMENT WARRANTY

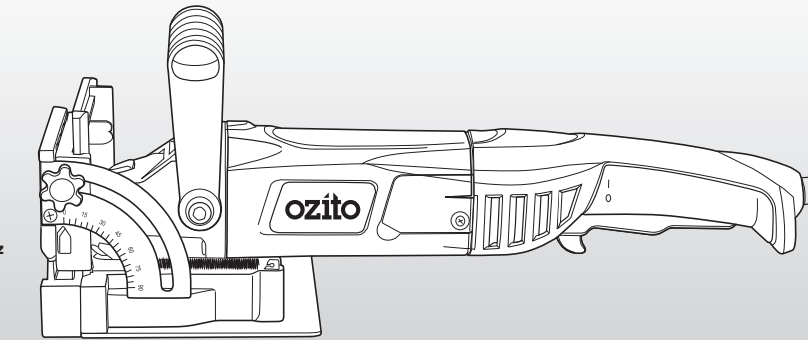

WHAT'S IN THE BOX

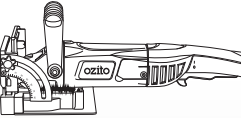

Biscuit Joiner



Pin Spanner



Dust Bag

BJK-1010U

WARRANTY

All of our products undergo strict quality checks to ensure that they reach you in perfect condition. In the unlikely event that your device develops a fault, please contact our service department at the address shown on this guarantee card. You can also contact us by telephone using the customer service number shown. Please note the following terms under which guarantee claims can be made:

1. These warranty terms regulate additional warranty services, which the manufacturer mentioned below promises to buyers of its new products in addition to their statutory guarantee claims are not affected by this guarantee. Our guarantee is free of charge to you.

2. The warranty services only covers defects due to material or manufacturing faults on a product which you have bought from the manufacturer mentioned below are limited to either the rectification of said defects on the product or the replacement of the product, whichever we prefer. Please note that our devices are not designed for use in commercial, trade or professional applications. A guarantee contract will not be created if the device has been used by commercial, trade or industrial business or has been exposed to similar stresses during the guarantee period.

3. The following are not covered by our guarantee:
 - Damage to the device caused by a failure to follow the assembly instructions or due to incorrect installation, a failure to follow the operating instructions (for example connecting it to an incorrect mains voltage or current type) or a failure to follow the maintenance and safety instructions or by exposing the device to abnormal environmental conditions or by lack of care and maintenance.
 - Damage to the device caused by abuse or incorrect use (for example overloading the device or the use of unapproved tools or accessories), ingress of foreign bodies into the device (such as sand, stones or dust, transport damage), the use of force or damage caused by external forces (for example by dropping it).

- Damage to the device or parts of the device caused by normal or natural wear or tear or by normal use of the device.

4. Your Product is guaranteed for a period of 36 months from the original date of purchase and is intended for DIY (Do It Yourself) use only. Lithium Ion batteries and chargers are covered by a 12 month warranty. Warranty excludes consumable parts. Guarantee claims should be submitted before the end of the guarantee period within two weeks of the defect being noticed. No guarantee claims will be accepted after the end of the guarantee period. The original guarantee period remains applicable to the device even if repairs are carried out or parts are replaced. In such cases, the work performed or parts fitted will not result in an extension of the guarantee period, and no new guarantee will become active for the work performed or parts fitted. This also applies if an on-site service is used.

IN ORDER TO MAKE A CLAIM UNDER THIS WARRANTY YOU MUST RETURN THE PRODUCT TO THE PLACE OF PURCHASE WITH YOUR REGISTER RECEIPT.

Please refer to the restrictions of this warranty concerning wearing parts, consumables and missing parts as set out in the service information in these operating instructions.

CUSTOMER SERVICE HELPLINE
 GB: 0151 294 4488
 IRL: 1850 882711
Ozito-diy.co.uk

KNOW YOUR PRODUCT

BISCUIT JOINER

- 1 Height Locking Knob
- 2 Depth Adjustment Dial
- 3 Spindle Lock
- 4 Secondary Handle
- 5 Dust Bag
- 6 Rear Handle
- 7 Fence
- 8 Centreline Indicator
- 9 Bevel Locking Knob
- 10 Bevel Adjustment Scale
- 11 Base
- 12 Lockoff Switch
- 13 On/Off Trigger

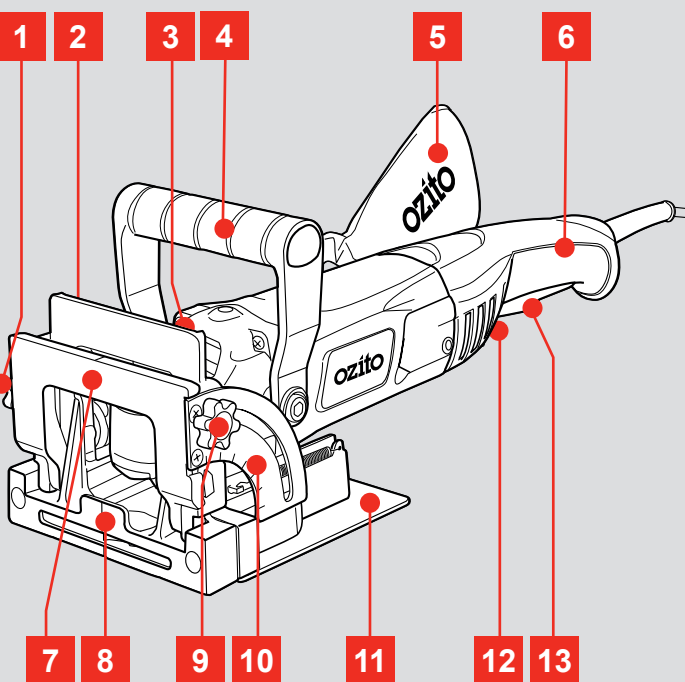

ACCESSORIES

14 Pin Spanner

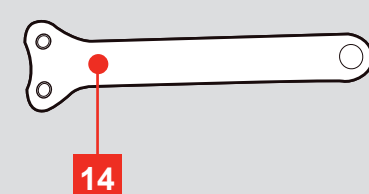

ONLINE MANUAL

Scan this QR Code with your mobile device to take you to the online manual.



SETUP & PREPARATION

1. ASSEMBLY

WARNING! ENSURE THE BISCUIT JOINER IS SWITCHED OFF AND DISCONNECTED FROM THE POWER SUPPLY BEFORE PERFORMING ANY OF THE FOLLOWING TASKS.

Attaching the Dust Bag

- Ensure the zip at the back of the dust bag is closed and that the clip on the dust bag is located in its recess.
- Align the flat edges on the dust bag and dust port. Then slide in firmly.

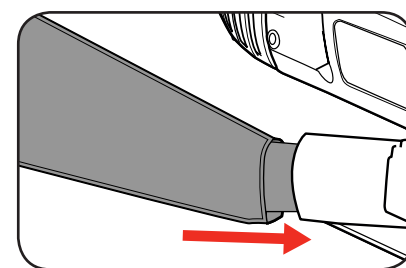
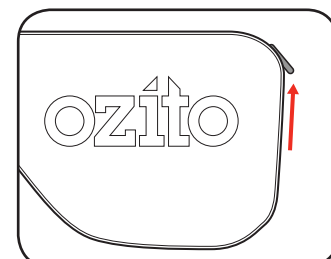

2. MARKING THE WORKPIECE

Centrelines

The centreline of the workpiece and the centreline of the biscuit must be lined up accurately to ensure a successful joint. The centreline marking procedure is outlined below.

- Measure the width of your workpiece with a square.
- Divide the measurement by 2 to get the midpoint. Mark this point several times along the workpiece with a pencil.
- Using a ruler, mark the centreline across the entire face of the workpiece.
- Using a square measure, mark a line 65mm from the edge of the workpiece.
- Using a square, draw a continuation of the centreline on the top of the workpiece for use when aligning the centreline indicator of your biscuit joiner.

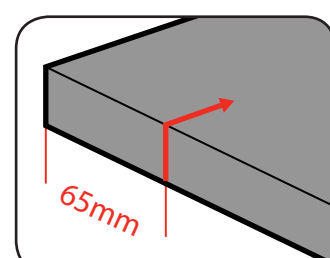
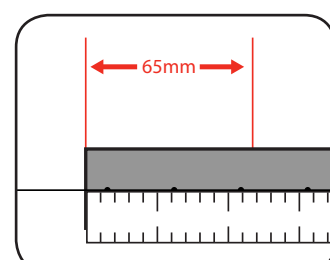
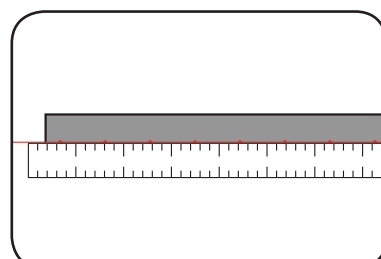
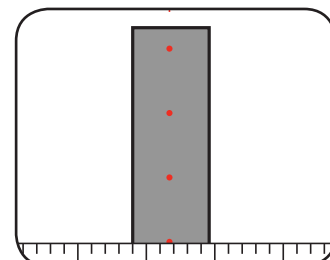
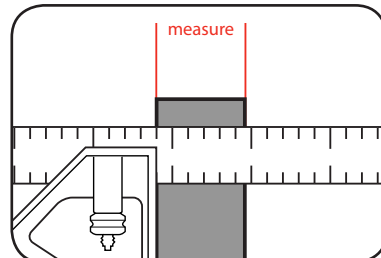

3. ADJUSTING THE CUTTING DEPTH

Adjusting the Cutting Depth

The depth adjustment dial controls the depth of the cut made in the workpiece as required for your biscuit.

- Rotate the depth adjustment dial so that it clicks into the desired setting.

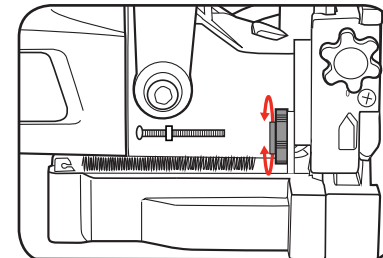

Your choice of biscuit is dictated by the size of the workpiece. The following table shows the relationship of the markings on the depth adjustment dial to cutting depth and the biscuit used.

Marking	Biscuit	Cutting Depth
0	#0	8mm
10	#10	10mm
20	#20	12.5mm
M	N/A	14mm (maximum)

Note: It is recommended to check the accuracy of the depth adjustment dial as part of your setup procedure.

Checking the Accuracy of the Depth Stop

- Set the depth adjustment dial using the procedure above, then extend the blade until the depth stop contacts the depth adjustment dial.
- Measure the distance between the blade and the face of the fence.
- To adjust the scale, rotate the depth stop screw until the depth of the blade matches the scale as outlined in the above table. Repeat this process for each depth setting.

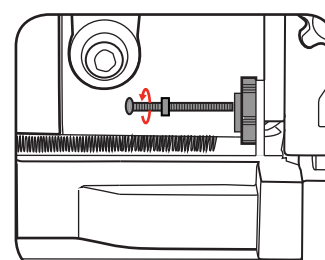
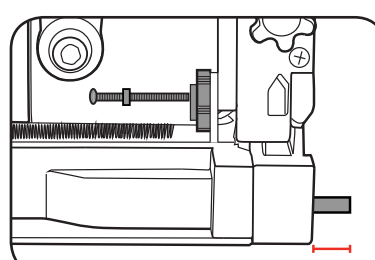
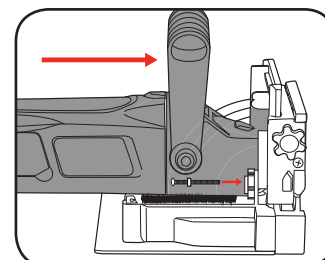

4. ADJUSTING THE ANGLE & HEIGHT

Adjusting the Cutting Angle

When using your biscuit joiner to make mitred joints, it is necessary to change the angle of cut to match the bevel for an accurate join.

- Loosen the bevel locking knob anti-clockwise.
- Move the fence to the desired angle on the bevel adjustment scale.

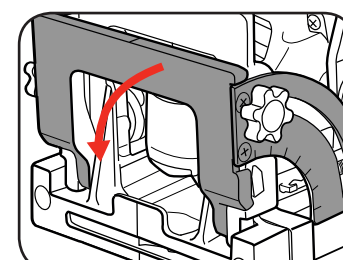
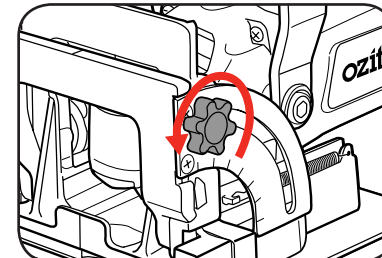

- Retighten the bevel locking knob securely by rotating it clockwise.

Adjusting the Height of the Fence

The height should correspond to half of the material thickness of the workpiece taking into account the width of the blade. The groove for the biscuit should always be in the middle of the workpiece, unless you are joining thick workpieces, where multiple adjacent biscuit joints are sometimes used.

- Loosen the height locking knob.
- Adjust the fence to the desired height using the height adjustment scale.

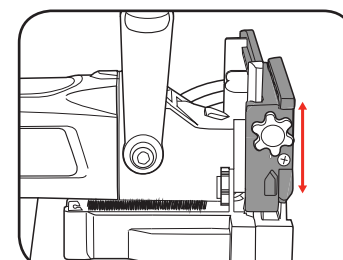
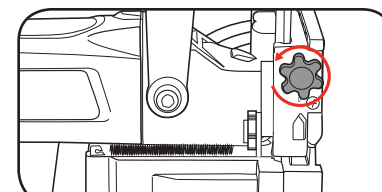

- Retighten the height locking knob securely by rotating it clockwise.

- Perform a visual check to ensure the centre of the blade lines up with the centreline you marked on the face of the workpiece and re-adjust if necessary.

Note: The indicator on the height adjustment scale measures the distance between the face of the fence and the centre of the blade.

Note: After completing this operation, double check the cutting angle to ensure the face of the fence is flush with the workpiece.

OPERATION

5. PRE-OPERATION CHECKS

WARNING! ENSURE THE BISCUIT JOINER IS SWITCHED OFF AND DISCONNECTED FROM THE POWER SUPPLY BEFORE PERFORMING ANY OF THE FOLLOWING TASKS.

- Ensure the joiner's plunge is moving freely along its rails.
- Check the disc carefully for cracks or damage and replace in necessary.
- Ensure the dust bag is secure and the zip is closed.
- Make sure the cutting depth, height and angle have been set to match the desired cut and material thickness.
- Clamp the workpiece securely so that it will not move during the cut.

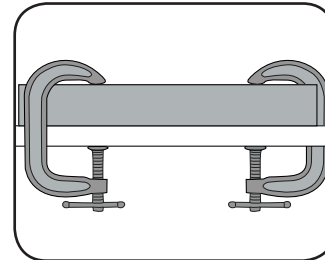
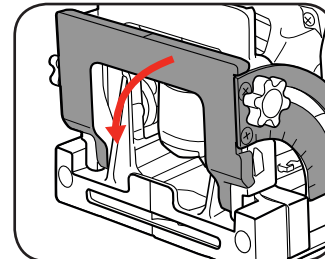
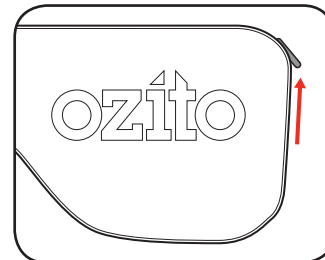
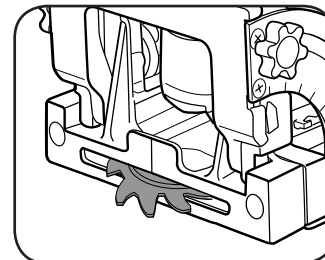
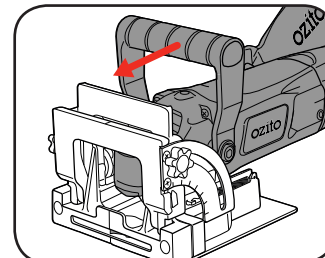

6. MAKING A CUT

CAUTION! TO REDUCE THE RISK OF ELECTRICAL SHOCK, WE RECOMMEND THE USE OF A RESIDUAL CURRENT DEVICE (RATED 30MA OR LESS).

- Plug the power cord into the power supply.
- Hold the biscuit joiner firmly using both handles.
- Place the fence flush against the workpiece and align the centreline indicator with the centreline marking on the workpiece.
- Push the lock off switch forward and depress the on/off trigger to start the tool.

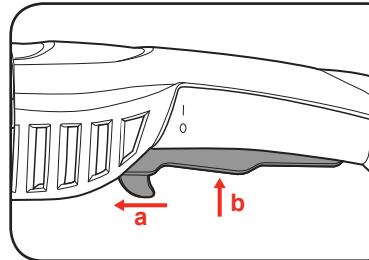
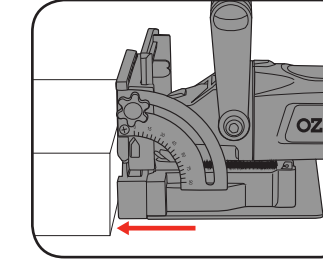
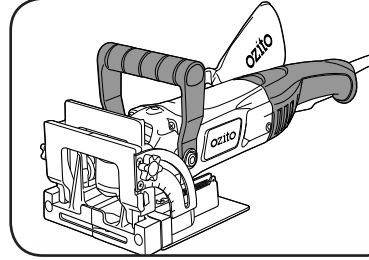
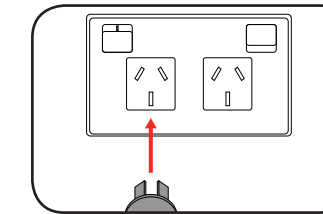

Note: Allow the biscuit joiner to reach maximum speed.

- Push the biscuit joiner forward to extend the blade into the workpiece.

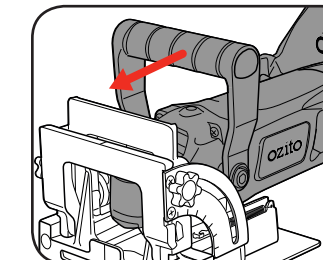

- Once the cut is complete allow the biscuit joiner blade to retract and then release the on/off trigger.

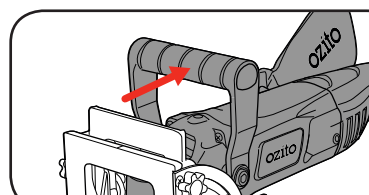

7. JOINING

- Once all biscuit slots have been cut, place a biscuit in each joint.
- Assemble the piece without glue first to ensure the workpieces line up and biscuits fit as required.
- Finally, disassemble the workpieces and place a bead of glue in each slot as well as over the entire joining face.
- Reinsert the biscuits and assemble the work pieces.
- Clamp the workpieces together until the glue sets.

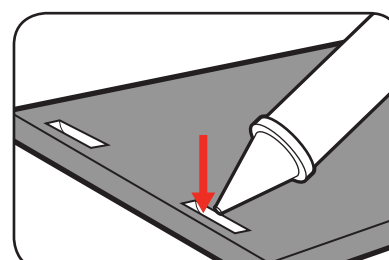
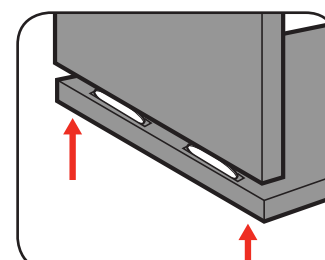
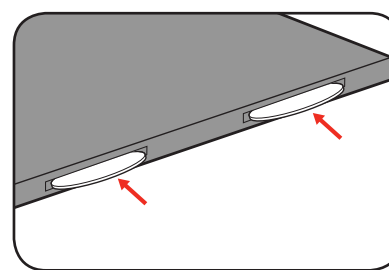

Note: If necessary, remove any pencil markings before applying glue.

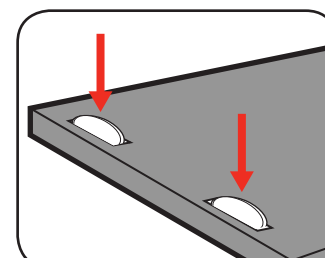

Note: Refer to the biscuit guide for more information relating to glue and biscuit joints.

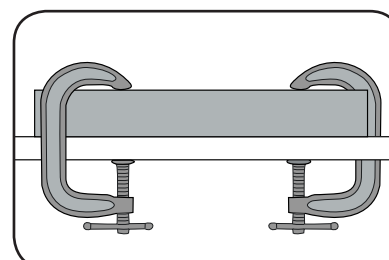

Note: Refer to the glue manufacturer's recommended setting times before removing the clamps.

3 YEAR REPLACEMENT WARRANTY